

# TASCAM

D01438920A

# Model 2400

## Multitrack Recording Console

### OWNER'S MANUAL

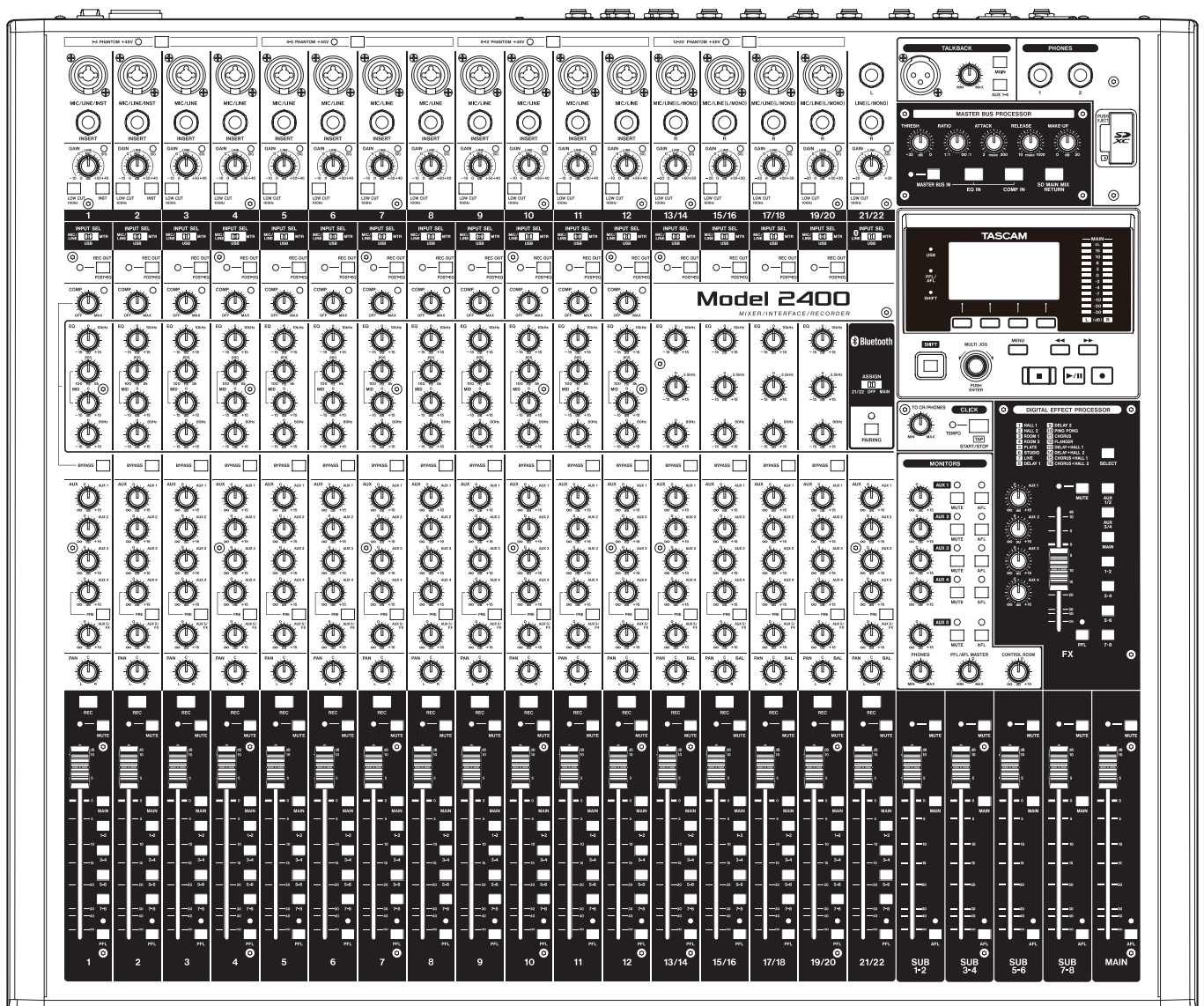

# Contents

<b>1 - Introduction</b> .....	<b>4</b>	Loading songs created on different TASCAM Model series products .....	28
Features .....	4	<b>5 - Basic recording</b> .....	<b>29</b>
Conventions used in this manual.....	4	Selecting the input source.....	29
Trademarks and copyrights.....	5	Setting the INPUT SEL switch.....	29
About SD cards.....	5	Setting phantom power .....	29
Precautions for use .....	5	Monitoring.....	29
SD card write protection .....	5	SIG indicators and level meters.....	30
Note about formatting.....	5	Recording.....	30
Bluetooth® .....	6	Undoing operations .....	31
Profiles.....	6	Undoing the previous operation.....	31
Codecs.....	6	Using the built-in effects .....	31
Content protection.....	6	Setting the built-in effect.....	31
Transmission security .....	6	Using the library .....	32
<b>2 - Names and Functions of Parts</b> .....	<b>7</b>	Making additional effect adjustments .....	33
Top panel.....	7	<b>6 - Recorder functions</b> .....	<b>34</b>
Input channel mixing section-1 .....	8	Locate function .....	34
Input channel mixing section-2.....	9	Changing the playback position .....	34
Talkback / headphone output jack / SD card slot section ..	10	Using the direct locate function to locate.....	34
MASTER BUS PROCESSOR section.....	11	Repeat playback function .....	34
Screen operation section .....	11	Punch in/out function .....	34
Monitoring section .....	12	Using the footswitch to punch in/out .....	34
Analog output adjustment section .....	13	Automatic punch in/out function .....	35
Rear panel.....	14	Setting the punch in/out points.....	35
Home Screen.....	15	Setting a pre roll point .....	35
Meters Screen .....	16	Rehearsing punching in and out.....	35
Meter Screen details.....	16	Using automatic punching in and out .....	36
Menu structure.....	17	<b>7 - Track editing</b> .....	<b>37</b>
Basic MENU screen operations .....	18	Clearing tracks.....	37
Menu operation procedures.....	18	Importing tracks .....	37
<b>3 - Preparation</b> .....	<b>19</b>	Swapping tracks .....	38
Connecting the power supply and other equipment.....	19	Normalization function.....	39
Connecting microphones .....	20	Using the normalization function .....	39
Connecting guitars, basses and similar instruments .....	20	Reversing normalization.....	39
Connecting electronic devices and other audio equipment.....	20	Mixing down.....	40
Connecting monitor speakers.....	20	Stereo mix export function.....	40
Connecting headphones.....	20	<b>8 - Mark functions</b> .....	<b>41</b>
Connecting a computer.....	20	Adding marks .....	41
Connecting with iOS devices.....	21	Moving between marks.....	41
Connecting with Bluetooth devices.....	21	Clearing individual marks.....	41
Inserting and removing SD cards.....	21	<b>9 - Other functions</b> .....	<b>42</b>
Inserting SD cards .....	21	Metronome functions.....	42
Removing SD cards.....	21	Setting the click sound.....	42
SD card write protection switches .....	21	Making metronome settings .....	43
Turning the power on and off.....	22	Setting the count in function .....	44
Setting the built-in clock date and time .....	22	Starting and stopping the metronome manually .....	44
Adjusting the display .....	23	Opening the METRONOME Screen with a function button .....	44
Adjusting the display contrast .....	23	MIDI functions .....	45
Adjusting the display brightness.....	23	Setting MIDI time code operation .....	45
Preparing an SD card for use.....	23	Setting MIDI CLOCK/SPP.....	45
<b>4 - Managing Songs</b> .....	<b>24</b>	Mixer functions .....	46
Viewing the song list.....	24	Selecting the output position of recording signals from the MAIN MIX L/R bus.....	46
Song Operation.....	24	Footswitch functions .....	47
Creating a New Song .....	25	Setting up the footswitch .....	47
Loading Songs.....	25	Setting the footswitch polarity .....	48
Saving the current song.....	25	DAW CONTROL.....	48
Viewing song information .....	26	Quick song creation function .....	48
Clearing all marks.....	26	MASTER BUS PROCESSOR functions .....	49
Deleting songs .....	26	Outputting signals from the MAIN OUTPUT jacks after they pass through the MASTER BUS PROCESSOR.....	49
Protecting/unprotecting songs .....	27		
Editing song names.....	27		
Editing text .....	27		

Setting the MASTER BUS PROCESSOR equalizer (master section equalizer).....	49
Setting the MASTER BUS PROCESSOR compressor (master section compressor).....	50
Using the SD MAIN MIX RETURN function .....	50
Using the library .....	50
<b>10 - Settings and Information.....</b>	<b>51</b>
Viewing information .....	51
CARD Screen .....	51
SONG Screen.....	51
SYSTEM Screen.....	51
Setting the song name format .....	51
Setting the WORD item.....	51
Restoring factory default settings.....	52
Formatting SD cards.....	52
Playing WAV files on SD cards (SD PLAY mode).....	53
<b>11 - Using a computer to transfer data .....</b>	<b>54</b>
Connecting with a Computer .....	54
Disconnecting .....	54
Loading WAV files from a computer .....	55
<b>12 - USB audio interface functions.....</b>	<b>56</b>
Installing the dedicated software .....	56
Installing the Windows dedicated software.....	56
Installing the Mac dedicated software.....	57
Working with Gatekeeper .....	57
Uninstalling the dedicated software.....	58
Uninstalling the Windows dedicated software .....	58
Uninstalling the Mac dedicated software .....	58
Opening the Settings Panel.....	58
Windows.....	58
Mac.....	58
Settings Panel overview.....	59
Notification function.....	60
Setting Sound Properties .....	60
Simultaneous ASIO/WDM playback .....	61
Make USB audio settings.....	61
Setting the USB audio mode.....	61
Setting the USB return channel function .....	62
Setting procedures for use with OBS Studio and other streaming applications .....	62
<b>13 - USB OUTPUT DELAY function .....</b>	<b>64</b>
Setting the delay time of the OUTPUT DELAY function ....	64
<b>14 - MIDI Implementation Chart.....</b>	<b>65</b>
<b>15 - Messages .....</b>	<b>66</b>
<b>16 - Troubleshooting .....</b>	<b>68</b>
<b>17 - Specifications.....</b>	<b>70</b>
Recorder specifications.....	70
Inputs and outputs .....	70
Analog audio input and output ratings .....	70
Control input/output.....	71
Operating system and computer requirements .....	71
Audio performance .....	72
Recording times.....	72
Bluetooth .....	72
Other.....	72
Dimensional drawings.....	73
Block diagram.....	74
Level diagram .....	75

# 1 - Introduction

Thank you very much for purchasing the TASCAM Model 2400 Multitrack Recording Console.

Before using this unit, read this Owner's Manual carefully so that you will be able to use it correctly and enjoy working with it for many years. After you have finished reading this manual, please keep it in a safe place for future reference.

You can also download this Owner's Manual from the TEAC Global Site (<https://teac-global.com/>).

---

## Features

---

- 22 input analog mixer with 22 line and 12 mic inputs
- Multitrack recording and playback with 24-track recording (input channels 1–12 and 13/14–21/22 and MAIN MIX L/R bus)
- USB audio interface functions built-in
  - 24 inputs (22 input channels and MAIN MIX L/R bus) can be input to a computer
  - 22 outputs and computer outputs can be assigned to channel inputs (channels 1–12 and 13/14–21/22)
  - Supports USB 2.0 audio with resolutions up to 24-bit and 48 kHz sampling frequency
- Ultra-HDDA mic preamps built-in (for channels 1–12)
- Phantom power (+48V) can be turned on/off in groups of 4 channels
- Mono input channels 1–12 have inserts, analog compressors and 3-band semi-parametric EQs
- Mono input channels 1–2 have TRS jacks that support high-impedance (Hi-Z) input
- Stereo input channels 13/14–19/20 have 3-band EQs
- REC-OUT (POST-EQ) switches enable recording audio with EQ
- BYPASS switches can be used to bypass COMP/EQ on channels
- Numerous buses include stereo main (MAIN MIX L/R) and stereo sub (SUB 1–2, 3–4, 5–6 and 7–8) buses
- 5 AUX sends include AUX 1, AUX 2, AUX 3, AUX 4 (Pre/Post) and AUX 5 (combined with FX)
- MASTER BUS PROCESSOR with 4-band digital equalizer and compressor on MAIN output
- MAIN OUTPUT has bus insert jacks
- Input channels and the FX return have PFL, and the AUX masters, SUB buses and MAIN have AFL
- TALKBACK jack connected to MAIN and AUX 1–4
- 100mm faders enable precise adjustments
- Track swap function that replaces tracks recorded on SD cards
- Punching in and out function per track (including punching in and out automatically and with footswitches)
- DAW transport control and track recording control functions with HUI/MCU emulation supported by major DAWs
- MIDI interface function enables MIDI keyboard input when using a DAW, output to connected MIDI sound sources, and output to drum machines and sequencers with MTC/MIDI CLOCK output
- 16 TASCAM preset effects support precise parameter adjustments
- CLICK output that supports TAP TEMPO
- Multiple footswitch functions available (select play/pause, effect muting or punch in/out)

- Audio playback and recording from devices connected by Bluetooth® supported
- Audio delay for USB output can be adjusted (0–2000 ms)
- 2 headphone output jacks
- Free Settings Panel app (Windows/Mac) includes a metering screen that can be adjusted for size

---

## Conventions used in this manual

---

In this manual, we use the following conventions:

- The four buttons under the display are called the function buttons. From left to right, they are shown as buttons **F1**, **F2**, **F3** and **F4**. Moreover, the functions at the bottoms of the screens will be shown after the button names.  
Examples: **F1** **METR** button, **F4** **MARK** button
- SD/SDHC/SDXC memory cards are referred to as “SD cards”.
- Computers, portable audio devices and other equipment connected to this unit using Bluetooth are called “Bluetooth devices”.
- Groups of recorded data are referred to as “songs”.
- The song that is currently selected is called the “current song”.
- Information shown on a computer display is written like this: “OK”.
- References to “iOS” in this document also include “iPad OS”.
- Additional information is introduced in the styles below when needed:

### TIP

These are tips about how to use the unit.

### NOTE

These provide additional explanations and describe special cases.

### ATTENTION

Failure to follow these instructions could result in damage to equipment or lost data, for example.

### ⚠ CAUTION

Failure to follow these instructions could result in injury.

## Trademarks and copyrights

- TASCAM is a registered trademark of TEAC Corporation.
- SDXC Logo is a trademark of SD-3C, LLC.



- The Bluetooth® word mark and logo are the property of Bluetooth SIG, Inc. and are used by TEAC Corporation with permission.
- Microsoft, Windows and Windows Media are either registered trademarks or trademarks of Microsoft Corporation in the United States and/or other countries.
- Apple, Mac, macOS, iPad, iPadOS and iTunes are trademarks of Apple Inc. in the United States and other countries.
- Lightning is a trademark of Apple Inc.
- App Store is a service mark of Apple Inc.
- IOS is a trademark or registered trademark of Cisco in the U.S. and other countries and is used under license.
- ASIO is a trademark of Steinberg Media Technologies GmbH.



- Other company names, product names and logos in this document are the trademarks or registered trademarks of their respective owners.

**Information is given about products in this manual only for the purpose of example and does not indicate any guarantees against infringements of third-party intellectual property rights and other rights related to them. TEAC Corporation will bear no responsibility for infringements on third-party intellectual property rights or other liabilities that occur as a result of the use of this product.**

**Properties copyrighted by third parties cannot be used for any purpose other than personal enjoyment and the like without the permission of the right holders recognized by copyright law. Always use this equipment properly. TEAC Corporation will bear no responsibility for rights infringements committed by users of this product.**

## About SD cards

This unit uses SD cards for recording and playback. This unit can use SD cards that are Class 10 or higher and compatible with SD, SDHC or SDXC standards.

A list of SD cards that have been confirmed for use with this unit can be found on our web site. Access this list from the product page of this product on the TEAC Global Site (<https://teac-global.com>) or contact the TASCAM customer support service.

### NOTE

When using external media (SD cards) with our products, we strongly recommend using media confirmed to work with them. Media that has not been confirmed to work with this product can be used, but unexpected problems could occur.

## Precautions for use

SD cards are delicate media.

In order to avoid damaging SD cards, please take the following precautions when handling them.

- Do not leave them in extremely hot or cold places.
- Do not leave them in extremely humid places.
- Do not let them get wet.
- Do not put things on top of them or twist them.
- Do not hit them.
- Do not remove or insert them during recording, playback, data transmission or other access.
- When transporting them, put them into cases, for example.

## SD card write protection

This unit writes track information to the media in order to improve operation performance. Since, for example, setting information cannot be written to SD cards that are writeprotected, settings will not be retained when the unit is restarted and performance will be otherwise affected.

## Note about formatting

SD cards formatted by this unit are optimized to improve performance during recording. Use this unit to format the SD cards to be used with it. Errors might occur when recording with this unit using an SD card formatted by a computer or other device.

# 1 - Introduction

---

## Bluetooth®

---

This unit has a built-in Bluetooth audio receiver, and can input sound played on a computer or portable audio device that supports Bluetooth (Bluetooth device).

### ATTENTION

The Bluetooth function of this unit is not guaranteed to enable connection or operation with all Bluetooth devices.

---

## Profiles

This unit supports the following Bluetooth profiles.

- A2DP (Advanced Audio Distribution Profile)

In order to transfer audio by Bluetooth, the Bluetooth device must support A2DP.

Even if a Bluetooth device supports the same profiles, though, its functions might differ according to its specifications.

---

## Codecs

This unit supports the following codecs. It will automatically select one of them during audio transfer.

- SBC
- AAC

The unit will select the appropriate codec to use according to the codec compatibility of the other Bluetooth device and communication conditions.

### NOTE

- You cannot select the codec to be used by pressing a button, for example.
- Due to characteristics of Bluetooth wireless technology, playback from this unit will be slightly delayed compared to playback from the Bluetooth device.

---

## Content protection

This unit supports SCMS-T as a form of content protection when transmitting audio, so it can play protected audio.

---

## Transmission security

This unit supports security functions during Bluetooth transmission in accordance with the Bluetooth standard specifications, but it does not guarantee the privacy of such transmissions.

TEAC CORPORATION will bear no responsibility should an information leak occur during transmission by Bluetooth.

# 2 - Names and Functions of Parts

## Top panel

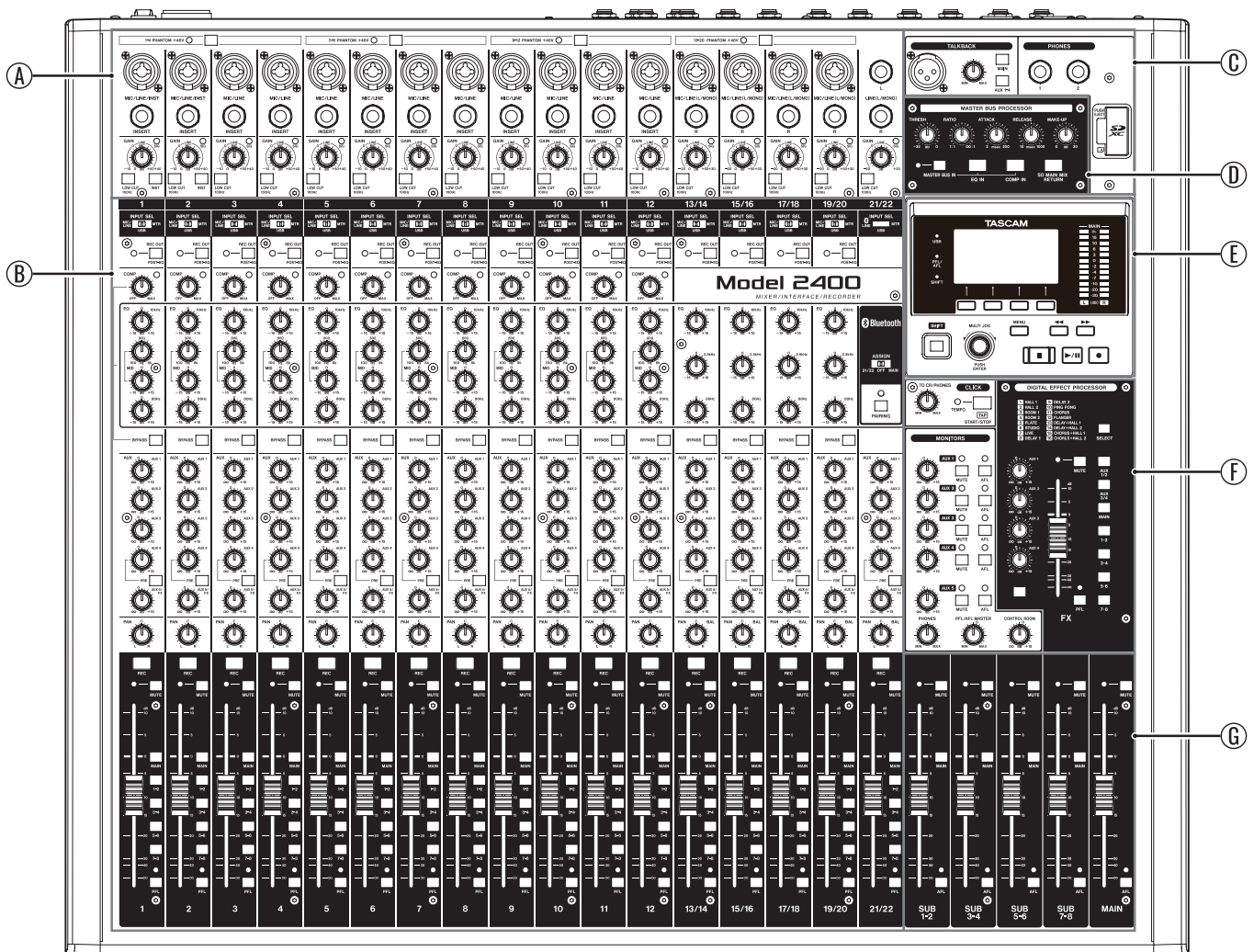

### A Input channel mixing section-1

Use this section to adjust the input levels of each channel.

### B Input channel mixing section-2

Use this section to choose input sources for each channel, adjust compressors and equalizers, and set levels sent to each bus (MAIN MIX L/R, PFL/AFL L/R, AUX 1-4, AUX 5/FX SUB 1-2 - 7-8). (see "Input channel mixing section-2" on page 9.)

### C Talkback / headphone output jack / SD card slot section

Control talkback, connect headphones and insert SD cards here. (see "Talkback / headphone output jack / SD card slot section" on page 10.)

### D MASTER BUS PROCESSOR section

Select the signal that is output from the MAIN OUTPUT jacks and set the MASTER BUS PROCESSOR compressor and equalizer here. (see "MASTER BUS PROCESSOR functions" on page 49.)

### E Screen operation section

Use this section to operate the meter, home and MENU screens shown on the display. (see "Screen operation section" on page 11.)

### F Monitoring section

Set the CLICK function and adjust the output levels from the AUX OUTPUT jacks (1-5) and the built-in effects, for example, here. (see "Monitoring section" on page 12.)

### G Analog output adjustment section

Adjust the output levels from the MAIN OUTPUT, SUB OUTPUT jacks in this section. (see "Analog output adjustment section" on page 13.)

## 2 - Names and Functions of Parts

### Input channel mixing section-1

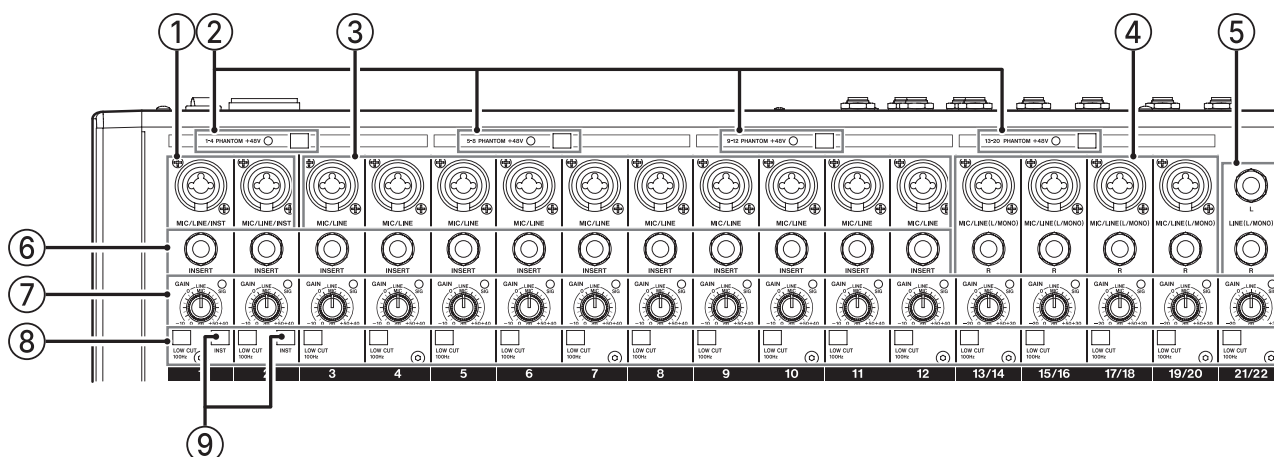

#### ① MIC/LINE/INST input jacks (1–2)

These analog inputs are XLR/TRS combo jacks.

- XLR (1: GND, 2: HOT, 3: COLD)
- TRS (Tip: HOT, Ring: COLD, Sleeve: GND)

The balanced XLR jacks are for XLR balanced mic input.

These standard TRS jacks are for line input.

When directly connecting a guitar, bass or other instrument, use a TRS jack and turn on (pushed in) the INST switch.

#### NOTE

When an INST switch is on, input through that MIC/LINE/INST input jack will be unbalanced.

#### ② PHANTOM +48V switch and indicator

Use this switch to supply +48V phantom power to the 1–4, 5–8 and 13/14–19/20 MIC input jacks on the top of the unit.

The indicator lights when the PHANTOM +48V switch is set to on (pushed in). (see "Setting phantom power" on page 29.)

#### ③ MIC/LINE input jacks (3–12)

These analog inputs are XLR/TRS combo jacks.

- XLR (1: GND, 2: HOT, 3: COLD)
- TRS (Tip: HOT, Ring: COLD, Sleeve: GND)

The balanced XLR jacks are for XLR balanced mic input.

These standard TRS jacks are for balanced line input.

#### ④ MIC/LINE (L/MONO) input jacks (13/14–19/20)

These XLR/TRS combo jacks and standard TRS jacks are stereo analog input jacks.

- XLR (1: GND, 2: HOT, 3: COLD)
- TRS (Tip: HOT, Ring: COLD, Sleeve: GND)

The balanced XLR jacks are for XLR balanced mic input.

These standard TRS jacks are for balanced line input. If only the L jack is connected, the same signal will be sent to both L and R channels.

#### ⑤ LINE (L/MONO) input jacks (21/22)

These standard TRS jacks are stereo line inputs.

If only the L jack is connected, the same signal will be sent to both L and R channels.

- TRS (Tip: HOT, Ring: COLD, Sleeve: GND)

#### ⑥ INSERT jacks (1–12, standard)

Use these standard TRS jacks to connect external devices (effects).

- TRS (Tip: SEND, Ring: RETURN, Sleeve: GND)

#### ⑦ GAIN knobs and SIG indicators (1–12, 13/14–21/22)

Use the GAIN knobs to adjust the input levels of each channel.

its SIG indicator will light green when a signal is input (–18 dBu or higher: MIC input).

If a SIG indicator stays lit red continuously, lower the GAIN knob (+7dBu or higher: MIC input).

#### ⑧ LOW CUT switches (1–12, 13/14–21/22)

Turn this switch on (pushed in) to enable low cut filters that cut noise and other sounds at low frequencies. (Cutoff frequency: 100 Hz)

#### ⑨ INST switches (1–2)

Set these according to the input sources of the MIC/LINE/INST (1–2) TRS input jacks.

Turn the INST switch on (pushed in) when connecting a guitar, bass or other equipment with high output impedance.

Turn the INST switch off (not pushed in) when connecting electronic instruments, audio devices, mics and other equipment.



## 2 - Names and Functions of Parts

### Input channel mixing section-2

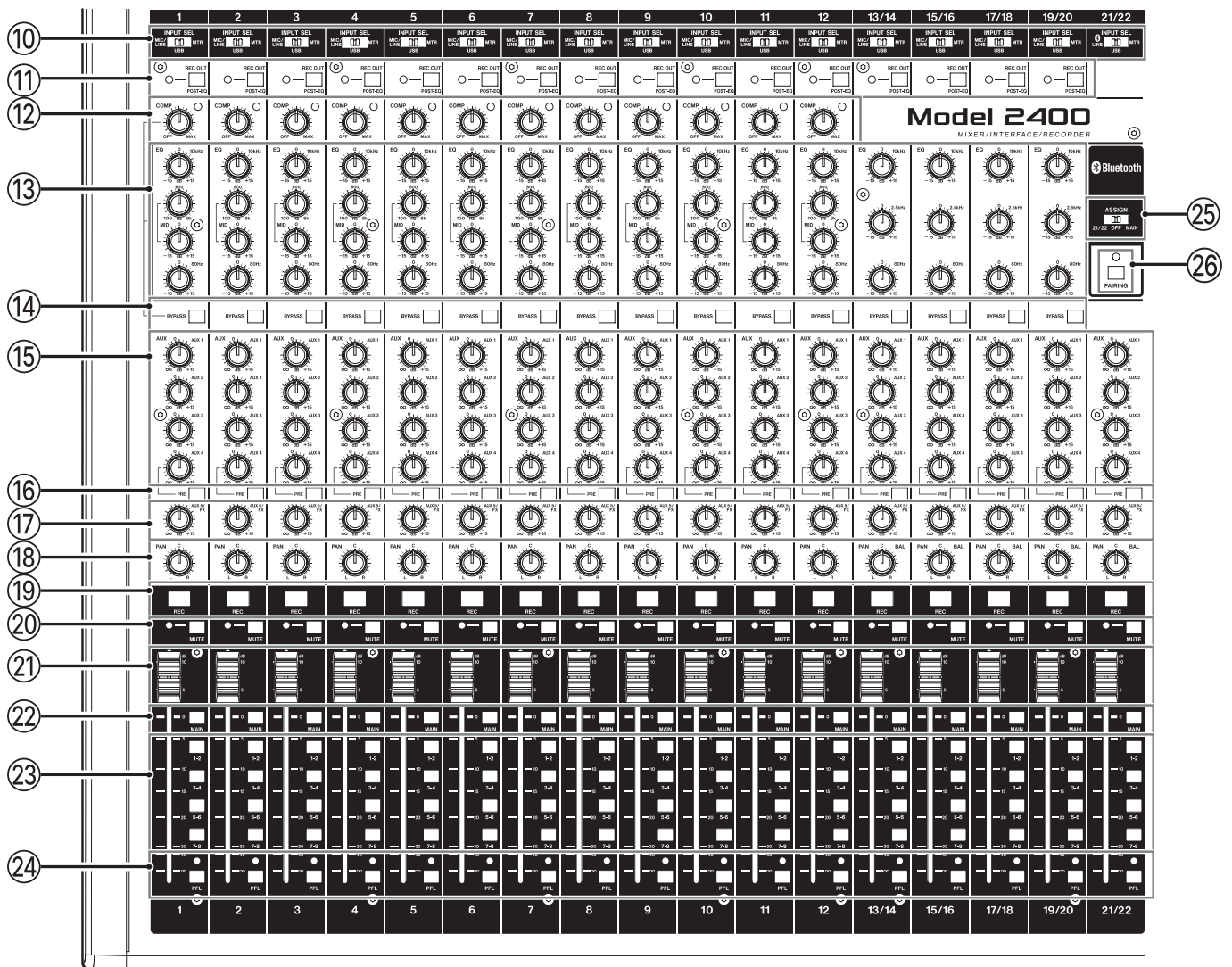

#### 10 INPUT SEL switches (1–12, 13/14–21/22)

Use these to select the input source for each channel. (see "Setting the INPUT SEL switch" on page 29.)

#### 11 REC OUT switches and indicators (1–12, 13/14–19/20)

When these switches are on (set to POST-EQ), the audio recorded to the SD card and sent by USB to the computer will be processed by the equalizer beforehand. (see "REC OUT switch function (channels 1–12, 13/14–19/20)" on page 46.)

#### 12 COMP knobs and indicators (1–12)

Use these knobs to adjust the compression thresholds for the signals input to each channel. When compression is being applied, the COMP indicators light.

#### 13 EQ knobs (1–12, 13/14–19/20)

- Use these to boost and attenuate the HIGH, MID and LOW bands of each channel.

Setting range: –15dB – +15 dB

#### 14 BYPASS switches (1–12, 13/14–19/20)

When these switches are on, the compressor and equalizer settings for the corresponding channels will not be applied.

#### 15 AUX 1–4 knobs (1–12, 13/14–21/22)

Use these to adjust the levels of the signals sent to the AUX 1–4 buses.

#### 16 AUX 4 PRE switches (1–12, 13/14–21/22)

When these switches are on, the signals sent to the AUX 4 bus, which are normally post-fader will become pre-fader.

#### 17 AUX 5/FX knobs (1–12, 13/14–21/22)

Use to adjust the levels of the signals sent to the AUX 5/FX bus (POST FADER).

## 2 - Names and Functions of Parts

### ⑱ PAN knobs (1–12, 13/14–21/22)

Use to adjust the stereo positions of the signals input to each channel.

#### NOTE

- When PAN knobs are centered (C), signals are reduced by 3 dB and sent to both left and right MAIN MIX L/R bus.
- When a PAN knob is turned all the way to the left (L), that channel signal is sent only to the left MAIN MIX L/R bus. It is not sent to the right bus.
- When a PAN knob is turned all the way to the right (R), that channel signal is sent only to the right MAIN MIX L/R bus. It is not sent to the left bus.

### ⑲ REC buttons and indicators (1–12, 13/14–21/22)

Use these to select the channels to record to the SD card.

- When these buttons are on (indicators blinking), those channels are in recording standby.
- When the indicators of these buttons are lit (without blinking), those channels are recording.

### ⑳ MUTE switches and indicators (1–12, 13/14–21/22)

When these switches are on (pushed in, MUTE indicator lit), those channels are muted.

### ㉑ Channel faders (1–12, 13/14–21/22)

Use these to adjust the send levels of channel signals.

### ㉒ MAIN switches (1–12, 13/14–21/22)

Turn these switches on (pushed in) to send channel signals to the MAIN MIX L/R bus.

### ㉓ SUB switches (1–12, 13/14–21/22)

Turn these switches on (pushed in) to send channel signals to the SUB buses.

### ㉔ PFL switches and indicators (1–12, 13/14–21/22)

Turn these switches on (pushed in) to send channel signals to the PFL/AFL L/R bus.

### ㉕ ASSIGN switch

Sound from the Bluetooth device is sent to channels 21/22 when this switch is set to "21/22" or the MAIN MIX L/R bus when it is set to "MAIN".

### ㉖ PAIRING button and indicator

Press and hold this button to activate Bluetooth pairing mode.

Press when pairing to end pairing mode. (see "Connecting with Bluetooth devices" on page 21.)

## Talkback / headphone output jack / SD card slot section

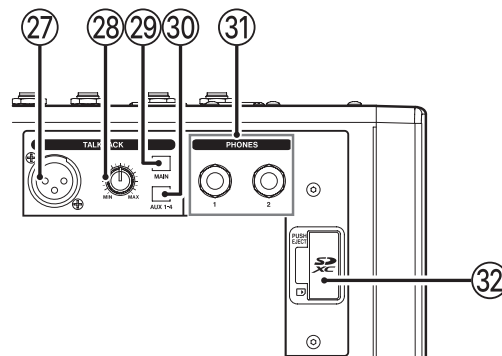

### ㉗ TALKBACK input jack

Connect a dynamic mic to use for talkback here.

### ㉘ TALKBACK volume

Use this to adjust the TALKBACK input level.

### ㉙ TALKBACK MAIN switch

Use this to send the TALKBACK audio to the MAIN MIX L/R bus.

### ㉚ TALKBACK AUX 1–4 switch

Use this to send the TALKBACK audio to the AUX 1–4 buses.

### ㉛ PHONES jack (1/2)

Use this standard stereo jack to connect stereo headphones. Use commercially-available adapters to connect headphones with mini plugs.

These can be used to monitor signals from the MAIN MIX L/R or PFL/AFL L/R buses. (see "Block diagram" on page 74.)

#### NOTE

The output levels of the 1 and 2 PHONES jacks cannot be adjusted individually.

### ㉜ SD card slot

Insert SD cards in this slot. (see "Inserting and removing SD cards" on page 21.)

## 2 - Names and Functions of Parts

### MASTER BUS PROCESSOR section

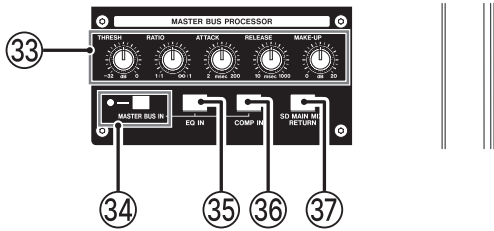

#### NOTE

See "MASTER BUS PROCESSOR functions" on page 49 for details about the MASTER BUS PROCESSOR.

- ③③ **MASTER BUS PROCESSOR compressor adjustment knobs**  
Use these to adjust the MASTER BUS PROCESSOR compressor.
- ③④ **MASTER BUS IN switch and indicator**  
When this switch is on, audio that has passed through the MASTER BUS PROCESSOR will be output from the MAIN OUTPUT jacks. The indicator lights when this switch is on.
- ③⑤ **EQ IN button/indicator**  
Use this to set the MASTER BUS PROCESSOR equalizer. (see "Setting the MASTER BUS PROCESSOR equalizer (master section equalizer)" on page 49.)
- ③⑥ **COMP IN button/indicator**  
Use this to set the MASTER BUS PROCESSOR compressor. (see "Setting the MASTER BUS PROCESSOR compressor (master section compressor)" on page 50.)
- ③⑦ **SD MAIN MIX RETURN button/indicator**  
Use this to switch on/off the SD MAIN MIX RETURN function.

#### ATTENTION

Be aware that when this switch is on (pushed in), the sound of the MAIN MIX L/R bus is not output.

### Screen operation section

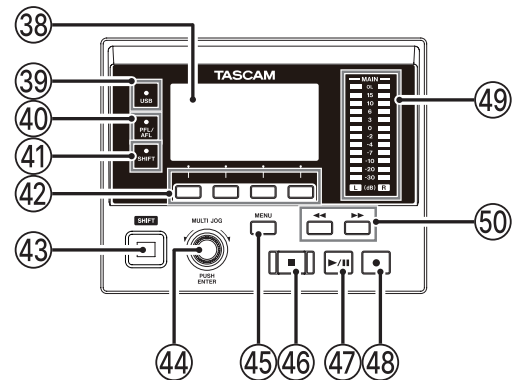

- ③⑧ **Display**  
Shows a variety of information.
- ③⑨ **USB indicator**  
This lights when the USB connection is working.
- ④① **PFL/AFL indicator**  
This indicator lights when a PFL switch is on for at least one channel or when an AFL switch for AUX 1–5 or the FX fader is on.
- ④① **SHIFT indicator**  
The SHIFT indicator lights when the SHIFT function is on.
- ④② **Function buttons**  
The functions of these buttons change depending on the screen shown on the display. The functions shown at the bottom of the display are the currently assigned functions.

#### NOTE

For convenience, the four buttons under the display are called the function buttons in this manual. From left to right, they are called the **F1**, **F2**, **F3** and **F4** buttons.

- ④③ **SHIFT button**  
To use an alternate function of a function button or other control, press and hold this button while operating that control.  
SHIFT lock status, which is the same as continuously pressing the SHIFT button, can be activated by briefly pressing the SHIFT button by itself.
- ④④ **MULTI JOG dial**  
This dial functions as a dial when turned and as a button when pressed.  
**Dial functions**
  - Turn when the Home Screen is open to move the file playback position. (see "Locate function" on page 34.)
  - When a MENU Screen is open, turn to select items and change setting values. (see "Basic MENU screen operations" on page 18.)**Button function**
  - Press when the Home Screen is open to designate a locate point. (see "Locate function" on page 34.)
  - When a Menu Screen is open, press to confirm selections and settings (ENTER button function).

## 2 - Names and Functions of Parts

### 45 MENU button

- When the Meter Screen is open, press to open the Home Screen.
- When the MENU Screen or a menu item settings screen is open, press to return to the Home Screen.
- When the Home Screen is open, press to open the MENU Screen. (See "Menu structure" on page 17 and "Basic MENU screen operations" on page 18.)

### 46 ■ button/indicator

Press to stop playback or recording.

This button lights when stopped.

Press this button when paused to return to the beginning of the song or file.

### 47 ►/|| button/indicator

Press this button to start playback.

Press to pause when playing.

This button lights during playback and recording.

This button blinks when paused.

### 48 ● button/indicator

Press this button to start recording.

This button lights during recording.

Press this button during playback to start recording (Manual punch in).

### 49 Output level indicators

These show the output levels of the MAIN OUTPUT jacks.

When the PFL/AFL indicator is lit, these show the output levels from the PFL/AFL L/R bus.

### 50 ◀◀/▶▶ buttons

- When stopped and during playback, press and hold these buttons to search backward/forward.
- When the Home Screen is open, press the ◀◀ button to locate to the beginning of the current song (00:00:00, which is the zero point).
- When the Home Screen is open, press the ▶▶ button to locate to the end of the current song.
- If the current song has auto punch in or out points set, you can also locate to those points.
- If the current song has marks set, these can also be used to locate to them.
- While pressing the ■ button, press the ◀◀ button to locate to the point where recording last started.
- While pressing the ■ button, press the ▶▶ button to locate to the point where recording last stopped.
- When the SD PLAY Screen is in playback state, press to skip a file. (see "Playing WAV files on SD cards (SD PLAY mode)" on page 53.)

## Monitoring section

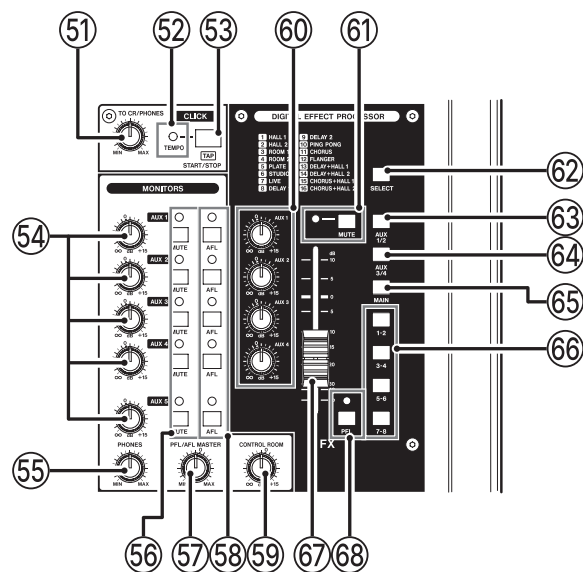

### 51 TO PHONES knob

Use this to adjust the level of the click sound sent to the headphone outputs.

### 52 TEMPO indicator

- This lights green when a song that has click sound output set is loaded.
- When the metronome is operating, it lights or blinks as follows. (see "Metronome functions" on page 42.)

Indicator color	Meaning
Red	This color lights on the first beat of the setting
Green	This blinks at the set tempo

### 53 CLICK button

- Press this button when the metronome is stopped to start it at the set tempo. Press this button when the metronome is on to stop it. (see "Starting and stopping the metronome manually" on page 44.)
- When the TAP TEMPO screen is open, tap this button repeatedly at the desired tempo to set the metronome. (see "Making metronome settings" on page 43.)
- When the EFFECT screen is open, tap this button repeatedly at the desired speed to set the delay of the built-in effect. (see "Setting the built-in effect" on page 31.)

### 54 AUX 1-5 knobs

Use these to adjust the output levels of the 1-5 AUX OUTPUT jacks.

## 2 - Names and Functions of Parts

### 55 PHONES knob

Use this to adjust the headphone output level.

#### ⚠ CAUTION

Before connecting headphones, minimize the volume with the PHONES knob. Failure to do so could result in a sudden loud noise that could harm hearing, for example.

#### NOTE

The output levels of the 1 and 2 PHONES jacks cannot be adjusted individually.

### 56 MUTE switches and indicators (AUX 1–5)

When these switches are on (indicators lit), signals to the corresponding AUX OUTPUT (1–5) jacks are muted.

### 57 PFL/AFL MASTER knob

Use this to adjust the send level from the PFL/AFL L/R bus.

### 58 AFL switches and indicators (AUX 1–5)

When these switches are on (indicators lit), the output signals of the AUX OUTPUT jacks (1–5) are sent to the PFL/AFL L/R bus.

#### NOTE

When these switches are on, the sound of the PFL/AFL L/R bus can be monitored with headphones.

### 59 CONTROL ROOM knob

Use to adjust the output levels of the CONTROL ROOM L/R jacks.

### 60 AUX knobs (FX)

Use these to adjust the levels of signals sent from the built-in effect processor to each AUX bus.

### 61 MUTE switch and indicator (FX)

When the MUTE switch are on (pushed in, MUTE indicator lit), the signal from the built-in effect is muted.

### 62 SELECT button

Open the EFFECT Screen and make built-in effect settings. (see "Using the built-in effects" on page 31.)

### 63 AUX 1/2 switch (FX)

When this switch is on, signals from the built-in effect processor are sent to the AUX 1–2 bus.

### 64 AUX 3/4 switch (FX)

When this switch is on, signals from the built-in effect processor are sent to the AUX 3–4 bus.

### 65 MAIN switch (FX)

When this switch is on, signals from the built-in effect are sent to the MAIN MIX L/R bus.

### 66 SUB 1–2/3–4/5–6/7–8 switches (FX)

When these switches are on, signals from the built-in effect processor are sent to the SUB buses.

### 67 FX fader

Use to adjust the levels of signals sent from the built-in effect to the following buses

- MAIN MIX L/R bus
- PFL/AFL L/R bus
- AUX 1–4 buses
- SUB buses

### 68 PFL switch and indicator

When this switch is on, signals from the built-in effect are sent to the PFL/AFL L/R bus.

## Analog output adjustment section

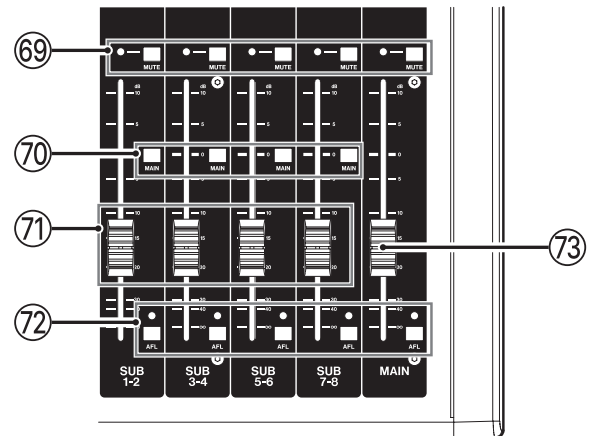

### 69 MUTE switches and indicators (SUB, MAIN)

When MUTE switches are on (MUTE indicators lit), signals to the SUB OUTPUT/MAIN OUTPUT jacks are muted.

### 70 MAIN switch (SUB)

When this switch is on (pushed in), the SUB OUTPUT jack output signal is sent to the MAIN MIX L/R bus.

### 71 SUB faders (1–2/3–4/5–6/7–8)

Use to adjust the output level of the SUB OUTPUT jacks.

### 72 AFL switches and indicators (SUB, MAIN)

When these switches are on, the output signals of the SUB OUTPUT or MAIN OUTPUT jacks are sent to the PFL/AFL L/R bus.

### 73 MAIN fader

Use to adjust the output level of the MAIN OUTPUT jacks.

## 2 - Names and Functions of Parts

### Rear panel

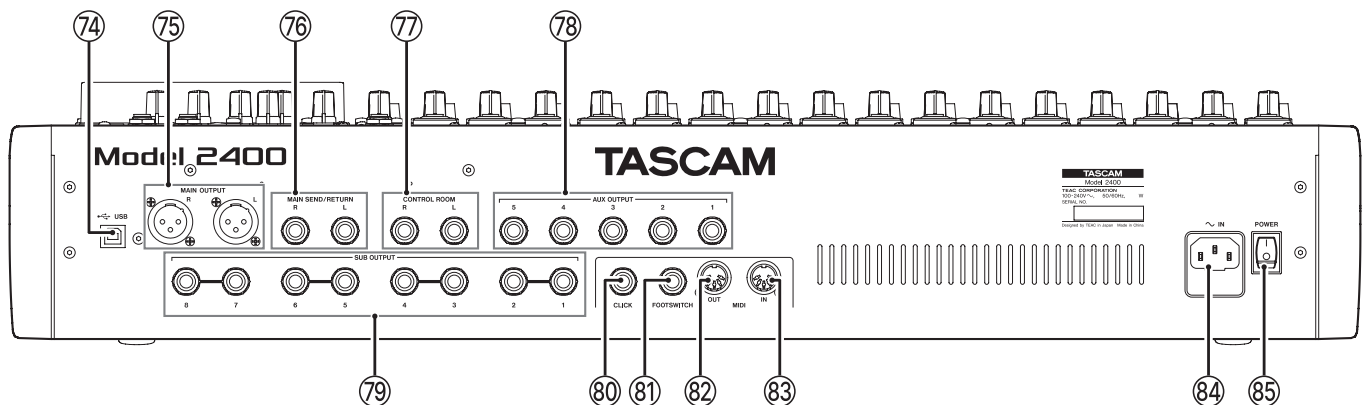

#### 74 USB port

This is a B-type USB port.

A USB cable can be used to connect this unit to a computer or iOS device. (see "Connecting with a Computer" on page 54.)

#### ATTENTION

The unit should be connected directly to the computer, not through a USB hub. Moreover, noise could be picked up if the cable is too long.

#### NOTE

Use a USB cable that is 2 m or less (USB-IF certification recommended).

#### 75 MAIN OUTPUT L/R jacks

These analog outputs are XLR jacks.

- XLR (1: GND, 2: HOT, 3: COLD)

#### 76 MAIN SEND/RETURN L/R jacks

Use these standard TRS jacks to connect an external device (effect processor) as an insert.

- TRS (Tip: SEND, Ring: RETURN, Sleeve: GND)

#### 77 CONTROL ROOM L/R jacks

This standard TRS jack is an analog output.

Use this to monitor signals from the MAIN MIX L/R bus or PFL/AFL L/R bus.

- TRS (Tip: HOT, Ring: COLD, Sleeve: GND)

#### 78 AUX OUTPUT jacks (1–5)

These standard TRS jacks are analog outputs.

- TRS (Tip: HOT, Ring: COLD, Sleeve: GND)

#### ATTENTION

When AUX OUTPUT jack 5 is in use, the built-in effect processor cannot be used. (see "Using the built-in effects" on page 31.)

#### 79 SUB OUTPUT jacks (1–2/3–4/5–6/7–8)

These standard TRS jacks are analog outputs.

- TRS (Tip: HOT, Ring: COLD, Sleeve: GND)

#### 80 CLICK jack

This outputs the metronome click sound. (see "Setting the click sound" on page 42.)

#### 81 FOOTSWITCH jack

This standard TRS jack is for connecting a footswitch.

- TRS (Tip: FOOTSW1, Ring: FOOTSW2, Sleeve: GND)

#### NOTE

- This unit was designed to be used with unlatched (momentary) footswitches that have to be pushed to function (shorted when pushed). (see "Setting the footswitch polarity" on page 48.)

- Two footswitches can be connected by using a commercially-available Y-cable.

#### 82 MIDI OUT connector

This 5-pin DIN is a standard MIDI output connector.

This outputs MIDI data sent from the computer.

If the MIDI TIMECODE or MIDI CLOCK/SPP items are set to ON on the MIDI screen, those will also be output. (see "MIDI functions" on page 45.)

#### 83 MIDI IN connector

This 5-pin DIN is a standard MIDI input connector.

MIDI data input through this connector will be sent to the computer.

#### 84 AC IN connector

Connect the included power cord here.

#### 85 POWER switch

Press to turn the unit on and off.

#### CAUTION

Before turning the power on or off, minimize the volumes of connected equipment. Failure to do so might cause sudden loud noises, which could harm your hearing or result in other trouble.

#### ATTENTION

Do not turn off the power when the unit is operating (including recording, playing back, or writing data to an SD card). Doing so could cause proper recording to fail and recorded data to be lost.

## Home Screen

When the Meter Screen is open, press the MENU button to open the Home Screen.

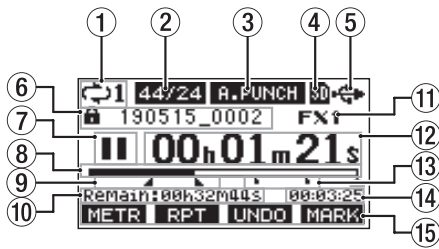

### ① Repeat playback status

An icon appears when the repeat playback function is on. (see "Repeat playback function" on page 34.)

### ② Song format

This shows the current song file format.

- 44/16 44.1 kHz, 16bit
- 44/24 44.1 kHz, 24bit
- 48/16 48 kHz, 16bit
- 48/24 48 kHz, 24bit

#### NOTE

If no song is loaded, the operation format of the unit will be shown like 44/24 or 48/24.

### ③ Automatic punch in/out function on/off status

The A.PUNCH icon appears when the automatic punch in/out function is on. (see "Automatic punch in/out function" on page 35.)

### ④ SD card present status

When an SD card is loaded, the SD icon appears. When an SD card is protected, a lock icon appears. Since system files cannot be updated when the lock icon appears, automatic punch in/out settings will not be retained and previously loaded songs will not be loaded when the unit is turned on again.

### ⑤ USB connection status

During USB connection, the USB icon appears. An DLY icon appears on the Home Screen when the OUTPUT DELAY function is on (set to ENABLE). (see "13 - USB OUTPUT DELAY function" on page 64.) A 2/23 or 1/8P icon appears when the USB return channel function is being used. (see "Setting the USB return channel function" on page 62.)

### ⑥ Song name

This shows the name of the current song. If a song is protected, a lock icon appears before the file name. (see "Protecting/unprotecting songs" on page 27.) If a song has unsaved marks, an FX icon appears before the file name. (see "Adding marks" on page 41.)

### ⑦ Transport status

This icon shows the recorder operation status.

Indicator	Meaning
■	Stopped at the beginning of the file
	Paused
●	Recording
▶	Playback

### ⑧ Playback position

The current playback position is shown by a bar.

### ⑨ Automatic punch in/out point setting status

When the automatic punch in/out function is on, these show the status of automatic punch in/out point setting.

- ▶ Punch in point
- ◀ Punch out point

### ⑩ Remaining time

The remaining time available for recording on the SD card is shown (in hours: minutes: seconds).

#### NOTE

The remaining time that can be recorded on an SD card varies according to the number of recording channels, song format and SD card capacity.

### ⑪ Built-in effect status

When a built-in effect is on, the number of the effect in use is shown.

An FX.MUTE icon appears when the built-in effect processor has been turned off using a footswitch.

### ⑫ Recorder time counter

This shows the elapsed time from the beginning of the song.

### ⑬ Mark indicators

An lock icon is shown at each mark.

### ⑭ Song length

This shows the length of the current song (in hours: minutes: seconds).

### ⑮ Function button functions

This shows the functions assigned to the function button on the Home Screen.

- F1 METR button: This opens the Meter Screen.
- F2 RPT button: This turns the repeat playback function on/off.
- F3 UNDO button: This returns to the state before the previous operation.
- F3 REDO button: This restores the state after the previous operation.
- F4 MARK button: This adds/deletes marks.
- SHIFT + F1 NEW button: This creates a new song (quick song creation function).
- SHIFT + F4 CLIC button: This opens the METRONOME Screen where the metronome function can be set.

#### NOTE

The F3 button UNDO and REDO indicators appear when those operations are possible.

## 2 - Names and Functions of Parts

### Meters Screen

This shows the levels of the signals being input to the unit.

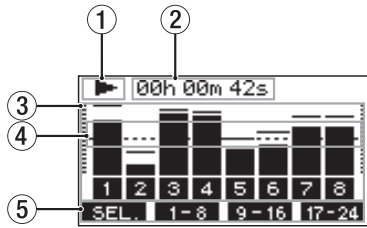

#### ① Transport status

This icon shows the recorder operation status.

#### ② Recorder time counter

This shows the elapsed time from the beginning of the song.

#### ③ Track level meters

These show the signal levels of each channel.

#### NOTE

The **MAIN** channels show the MAIN MIX L/R bus levels.

#### ④ Level meter guide

This provides guidance for level adjustment. The guide is shown at the  $-18\text{dB}$  level.

#### ⑤ Function button functions

This shows the functions assigned to the function button on the Meter Screen.

- **F1 SEL** button: Press to change the input sources shown on the Meter Screen.
- **F2 1-8** button: Press to show the level meters for channel 1-8 signals on the Meter Screen.
- **F3 9-16** button: Press to show the level meters for channel 9-16 signals on the Meter Screen.
- **F4 17-24** button: Press to show the level meters for channel 17-22 signals and **MAIN** channel signals on the Meter Screen.

### Meter Screen details

When the Meter Screen is open, press the **F1 SEL** button to change the signal sources shown by the meters.

### Channel input level screens

The levels of signals input on each channel are shown depending on their INPUT SEL switch settings.

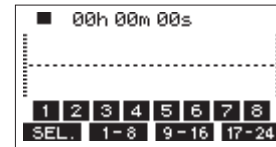

### MIC/LINE INPUT Screen

This shows the levels of signals being input to the input jacks.

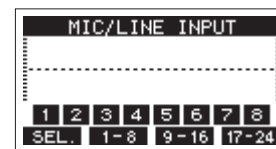

### USB RETURN Screen

This shows the levels of signals output from a computer when used as a USB audio interface.

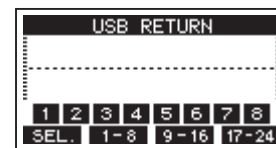

#### NOTE

Output from the computer, including from Windows Media Player and iTunes, is sent to channels 1-2.

### MTR RETURN Screen

This shows the playback signal levels of songs recorded on SD cards.

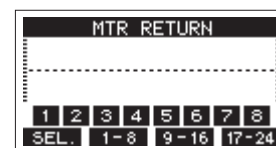

- ① ② ③ ④ Channels that have recording data in the song
- ① ② ③ ④ Channels that do not have recording data in the song



## 2 - Names and Functions of Parts

### Menu structure

When the Home Screen is open, press the MENU button to open the MENU Screen.  
The various menu items are as follows.

Menu item		Function	Page	
SONG		SONG Work with songs on an SD card	page 24	
CLICK	SETTING	Set click sound operation and output destination	page 42	
	METRONOME	Make specific metronome settings	page 43	
	COUNT IN	Set the count in function	page 44	
MTR	TRACK EDIT	TRACK CLEAR	Clear specific tracks or all tracks	page 37
		IMPORT	Import chosen WAV files to song tracks	page 37
		TRACK SWAP	Swap song recording files	page 38
		NORMALIZE	Use the normalize function	page 39
	AUTO PUNCH		Set the auto punch in/out function	page 35
	A.PUNCH PRE ROLL		Set the pre-roll point	page 35
MIDI	MIDI TIMECODE	Set the MIDI time code	page 45	
	MIDI CLOCK/SPP	Set MIDI clock and song position pointer	page 45	
MIXER	MASTER EQ	Set the MASTER EQ	page 49	
	MASTER COMP	Check the MASTER COMP level and other settings	page 50	
	MAIN REC POS	Set the MAIN MIX L/R bus signal that is recorded to the SD card	page 46	
STEREO MIX EXPORT		Use stereo mix export function	page 40	
SD PLAY		Play WAV files on an SD card	page 53	
STORAGE		SD cards can be accessed from a computer	page 54	
DAW CONTROLLER		Set the DAW control mode	page 48	
SYSTEM	INFORMATION		View information about SD cards, songs and the system	page 51
	DATE/TIME		Date and time settings	page 22
	SONG NAME		Set the song name format	page 51
	DISPLAY		Adjust the display	page 23
	FOOTSW		Make footswitch settings	page 47
	USB AUDIO	PC ←	Set the USB audio mode	page 61
		PC CH1/2 →	Set the USB return channel function	page 62
	USB OUTPUT DELAY		Set the OUTPUT DELAY function	page 64
	INITIALIZE		Restore factory default settings	page 52
	MEDIA FORMAT		Format the SD card	page 52

#### NOTE

The settings for all menu items are retained even when the unit is turned off.

## 2 - Names and Functions of Parts

### Basic MENU screen operations

After using the MENU button to open the MENU Screen, it can be operated in the following manner.

This is an overview of basic operations. Function button assignments differ according to the screen shown on the display.

#### Selecting items (moving vertically on a page):

Turn the MULTI JOG dial.

#### Opening a submenu from a page:

Press the MULTI JOG dial.

#### Confirming a selected item:

Press the MULTI JOG dial (ENTER button function).

#### Returning to the previous screen without confirming the selected item:

Press the **F1 EXIT** button.

#### NOTE

Some menu items are confirmed as soon as they are selected.

#### Going back one step in a menu:

Press the **F1 EXIT** button.

#### Returning to the Home Screen from a MENU Screen:

Press the **F1 HOME** button.

### Menu operation procedures

This explanation uses an example of setting the pre-roll point.

1. Press the MENU button to open the Home Screen.

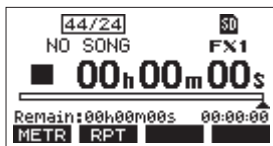

2. Press the MENU button to open the MENU Screen.

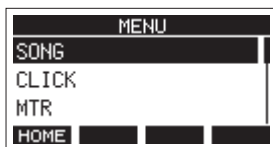

#### NOTE

Press the **F1 HOME** button to return to the Home Screen.

3. Turn the MULTI JOG dial to select different menu items.

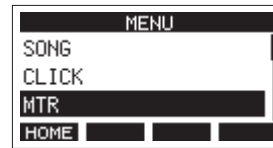

4. Press the MULTI JOG dial to open a settings screen.

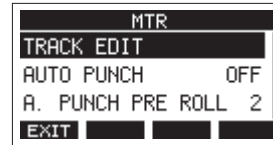

5. Turn the MULTI JOG dial to select the menu item to set.

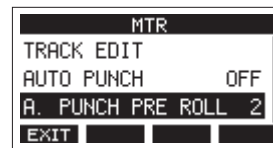

A.PUNCH PRE ROLL selected

6. Press the MULTI JOG dial to open the settings screen.

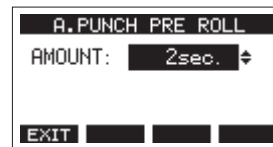

A.PUNCH PRE ROLL Screen open

7. Turn the MULTI JOG dial to change the setting.

#### NOTE

To cancel a setting change, press the **F1 EXIT** button.

8. To set another item on the same screen, press the MULTI JOG dial to move the cursor to the next setting.
9. Repeat steps 3 to 8 as necessary to set other items.
10. Press the **F1 EXIT** button to return to the MENU Screen.

## Connecting the power supply and other equipment

This is an example of Model 2400 connections.

### Precautions before making connections

- Carefully read the operation manuals of the devices to be connected and then connect them correctly.
- Before making connections, turn this unit and all equipment to be connected off (standby).
- Install all connected devices, including this unit, so that they are powered from the same line. When using a power strip or similar device, be sure to use one that has high current capacity (thick cable) in order to minimize fluctuations in power voltage.
- Before connecting audio equipment, set the following knobs and faders to their lowest values. Failure to do so could cause sudden loud noises from monitoring equipment, and this could damage the equipment or harm hearing.
  - GAIN knobs (channels 1–12, 13/14–21/22)
  - Channel faders (channels 1–12, 13/14–21/22)
  - SUB faders (SUB 1–2, 3–4, 5–6, 7–8)
  - AUX 1–4 and AUX 5/FX knobs
  - MAIN fader
  - PHONES knob
  - CONTROL ROOM knob
- Set the PHANTOM +48V switch to off.

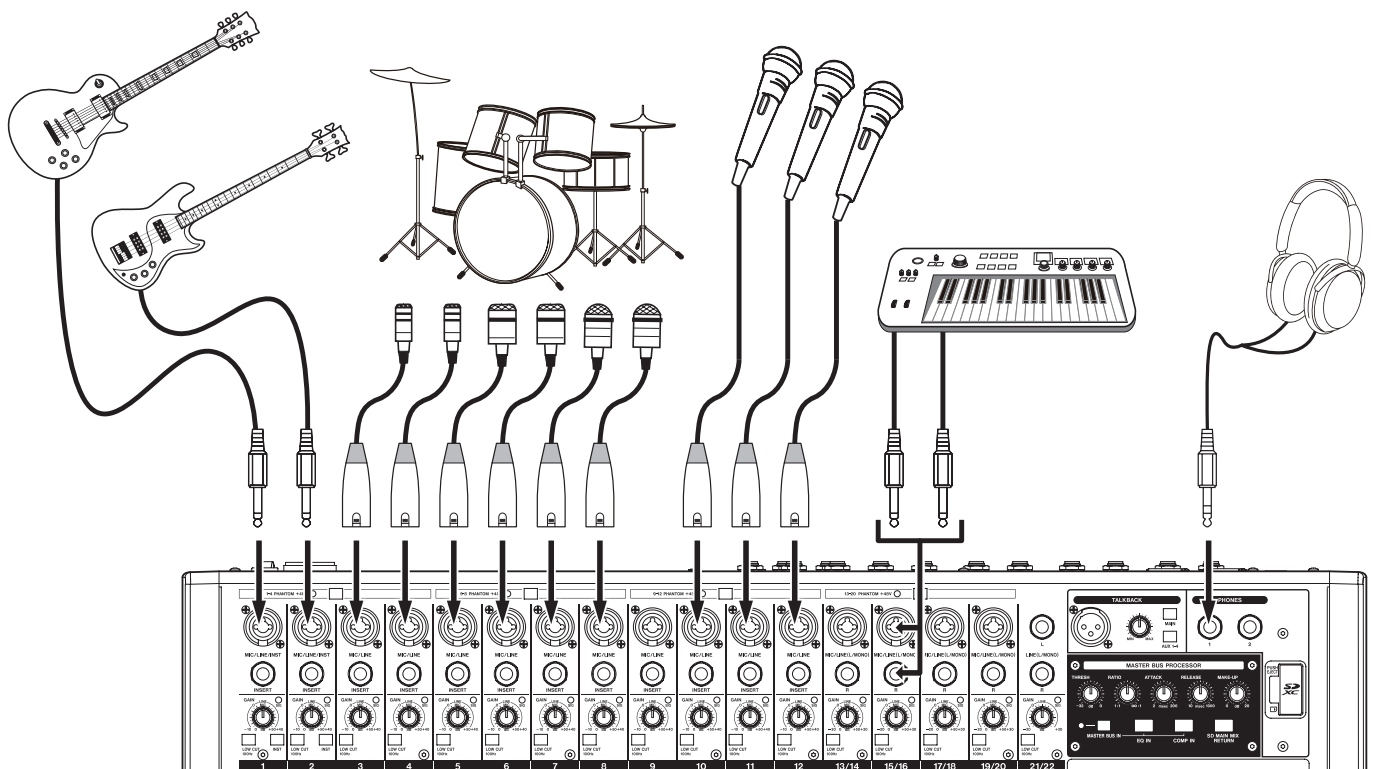

Examples of connections to a Model 2400

## 3 - Preparation

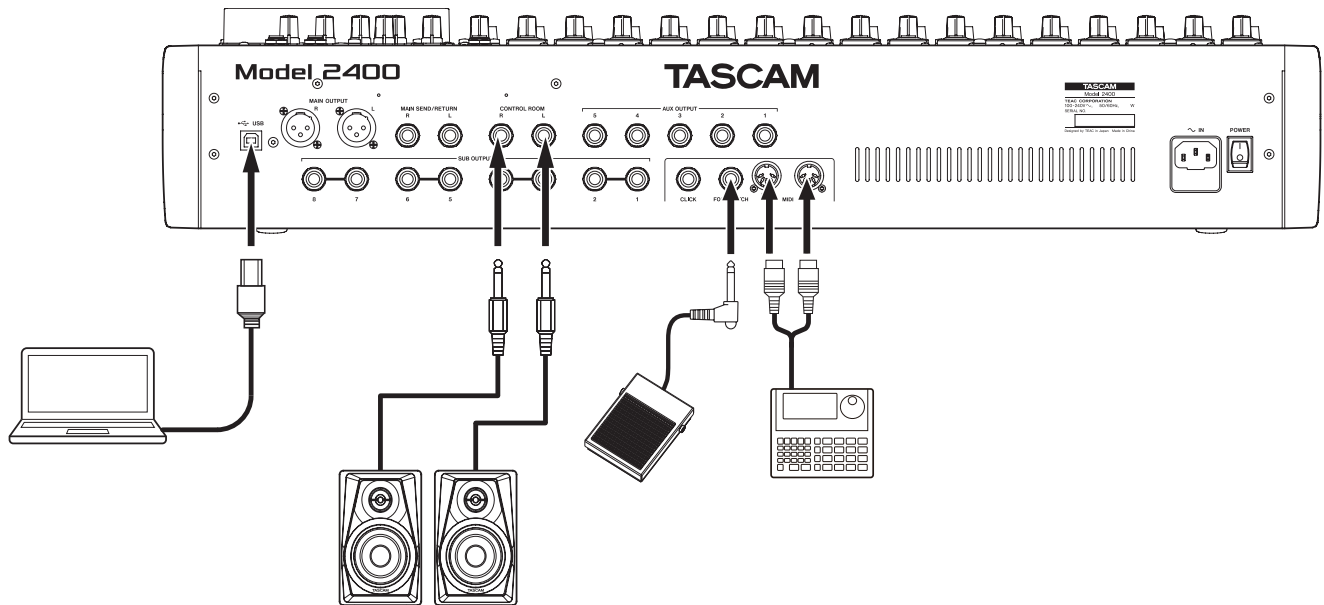

Examples of connections to a Model 2400

### Connecting microphones

#### Dynamic mics

Connect them to the MIC/LINE/INST and MIC/LINE input jacks on the top of the unit.

#### Condenser mics

When using a condenser microphone that requires phantom power, connect it to a MIC/LINE/INST or MIC/LINE input jack and then turn on the corresponding PHANTOM +48V switch. (see "Setting phantom power" on page 29.)

The PHANTOM +48V indicator lights when the PHANTOM +48V switch is on (pushed in).

### Connecting guitars, basses and similar instruments

When connecting a guitar, bass or other instrument with high impedance (Hi-Z) output directly to this unit, use a MIC/LINE/INST TRS jack (1–2) on the top of the unit and turn the INST switch on for that channel.

#### NOTE

- When connecting an instrument with active output or when the sound passes through an effects unit, for example, that is connected to this unit, the INST switch does not need to be set to on.
- When an INST switch is on, input through that MIC/LINE/INST TRS input jack will be unbalanced.

### Connecting electronic devices and other audio equipment

Use the following inputs to connect electronic devices and other audio equipment.

- MIC/LINE/INST input jacks (1–2) on the unit top
- MIC/LINE input jacks (3–12, 13/14–21/22) on the unit top

### Connecting monitor speakers

Connect monitor speakers (powered speakers or an amplifier and speaker system) to the CONTROL ROOM L/R jacks.

Depending on the PFL switch and AFL switch settings, signals from the MAIN MIX L/R bus and PFL/AFL L/R bus can be monitored.

Use the CONTROL ROOM knob to adjust the speaker volume.

### Connecting headphones

Connect headphones to the PHONES jack (standard stereo). The following signals can be monitored according to the PFL and AFL switch settings.

- Signals output from the MAIN OUTPUT connectors
- Signals output from the PFL/AFL L/R bus

#### CAUTION

Before connecting headphones, minimize the volume with the PHONES knob. Failure to do so could result in a sudden loud noise that could harm hearing, for example.

### Connecting a computer

Use a USB cable with a Type-B (USB 2.0) connector on one end and a connector that matches the computer USB port on the other end (USB-IF certification recommended) to connect the unit to a USB 2.0 port on the computer.

When the USB connection is working, the USB indicator in the screen operation section lights.

#### ATTENTION

The unit should be connected directly with the computer instead of via a USB hub. Moreover, noise could be picked up if the cable is too long.

## Connecting with iOS devices

To connect this unit with an iOS device that has a Lightning connector, use a Lightning to USB Camera Adapter\* with a USB cable.

To connect this unit with an iOS device that has a USB Type-C connector, use a USB cable.

\* You must obtain a genuine Apple Lightning to USB Camera Adapter separately.

## Connecting with Bluetooth devices

This unit can input sound from a computer, portable audio device or other equipment that supports Bluetooth (A2DP).

### Pairing

Follow the procedures below to enable communication with a Bluetooth device.

#### NOTE

Pairing also requires operation of the Bluetooth device. Refer to the operation manual of the Bluetooth device for procedures.

1. Set the ASSIGN switch to "21/22" or "MAIN".
2. Confirm that the PAIRING indicator on this unit is blinking. If it is unlit, press the PAIRING button.



#### NOTE

When the unit is turned on, it automatically becomes ready for pairing. If 2 minutes pass in pairing mode, it will end. Press this button to reactivate pairing mode when it is disabled.

3. Select "Model 2400" (this unit) on the other Bluetooth device. When pairing succeeds, the PAIRING indicator will stop blinking and remain lit, and connection with the other device will be complete.

#### NOTE

- Some older Bluetooth devices require the input of a passkey. Enter "0000" in such cases.
- Pairing will automatically end if connection is not confirmed within two minutes.
- When this unit is turned on, it will automatically try to connect with the Bluetooth device to which it was previously connected. At this time, pairing will automatically end after five minutes if connection is not possible because that Bluetooth device is not turned on or its Bluetooth function is turned off.

## Unpairing

The Bluetooth device that is currently connected can be unpaired from the unit.

1. Press and hold the PAIRING button for at least two seconds.
2. This ends the pairing. The PAIRING indicator will start blinking and the unit will be ready to pair.

## Inserting and removing SD cards

### Inserting SD cards

Insert an SD card into the SD card slot on the top of the unit to enable playback and recording by this unit.

#### NOTE

SD cards can be inserted whether or not the unit is on or off.

1. Open the SD card slot cover.
2. The SD card should be inserted with its label facing left.
3. Close the SD card slot cover.

### Removing SD cards

Turn the unit off or stop operation before removing an SD card.

#### CAUTION

Never remove an SD card when the unit is operating (including recording, playing back, or writing data to the SD card). Doing so could cause proper recording to fail, data to be lost, and sudden loud noises from monitoring equipment, which might damage the equipment, harm hearing or cause other trouble.

1. Press the SD card in gently to make it to come up.
2. Pull the SD card out.

### SD card write protection switches

SD cards have write-protection switches that prevent writing new data to them.

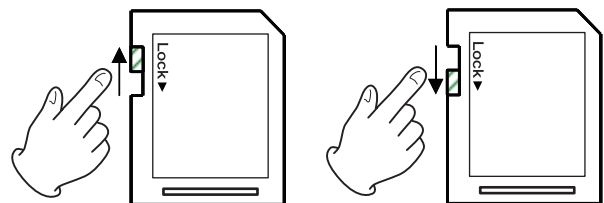

If you slide the write-protection switch to the "LOCK" position, writing will not be possible. Move the write-protection switch to the unlocked position in order to record, erase and otherwise edit data on the card.

## 3 - Preparation

### Turning the power on and off

#### ⚠ CAUTION

- Turn down the volume of the sound system connected to the unit before starting up or shutting down the unit.
- Do not wear connected headphones when turning the unit on and off. Loud noises could damage the speakers or harm your hearing.

#### Before turning the power on

1. Make the following settings on the top of the unit.
  - Output-related knobs → all the way left
  - Faders → all the way down
  - Switches → off (not pushed in)
2. Minimize the output levels of audio sources and input levels of amplifiers connected to this unit.

#### Turning the power on

1. Use the POWER switch on the back of the unit to turn its power on.



Startup screen

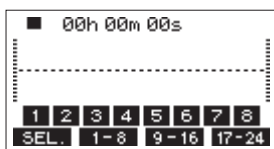

Meter Screen

After the unit starts and the Startup Screen is shown, the Meter Screen will open.

#### NOTE

- Press the MENU button to open the Home Screen.
  - After the unit is turned on, the PAIRING indicator will blink for a set amount of time.
2. Turn connected input audio source devices on.
  3. Finally turn amplifiers on.

### Turning the power off

Before turning the power off, minimize the levels of output faders and knobs, and then follow the procedures for turning on the power in reverse.

Failure to follow the correct order could result in clicking noises, for example, that might damage equipment.

#### ⚠ CAUTION

Do not turn off the power when the unit is operating (including recording, playing back, or writing data to an SD card). Doing so could cause proper recording to fail, recorded data to be lost, and sudden loud noises from monitoring equipment, which might damage the equipment, harm hearing or cause other trouble.

#### NOTE

When the unit is started up for the first time (or when the built-in clock is reset after being left unused without power for a long time), the DATE/TIME Screen will appear before the Startup Screen to allow the date and time of the built-in clock to be set. (see "Setting the built-in clock date and time" on page 22.)

### Setting the built-in clock date and time

Using its internal clock, this unit includes the date and time when a file is recorded.

1. When the recorder is stopped, select DATE/TIME on the SYSTEM Screen, and open the DATE/TIME Screen. (see "Menu operation procedures" on page 18.)

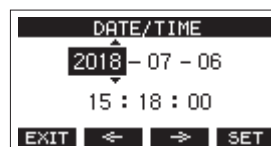

2. Turn the MULTI JOG dial to change a value, and press the MULTI JOG dial to confirm it and move the cursor to the next item.

#### NOTE

Use the F2 ◀ and F3 ▶ buttons to move the cursor.

3. Change the year, month, day, hour and minute in order, and complete the date and time setting.
4. Press the F4 EXIT button to confirm the setting and return to the SYSTEM Screen.

#### NOTE

- When making a setting, you can press the F1 EXIT button to cancel the changes and return to the SYSTEM Screen.
- When setting the time, the time display will be stopped.
- By setting the TYPE item to "DATE" on the SONG NAME Screen, the date and time set here can be used for song names. (see "Setting the song name format" on page 51.)

## Adjusting the display

The display contrast and brightness can be adjusted.

### Adjusting the display contrast

1. When the recorder is stopped, select DISPLAY on the SYSTEM Screen, and open the DISPLAY Screen. (see "Menu operation procedures" on page 18.)

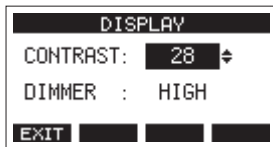

2. Adjust the display contrast.  
Options: 22 – 45 (default: 32)
3. Press the MULTI JOG dial to confirm the setting.
4. Press the **F1** **EXIT** button to return to the SYSTEM Screen.

### Adjusting the display brightness

1. When the recorder is stopped, select DISPLAY on the SYSTEM Screen, and open the DISPLAY Screen. (see "Menu operation procedures" on page 18.)
2. Press the MULTI JOG dial to move the cursor to the DIMMER item.

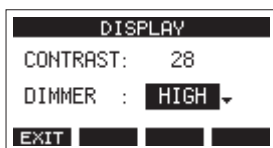

3. Adjust the display brightness.  
Options: HIGH (default), LOW
4. Press the MULTI JOG dial to confirm the setting.
5. Press the **F1** **EXIT** button to return to the SYSTEM Screen.

## Preparing an SD card for use

In order to make an SD card usable in this unit, whether for recording or playback, this unit must be used to create a system file on it first.

### ATTENTION

In order to record, this unit must be used to format it first. (see "Formatting SD cards" on page 52.)

### NOTE

When using external media (SD cards) with our products, we strongly recommend using media confirmed to work with them. Media that has not been confirmed to work with this product can be used, but unexpected problems could occur.

1. "No sys file. Make sys file. Are you sure?" appears in a pop up when a new card or a card formatted by another device is inserted into the unit.
2. Press the MULTI JOG dial to create a system file.  
When system file creation is complete, the Home Screen will reopen.

# 4 - Managing Songs

This recorder treats each recording data group as one song and manages data by song.

For one song, WAV files are saved for 22 tracks and a stereo master file.

These files are read-only format.

To record or produce music, a song that has already been created needs to be loaded or a new song needs to be created.

This chapter describes functions that range from basic operations such as procedures for loading songs and creating new songs to various song management functions.

## ATTENTION

Do not change names, delete or otherwise alter individual files inside the "MTR" folder. Doing so could prevent loading data as a song and make proper recording and playback operations impossible.

## NOTE

- The maximum recording time for a single song is 23:59:59.
- To use the WAV files from a song in a DAW or other application, copy them to a computer. Do not use the files on the SD card directly.

## Viewing the song list

To open a list of songs saved on an SD card, select SONG on the MENU Screen, and press the MULTI JOG dial to open the SONG Screen. (see "Menu operation procedures" on page 18.)

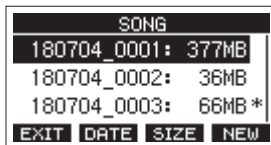

On the SONG Screen, the following functions are assigned to the function buttons.

- Press the **F1** **EXIT** button to return to the MENU Screen.
- Press the **F2** **DATE** button to show the date on the SONG Screen.
- Press the **F3** **SIZE** button to show the size on the SONG Screen.
- Press the **F4** **NEW** button to open the NEW Screen where you can create a new song. (see "Creating a New Song" on page 25.)

## Song Operation

Select the desired song file on the SONG Screen and press the MULTI JOG dial to open a pop-up menu list with possible song operations.

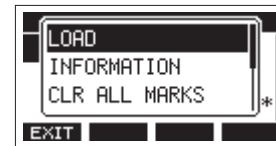

To use a song operation, turn the MULTI JOG dial to select the desired item, and press the MULTI JOG dial.

### LOAD/SAVE

Loads the selected song.

When the selected song is the current song, "SAVE" will appear and information about it will be saved.

### INFORMATION

View information about the selected song.

### CLR ALL MARKS

Clear all marks in the song.

### DELETE

Deletes the selected song.

### PROTECT

Protect the selected song.

### UNPROTECT

Stop protection of the selected song.

### RENAME

Edits the name of the selected song.



## Creating a New Song

To record or play with this unit, you must create and load a song. The following procedure can be used to create a new song.

1. Open the SONG Screen when the recorder is stopped. (see "Menu operation procedures" on page 18.)
2. Press the **F4** **NEW** button to open the NEW Screen.

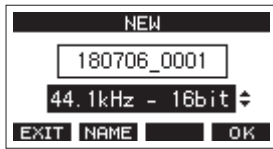

3. Turn the MULTI JOG dial to select the recording file format.  
Options: 44.1kHz - 16bit (default), 44.1kHz - 24bit, 48kHz - 16bit, 48kHz - 24bit
4. Edit the name of the song as necessary.  
To edit the name of the song, press the **F2** **NAME** button to open the NAME EDIT Screen.

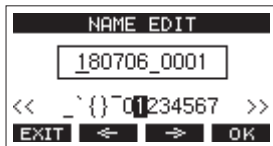

For details about how to edit song names, see "Editing text" on page 27.

### TIP

The song name can also be edited later using the RENAME Screen.

5. Press the **F4** **OK** button to save the currently loaded song and create a new song.  
When song creation completes, the SONG Screen reopens.

### NOTE



- To cancel song creation, press the **F1** **EXIT** button.
- A maximum of 100 songs can be created on a single SD card.
- Songs are created in the "MTR" folder on the SD card.
- When new songs are created, the tempo is set to 120 and the time signature is set to 4/4. (see "Making metronome settings" on page 43.)

## Loading Songs

Use the following procedure to load the song you want.

1. Open the SONG Screen when the recorder is stopped. (see "Menu operation procedures" on page 18.)

### NOTE

The  icon appears for a song currently being loaded. An  icon will appear before protected songs.

2. Select the song that you want to load and press the MULTI JOG dial to open the menu list pop-up.
3. Select LOAD, and press the MULTI JOG dial.  
After the selected song loads, the SONG Screen will reopen.

## Saving the current song

Song information, including marks added during playback of the current song as well as deleted marks, can be saved.

1. Open the SONG Screen when the recorder is stopped. (see "Menu operation procedures" on page 18.)
2. Select the current song, and press the MULTI JOG dial to open the menu list pop-up.

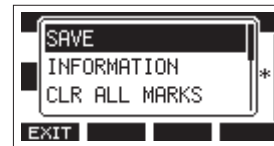

3. Select SAVE, and press the MULTI JOG dial.  
This saves the song information.

### ATTENTION

After saving, undoing or redoing the previous operation will no longer be possible.

## 4 - Managing Songs

### Viewing song information

You can check the song name (title), sampling frequency, bit rate, size, and date and time last written.

1. Open the SONG Screen when the recorder is stopped. (see "Menu operation procedures" on page 18.)
2. Select the song with information that you want to check and press the MULTI JOG dial to open the menu list pop-up.
3. Select INFORMATION, and press the MULTI JOG dial. The INFORMATION Screen will open.

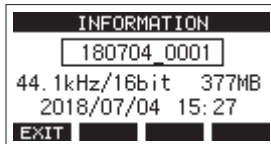

The song name, sampling frequency, bit rate, size, date and time last written will be shown.

4. After checking, press the **F1** **EXIT** button to return to the SONG Screen.

### Clearing all marks

This operation clears all marks added to the selected song.

1. Open the SONG Screen when the recorder is stopped. (see "Menu operation procedures" on page 18.)
2. Select the song with the marks that you want to delete and press the MULTI JOG dial to open the menu list pop-up.
3. Select CLR ALL MARKS, and press the MULTI JOG dial. The CLR ALL MARKS Screen will open.

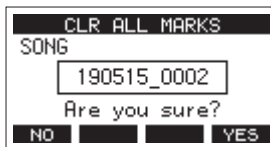

4. Press the **F4** **YES** button to confirm deletion of marks. When mark deletion completes, the SONG Screen reopens.

#### ATTENTION

Deleted marks cannot be restored.

### Deleting songs

You can delete songs.

Deleting unnecessary songs when the SD card space is low can create more open space.

1. Open the SONG Screen when the recorder is stopped. (see "Menu operation procedures" on page 18.)
2. Select the song that you want to delete and press the MULTI JOG dial to open the menu list pop-up.
3. Select DELETE, and press the MULTI JOG dial. The DELETE Screen will open.



4. Press the **F4** **YES** button to confirm deletion. When song deletion completes, the SONG Screen reopens.

#### ATTENTION

Deleted songs cannot be restored.

#### NOTE

- To cancel song deletion, press the **F1** **NO** button.
- The current song cannot be deleted. To delete the current song, load another song first.

## Protecting/unprotecting songs

By protecting a song, you can disable editing, recording and deletion operations for that song.

You can protect and stop protecting songs.

1. Open the SONG Screen when the recorder is stopped. (see "Menu operation procedures" on page 18.)
2. Select the song that you want to protect or unprotect and press the MULTI JOG dial to open the menu list pop-up.
3. Select PROTECT or UNPROTECT, and press the MULTI JOG dial.

The PROTECT or UNPROTECT screen will open.

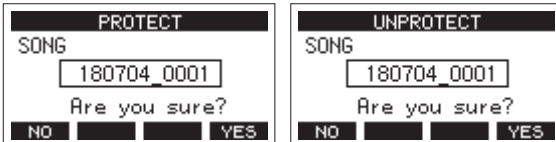

4. Press the **F4** **YES** button to protect or unprotect the song.

### NOTE

To cancel protection or unprotection, press the **F1** **NO** button.

5. When song protection or unprotection completes, the SONG Screen reopens.

### NOTE

- Lock icons appear before songs that are protected in the song list shown for copying, deletion and other operations.
- If you try to execute a prohibited operation (editing, recording, deletion) on a protected song, "Song is protected." will appear in a pop-up message on the display.

## Editing song names

1. Open the SONG Screen when the recorder is stopped. (see "Menu operation procedures" on page 18.)
2. Select the song with name that you want to change and press the MULTI JOG dial to open the menu list pop-up.
3. Select RENAME, and press the MULTI JOG dial. The RENAME Screen will open.

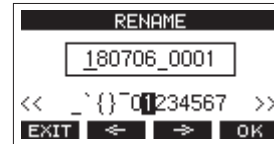

4. Edit the song name. For details about how to edit song names, see "Editing text" below.

### NOTE

To cancel song name editing, press the **F1** **EXIT** button.

5. When finished editing the song name, press the **F4** **OK** button to confirm the song name. When song name editing is complete, the SONG Screen reopens.

## Editing text

Use these operations to edit text.

### Changing the cursor (editing point) position:

Use the **F2** **←** and **F3** **→** buttons.

You can also press the MULTI JOG dial to move to the next character.

### Deleting the character at the cursor position:

Turn the MULTI JOG dial.

You can input up to 11 characters, including symbols, numbers, and uppercase and lowercase letters.

### Leaving a single space open:

Turn the MULTI JOG dial to select a blank space at the left end of any row, and press the MULTI JOG dial.

### Canceling edits:

Press the **F1** **EXIT** button.

### Confirming the changes:

Press the **F4** **OK** button.

## 4 - Managing Songs

### Loading songs created on different TASCAM Model series products

Songs created on TASCAM Model series products with different channel counts can be loaded on this unit.

Use the following procedure to load the song you want.

1. Open the SONG Screen when the recorder is stopped. (see "Menu operation procedures" on page 18.)

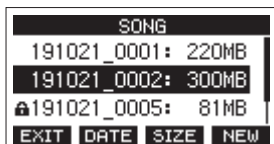

2. Select the song that you want to load and press the MULTI JOG dial to open the menu list pop-up. The name of the product used to create the song will be shown next to the LOAD item if it is different from this unit.

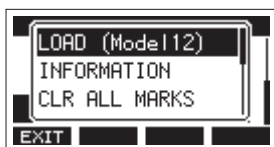

Loading a song made on a Model 12

#### NOTE

Songs made on a Model 24 have the same number of channels, so the model name will not be shown. This will be the same when loading a song made on this unit on a Model 24.

3. Select LOAD, and press the MULTI JOG dial. After the selected song loads, the SONG Screen will reopen.

### Loading a song from a unit with fewer channels on a unit with more channels

When loading a song from a unit with fewer channels on a unit with more channels, empty tracks will be created for the additional channels and the song will be converted for use with the model with more channels before loading.

Example: Loading a song from a Model 12 to a Model 2400

Source song	Song after loading
Tracks 1–10	Tracks 1–10 are loaded.
-	Empty tracks are created for tracks 11–22.
Track 11 (MAIN MIX L)	This is loaded as track 23 (MAIN MIX L).
Track 12 (MAIN MIX R)	This is loaded as track 24 (MAIN MIX R).

#### NOTE

- If the SD card is write-protected, the song will be loaded without conversion. See "SD card write protection switches" on page 21 for details about SD card write protection.
- If a song is protected, it will be loaded without conversion. It will automatically be converted if protection is disabled. See "Protecting/unprotecting songs" on page 27 for details about song protection.

### Loading a song from a unit with more channels on a unit with fewer channels

When loading a song from a unit with more channels on a unit with fewer channels, some tracks will not be available for recording and playback.

The unit will load tracks up to its number of channels from the song in order from the first.

MAIN MIX L/R tracks will be loaded as MAIN MIX L/R tracks.

The song will not be converted.

Example: Loading a song from a Model 2400 to a Model 12

Source song	Song after loading
Tracks 1–10	Tracks 1–10 are loaded.
Tracks 11–22	These are not loaded.
Track 23 (MAIN MIX L)	This is loaded as track 11 (MAIN MIX L).
Track 24 (MAIN MIX R)	This is loaded as track 12 (MAIN MIX R).

## Selecting the input source

This unit has 22 inputs (22 line/16 mic inputs) with XLR combo jacks and standard TRS jacks.

The MIC/LINE/INST TRS input jacks on channels 1–2 support high impedance input, including direct guitar input.

Turn the INST switch on (pushed in) when connecting an guitar or similar instrument directly.

### TIP

Set the INST switch to off, when connecting an electric-acoustic guitar with a built-in preamp or an active electric guitar, as well as when the signal passes through an effect device between the guitar and this unit.

## Setting the INPUT SEL switch

Using the INPUT SEL switch settings of each channel to select their input sources individually.

MIC/LINE:	Use the signal from the input jack as the input source.
USB:	Use a signal from a computer connected to the USB port as the input source.
MTR:	Use a playback signal from the SD card as an input source.

When a INPUT SEL switch is set to “MTR”, the signal from the input jack on that channel will be recorded.

This function is useful when recording and playing back repeatedly because the monitored sound is automatically switched according to the recording or playback status.

## Sounds on channels when in MTR mode

Transport status	REC button off	REC button on
Stop	Muted	Sound from input jack
Playing back	Playback sound only	Playback sound only + sound from input jack
Recording	Playback sound only	Sound from input jack

## Setting phantom power

When connecting a condenser mic that requires phantom power, press the corresponding PHANTOM +48V switch when the recorder is stopped to turn phantom power on/off.

When connecting a condenser mic that requires phantom power, press the corresponding PHANTOM +48V switch when the recorder is stopped to turn phantom power on/off.

### CAUTION

Set the following knobs and faders to their minimum values before changing the PHANTOM +48V switch on/off setting. Depending on the connected mics, sudden loud noises from monitoring equipment could occur, and this could damage the equipment or harm hearing.

- GAIN knobs
- Channel faders
- SUB fader
- AUX 1–4 and AUX 5/FX knobs
- MAIN fader
- CONTROL ROOM knob
- PHONES knob

### ATTENTION

- Before connecting condenser mics, turn this unit and all equipment to be connected off (standby).
- The PHANTOM +48V switch turns it on/off for the input channels (1–4, 5–8, 9/12–13/20) simultaneously. Do not turn the PHANTOM +48V switch on (pushed in) when connecting a mic that does not require phantom power.
- Do not connect or disconnect mics when the PHANTOM +48V switch is on (pushed in). Doing so could cause a loud noise and might damage this unit and connected equipment.
- Turn the PHANTOM +48V switch on (pushed in) only when using a condenser microphone that requires phantom power. Turning the PHANTOM +48V switch on (pushed in) when a dynamic mic or other mic that does not require it is connected could damage this unit and connected equipment.
- When using condenser mics that require phantom power and dynamic mics together, be sure to use balanced dynamic mics. Unbalanced dynamic mics cannot be used when phantom power is enabled.
- Supplying phantom power to some ribbon mics could break them. If you are unsure, do not supply phantom power to a ribbon mic.
- Do not turn on the power for this unit when a PHANTOM +48V switch is on. Doing so could cause problems with the operation of this unit and connected equipment.

## Monitoring

Monitoring is important when recording and mastering.

With this unit, monitoring is possible using an external monitoring system (powered monitor speakers or an amp and speakers) or using stereo headphones.

Use the CONTROL ROOM and PHONES knobs to adjust monitoring system levels.

# 5 - Basic recording

## SIG indicators and level meters

The channel 1–12, 13/14–21/22 SIG indicators and level meters shown on the Meter Screen can be used to check the levels of this unit's audio signals.

In addition to using the level meters to visually check signal levels, they can also be used to check whether signals are being input to this unit. For example, even if no sound is output from monitors, if the Meter Screen level meters are moving, signals are being input to this unit.

The SIG indicators light green when signals (of at least –18 dB) are input through their channels.

If a SIG indicator lights red, the input source signal is too loud or the GAIN knob is turned up too far.

If the SIG indicator lights red even when the GAIN knob is turned all the way to the left, the input source signal is too loud. Lower its volume.

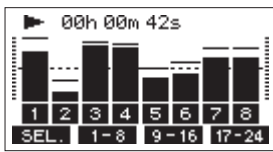

### Track level meters (1–12, 13/14–21/22)

The show track playback signal or track input signal levels. Channels for which the INPUT SEL switch is set to "MTR" will show the following signal levels according to the operation status.

REC button	Transport status	Level meter display
Unlit	PLAY	Track playback signal
Blinking (recording standby)	PLAY	Playback signal Track input + playback signal
	Stop	Track input signal
Blinking (recording)	Record	Track input signal

#### NOTE

When the playback signal is shown, the level of the recorded signal on the track is being shown, so the levels of the level meters cannot be changed.

When the input signal is shown, adjusting channel 1–12, 13/14–21/22 GAIN knobs will change the levels of the level meters.

#### TIP

Please see "Meter Screen details" on page 16 for details about the Meter Screen.

### MAIN MIX L/R level meters (MAIN)

These show the MAIN MIX L/R bus levels.

## Recording

This unit can simultaneously record up to 24 tracks, including 22 channel inputs and the MAIN MIX L/R bus.

The following recording operations assume that mics, guitars and other things to record have been connected to the unit, input signals have been assigned as track recording sources, monitoring equipment has been connected and a song has been loaded.

1. Press the REC buttons for channel to record. Press the REC button to start recording standby. It will blink red. When a INPUT SEL switch is set to "MTR", the signal from the input jack on that channel will be recorded. (see "Setting the INPUT SEL switch" on page 29.)

#### NOTE

- The MAIN MIX L/R bus does not have a REC button, but it is always in recording standby. The signals of the MAIN MIX L/R bus will always be recorded if the ● button is pressed.
- The MAIN MIX L/R bus signals are recorded as channel 23/24 tracks on the SD card.
- When the REC buttons of tracks that already have recordings is blinking, press them to make them unlit.

2. Set the recording levels. Use the GAIN knobs of each channel to adjust their input levels. Watch the SIG indicators above and to the right of the GAIN knobs, and set the levels suitably. At the same time, check that the sound heard through headphones or a monitoring system is not distorted and that an unintended effect has not been set.

#### NOTE

If an input is too loud, the SIG indicator will light red. If the SIG indicator lights red even when its GAIN knob is turned all the way to the left, lower the volume of the input source.

3. Press the ● button. Recording will start and the ● and ►/|| buttons will light. The REC buttons for tracks to record will stop blinking and stay lit.
4. When recording has completed, press the ■ button.
5. Use the ◀◀/▶▶ buttons and ■ button, for example to locate to a position you want to check.

#### TIP

For details about the locate function, see "Locate function" on page 34.

6. Press the ►/|| button to play the recorded tracks. Use the channel and MAIN faders to adjust the playback levels. Use the volume of the monitoring system to adjust the final monitoring level. Use the PAN knobs of each channel to set the position of each track signal between left and right speakers.

#### NOTE

- The channel PAN knobs and channel faders control the playback output signals of already recorded tracks or the monitoring volume of input signals. They do not control signals to be recorded.
- If you are not satisfied with a recording, repeat the above procedure from the beginning.

## Undoing operations

If you make a mistake operating the unit or want to do a recording over, for example, the operation last conducted can be undone. Editing, recording and other operations can be undone. The following types of operations can be undone.

- Recording operations
- Auto punch in/out operations
- Track clearing operations
- Normalization operations

If a song is loaded or the unit is turned off, information used for undoing and redoing will be lost, so undoing and redoing previous operations will no longer be possible.

### NOTE

Files used for undoing are temporarily saved on the SD card. If you want to delete those files to make more space on the SD card, reload the current song on the SONG Screen.

## Undoing the previous operation

1. When the Home Screen is open, press the **F3 UNDO** button.



The following confirmation pop-up message will appear.



2. Press the **F4 YES** button to return to the state before the previous operation.

### NOTE

To cancel undoing, press the **F1 NO** button.

## Redoing an undone operation

1. After undoing, when the "REDO" appears on the Home Screen, press the **F3 REDO** button. The following confirmation pop-up message will appear.



2. Press the **F4 YES** button to restore the previous operation and return to the state before undoing.

### NOTE

To cancel redoing, press the **F1 NO** button.

## Using the built-in effects

This unit has built in effects, so you can apply effects without an external effect device.

Channels 1–12 and 13/14–21/22 can have an effect applied. Their signals are sent to the built-in effect by the AUX 5/FX bus. The return signal is sent to the following buses.

- MAIN MIX L/R bus
- PFL/AFL L/R bus
- AUX 1–4 buses
- SUB buses (SUB 1–2, 3–4, 5–6, 7–8)

### ATTENTION

When AUX OUTPUT 5 jacks are in use, the built-in effect processor cannot be used.

1. Use the AUX 5/FX knobs of each channel to adjust the levels of signals sent to the AUX 5/FX bus.
2. Use the EFFECT Screen to select the type of effect. (see "Setting the built-in effect" on page 31.)
3. Use the FX fader, bus send switches and knobs to adjust the return levels for each bus.

## Setting the built-in effect

1. Press the SELECT button to open the EFFECT Screen.

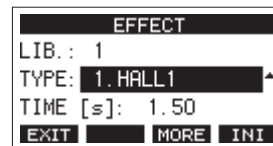

2. Turn the MULTI JOG dial, and set the built in effect type.

Option	
1.HALL1 (default)	2.HALL2
3.ROOM1	4.ROOM2
5.PLATE	6.STUDIO
7.LIVE	8.DELAY1
9.DELAY2	10.PING PONG
11.CHORUS	12.FLANGER
13.DELAY+HALL1	14.DELAY+HALL2
15.CHORUS+HALL1	16.CHORUS+HALL2

3. Press the MULTI JOG dial to select the PARAMETER item. The parameter item is dependent on the selected effect.

## 5 - Basic recording

- Turn the MULTI JOG, and adjust the set effect.  
You can check the effect as you change it.



### NOTE

- Turn the MULTI JOG dial to change the **F4** button function from **INI** to **UNDO**. Press the **F4 UNDO** button to return to the state before turning the MULTI JOG dial.
- Press the **F4 INI** button to set a parameter value to its default.
- "**TAP**" appears for effects that include delay. When the TIME parameter item is selected, the CLICK button can be pressed repeatedly at the desired speed to set the tempo.

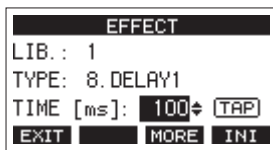

- When the footswitch setting is "TAP", the footswitch can be used instead of the CLICK button for TAP delay input. (see "Setting up the footswitch" on page 47.)
- Press the **F1 EXIT** button to return to the Home Screen.

## Using the library

This unit has a library function that allows up to 10 built-in effect settings to be saved.

### Saving effects settings in the library

- Press the SELECT button to open the EFFECT Screen.
- Press the MULTI JOG dial to select the LIB item.

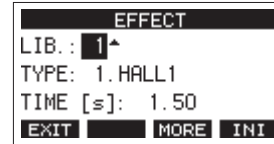

- Turn the MULTI JOG dial to select the library number to save.
- Follow the procedures in "Setting the built-in effect" to set the built-in effect.  
This saves the effect setting in the library.

### Using an effect setting saved in the library

- Press the SELECT button to open the EFFECT Screen.
- Press the MULTI JOG dial to select the LIB item.
- Turn the MULTI JOG dial to select the library number with the saved effect setting you want to use.  
This applies the saved effect setting.



## Making additional effect adjustments

When the EFFECT Screen is open, press the **F3 MORE** button to open an additional settings screen where parameters for each effect can be adjusted more precisely.

The parameters that can be adjusted for each effect on the additional settings screen are as follows.

### NOTE

- When the MULTI JOG dial is turned, the **F4** button will become the **UNDO** button. Press the **F4 UNDO** button to return to the state before turning the MULTI JOG dial.
- After undoing, the **F4** button will become the **REDO** button. Press the **F4 REDO** button to return to the state before undoing.
- While the SHIFT button is pressed, the **F4** button becomes the **INI** button. Press the **F4 INI** button to set a parameter value to its default.

### 1. HALL 1, 2. HALL 2, 3. ROOM 1, 4. ROOM 2, 5. PLATE, 6. STUDIO, 7. LIVE

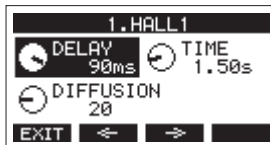

Parameter name	Range
DELAY	0 – 99 ms
TIME	0.10 – 10.00 s
DIFFUSION	0 – 99

### 8. DELAY 1, 9. DELAY 2, 10. PING PONG

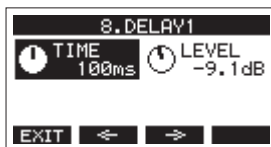

Parameter name	Range
TIME	1 – 1000 ms
LEVEL	-INF – -2.2 dB

### 11. CHORUS

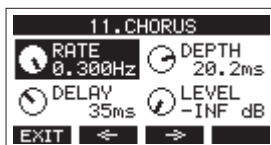

Parameter name	Range
RATE	0.100 – 0.300 ms
DEPTH	5.5 – 33.0 ms
DELAY	0 – 99 ms
LEVEL	-INF – -10.1 ms

### 12. FLANGER

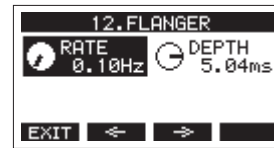

Parameter name	Range
RATE	0.10 – 5.00 Hz
DEPTH	1.00 – 8.00 ms

### 13. DELAY+HALL 1, 14. DELAY+HALL 2

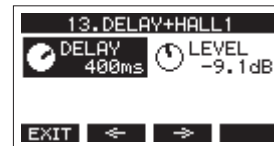

Parameter name	Range
DELAY	1 – 1000 ms
LEVEL	-INF – -2.2 dB

### 15. CHORUS+HALL 1, 16. CHORUS+HALL 2

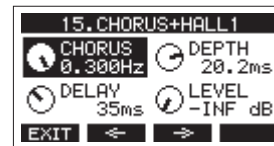

Parameter name	Range
CHORUS	0.100 – 0.300 ms
DEPTH	5.5 – 33.0 ms
DELAY	0 – 99 ms
LEVEL	-INF – -10.1 ms

# 6 - Recorder functions

## Locate function

When the Home Screen is open, you can use the MULTI JOG dial to set the locate point.

On the Home Screen, the current position of the recorder is shown as a time in hours (h), minutes (m) and seconds (s).

By setting the time in this display area, you can change the current position of the recorder.

## Changing the playback position

When the Home Screen is open and the recorder is stopped or playing back, you can use the MULTI JOG dial to set the locate point.

## Using the direct locate function to locate

1. When the Home Screen is open and the recorder is stopped, press the MULTI JOG dial to enable direct locate mode. A cursor will appear at the location to be changed in the recorder counter.

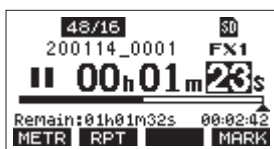

2. Turn the MULTI JOG dial to change a value, and press the MULTI JOG dial to confirm it and move the cursor to the next item.
3. Change the seconds, minutes and hours in that order to move to that time as the current recorder position.
4. Press the ►/|| button to start playback or the ● button to start recording from that position.

## Repeat playback function

The repeat playback function can be used to play something over and over.

When the Home Screen is open, press the **F2 RPT** button to set the repeat playback function.

Nothing shown: The current song will keep playing regardless of whether the area is recorded or not.

**S1**: The current song will play and then stop.

**↻1**: The current song will play repeatedly.

## Punch in/out function

Punching in and out is a technique used to replace parts of already recorded tracks.

You can start playback of a recording, switch to recording when it reaches the part to be replaced (punch in), and then switch back to playback when the end of that part is reached (punch out) and stop after two seconds.

1. Determine the part you want to replace in advance. Select a point where the replacement audio can be combined well with the original track audio.

2. Press the REC button for the track with the part to be replaced to enter recording standby (REC button blinks).

### NOTE

- Set the punch in and out points at least one second apart.
  - Punching in can be used simultaneously with a maximum of 8 tracks. Press REC buttons to reduce the number of recording tracks to 8 or less.
3. Start playback before the part to be replaced.
  4. When the part to be replaced is reached, press the ● button, and perform the part. Recording will start (punch in).
  5. When the end of the part to be replaced is reached, press the ■ button. The unit will switch to playback and then stop after two seconds.

## Using the footswitch to punch in/out

A footswitch can be used to punch in/out if the recommended TASCAM RC-1F footswitch (sold separately) is connected to the FOOTSWITCH jack on the rear panel.

To use a footswitch to punch in/out, you must set the foot switch function assignment to "PUNCH I/O" in advance. (see "Setting up the footswitch" on page 47.)

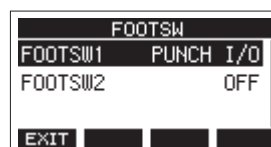

At step 4 above, press the footswitch instead of the ● button, and at step 5 press it again instead of the ■ button.

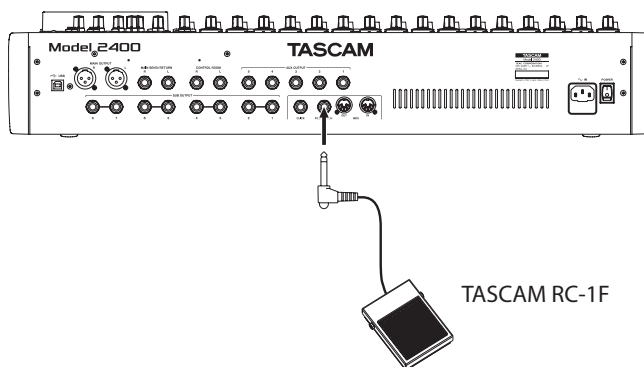

### NOTE

This unit was designed to be used with unlatched (momentary) footswitches that have to be pushed to function (shorted when pushed).

## Automatic punch in/out function

Using the automatic punch in/out function, you can automatically record between punch in and out points set in advance.

To use the automatic punch in/out functions, start playback from a pre-roll point before the punch in point where recording will start.

Recording will stop when the punch out point is reached, but playback will continue for two seconds before stopping.

## Setting the punch in/out points

1. When the recorder is stopped, select MTR on the MENU Screen, and open the MTR Screen. (see "Menu operation procedures" on page 18.)
2. Select AUTO PUNCH on the MTR Screen, and open the AUTO PUNCH Screen.

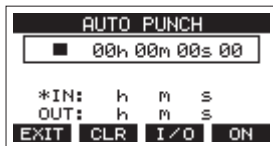

3. Press the ►/|| button to start playback.
4. Press the MULTI JOG dial to set the punch in and out points. The set points are shown next to the IN and OUT items.

### NOTE

- You can also turn the MULTI JOG dial to set the points.
  - Set the punch in and out points at least one second apart.
  - Press the **F2 CLR** button to clear set punch in and out points.
  - Press the **F3 I/O** button to select either the punch in or out point. An ✚ icon will appear next to the selected item.
5. Press the ■ button to stop playback.
  6. Press the **F4 ON** button to turn the automatic punch in/out function on. The **A.PUNCH** icon appears on the AUTO PUNCH Screen.

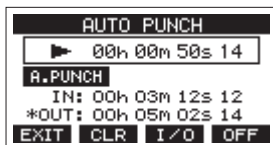

7. Press the **F1 EXIT** button to return to the MENU Screen.

### TIP

- By setting only the punch in point, you can start recording with automatic punch in and then continue recording until you press the ■ button to stop.
- By setting only the punch out point, you can start recording by pressing the ● button and then stop recording with automatic punch out.

## Setting a pre roll point

When using automatic punch in, the amount of playback time before the punch in point can be set (pre roll point).

1. When the recorder is stopped, select MTR on the MENU Screen, and open the MTR Screen. (see "Menu operation procedures" on page 18.)
2. Select A.PUNCH PRE ROLL on the MTR screen to open the A.PUNCH PRE ROLL screen.

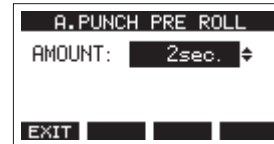

3. Set the pre-roll point.

Option	Meaning
OFF	Do not locate to a point before the punch in point. Manually moving to somewhere before the punch in point beforehand will be necessary.
1sec. – 10sec. (default: 2sec.)	Locate to a pre roll point the set time before the punch in point and start playback.

4. Press the **F1 EXIT** button to return to the MTR Screen.

## Rehearsing punching in and out

You can rehearse before punch in/out recording. In rehearsal, recording will not occur, but monitoring will be the same as if recording.

1. Press the MENU button when the recorder is stopped to open the Home Screen. Confirm that the **A.PUNCH** icon appears on the Home Screen.

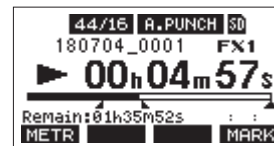

2. Press the REC buttons for the tracks you want to record using automatic punch in/out.

### NOTE

Punching in can be used simultaneously with a maximum of 8 tracks. Press REC buttons to reduce the number of recording tracks to 8 or less.

3. Press the ►/|| button. Auto punch in/out rehearsal starts.
  - The transport starts playback from the pre-roll point. Both track playback and input source signals can be monitored. (see "Setting a pre roll point" on page 35.)
  - When the punch in point is reached, only input source signals will be monitored. The ● button will blink, showing that rehearsal mode is active.
  - When the punch out point is reached, both track playback and input source signals will be monitored. The ● button will become unlit.
  - Playback will automatically stop two seconds after the punch out point. The ►/|| button will blink. Rehearsal can be repeated.

## 6 - Recorder functions

### Using automatic punching in and out

Follow these procedures to punch in and out automatically and record.

1. Confirm that the **A.PUNCH** icon appears on the Home Screen.
2. Press the REC buttons for the tracks you want to record using automatic punch in/out.

#### NOTE

Punching in can be used simultaneously with a maximum of 8 tracks. Press REC buttons to reduce the number of recording tracks to 8 or less.

3. Press the ● button.
  - The transport starts playback from the pre-roll point. Both track playback and input source signals can be monitored. (see "Setting a pre roll point" on page 35.)
  - When the punch in point is reached, only the input source signal will be monitored. The ● button will light.
  - When the punch out point is reached, both track playback and input source signals will be monitored. The ● button will become unlit.
  - Playback will automatically stop two seconds after the punch out point. The ► / || button will blink.

## Clearing tracks

The selected track will be cleared.

1. When the recorder is stopped, select MTR on the MENU Screen, and open the MTR Screen. (see "Menu operation procedures" on page 18.)

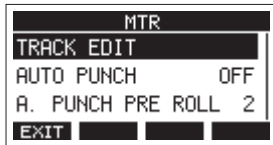

2. Select TRACK EDIT on the MTR Screen, and open the TRACK EDIT Screen.



3. Select TRACK CLEAR on the TRACK EDIT Screen, and open the TRACK CLEAR Screen.

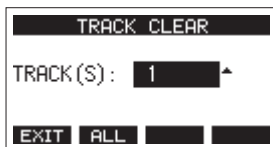

4. Turn the MULTI JOG dial to select the track to clear, and press the MULTI JOG dial. A confirmation message will appear.

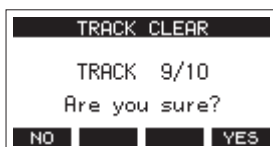

### NOTE

Press the **F2** **ALL** button to open a message asking to confirm that you want to clear all tracks.



5. Press the **F4** **YES** button to clear the track(s). After clearing tracks completes, the TRACK CLEAR Screen will reopen.

### NOTE

- To cancel clearing tracks, press the **F1** **NO** button.
- Undoing is possible only for the last cleared track.

## Importing tracks

You can import audio files that you have to tracks in the current song.

Files that can be imported to tracks must be WAV (BWF) format (".WAV" extension).

To import an audio file with a different format (.mp3, etc.) to this unit, it must be converted to a WAV file that matches the format of the song it will be imported into beforehand.

1. Connect this unit with a computer. (see "Connecting with a Computer" on page 54.)
2. Use the computer to copy WAV files on it to this unit's "MUSIC" folder.
3. Follow the proper disconnection procedures on the computer before disconnecting the USB cable. (see "Disconnecting" on page 54.)
4. When the recorder is stopped, select MTR on the MENU Screen, and open the MTR Screen. (see "Menu operation procedures" on page 18.)
5. Select TRACK EDIT on the MTR Screen, and open the TRACK EDIT Screen.
6. Select IMPORT on the TRACK EDIT Screen, and open the TRACK IMPORT Screen.  
WAV files in the "MUSIC" folder will be shown.

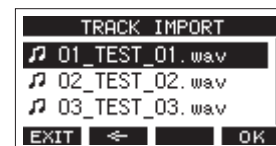

7. Select a WAV file to import.
  - Turn the MULTI JOG dial to select a WAV file.
  - Press the MULTI JOG dial when a folder is selected to show its contents.
  - Press the **F1** **EXIT** button to return to the MENU Screen.
  - Press the **F2** **←** button to move up one level.

# 7 - Track editing

8. Press the **F4** **OK** button.  
A confirmation message will appear if the bit length of the WAV file to be imported differs from the current song.



Confirmation message example

- Press the **F1** **NO** button to return to the TRACK IMPORT screen.
- Press the **F4** **YES** button to continue to the TRACK IMPORT screen. In this case, the file will be imported and the bit length will be changed to match the current song.

### NOTE

- If there are no openings for tracks to import, an "Import error. No track" pop-up message will appear.
  - To cancel importing a track, press the **F1** **NO** button.
  - Importing is not possible under the following conditions.
    - Not enough open space is available on the SD card
    - There are no empty tracks
    - If the sampling frequency of the WAV file you are trying to import differs from the current song  
Example: Trying to import a 48 kHz WAV file when the current song is 44.1 kHz
  - If there is no file that can be imported, a "No File" pop-up message will appear.
9. Select the track to import, and press the **F4** **YES** button to import it.

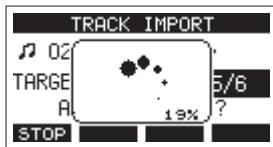

When importing completes, the TRACK IMPORT Screen reopens.

### NOTE

- Press the **F1** **STOP** button to cancel importing.
- The part of the track imported before canceling will remain; it will not be deleted.

## Swapping tracks

Recorded tracks can be swapped with other tracks.

1. When the recorder is stopped, select MTR on the MENU Screen, and open the MTR Screen. (see "Menu operation procedures" on page 18.)
2. Select TRACK EDIT on the MTR Screen, and open the TRACK EDIT Screen.
3. Select TRACK SWAP on the TRACK EDIT Screen, and open the TRACK SWAP Screen.



4. Turn the MULTI JOG dial to select the source track to be swapped.
5. Press the MULTI JOG dial to move the cursor to the B item.
6. Turn the MULTI JOG dial to select the destination track to be swapped.
7. Press the **F4** **YES** button to swap the track specified in the A and B items.

### NOTE

This can be used as a basic bounce function by swapping the signals recorded on the MAIN tracks (the output from the MAIN OUTPUT connectors) to other tracks, and then clearing other tracks.

## Normalization function

By using the normalization function, the maximum levels of tracks recorded by the MTR can be readjusted within a range of 0 to -20 dB.

Adjusting level differences between tracks makes mixing down easier. Imported tracks and MAIN MIX L/R bus recording files can also be normalized.

## Using the normalization function

1. When the recorder is stopped, select MTR on the MENU Screen, and open the MTR Screen. (see "Menu operation procedures" on page 18.)
2. Select TRACK EDIT on the MTR Screen, and open the TRACK EDIT Screen.
3. On the TRACK EDIT Screen, select NORMALIZE and open the NORMALIZE Screen.



4. Turn the MULTI JOG dial to select a track to normalize.

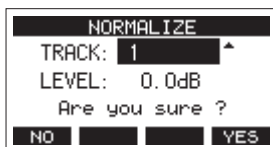

5. Turn the MULTI JOG dial to select the normalization level.  
Options: 0 – -20 dB (default: 0 dB)

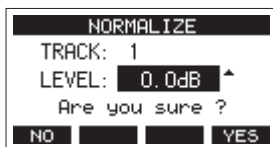

6. Press the **F4 YES** button to normalize the specified track.

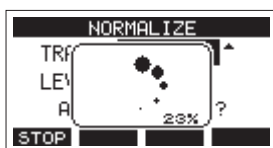

- During conversion, press the **F1 STOP** button to cancel processing. Normalization will not be conducted if canceled.

A "Process done" message will appear after it completes.

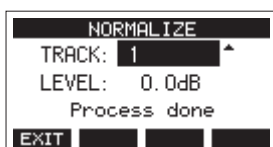

7. Turning the MULTI JOG dial to change the track or level will restore the screen to its state in step 4.  
To continue normalizing other tracks, repeat the procedures from step 4.

## Reversing normalization

Tracks that have been normalized can be restored to their previous state by using the undo function. Moreover, after undoing to reverse normalization, the redo function can be used to restore it.

### NOTE

If a song is loaded or the unit is turned off, information necessary for undoing and redoing will be lost, so undoing and redoing previous operations will no longer be possible.

- After normalizing, if the **F3 UNDO** function button shows **UNDO** on the Home Screen, the previous normalization operation can be reversed.  
If normalization was canceled or the maximum volume of the track before normalization was the same as the normalized level, the **UNDO** button will not be shown.

1. To undo the operation, press the **F3 UNDO** button.



The following confirmation pop-up message will appear.

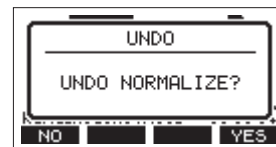

2. Press the **F4 YES** button to restore the track to the volume it had before normalization.

- After undoing, if the **F3 REDO** function button shows on the Home Screen, the previous undo operation can be reversed.

1. To redo the operation, press the **F3 REDO** button.



The following confirmation pop-up message will appear.

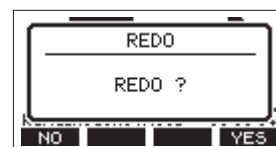

2. Press the **F4 YES** button to restore the result of normalization that was undone, reverting to the normalized track volume.

# 7 - Track editing

## Mixing down

A mixdown is when the volume, panning and other settings of individual track recordings are adjusted and combined into a well-balanced stereo mix.

The MAIN MIX L/R bus does not have a REC button, but it is always in recording standby. Pressing the **●** button always records the signals on this bus. The MAIN MIX L/R bus signals are recorded as channel 23/24 tracks on the SD card.

Stereo mix files can be created after recording by readjusting as desired the balance of the tracks recorded on each channel and mixing them down.

1. Adjust the recorded sound and play it back.
  - Set the INPUT SEL switches of the recorded tracks to "MTR".
  - Turn on the MAIN switches of the recorded tracks. (Turn off the MAIN switches of unrecorded tracks.)
  - While using speakers or headphones, for example, to listen to the sounds of all the recorded tracks being output from the MAIN OUTPUT jacks, adjust the channel faders and EQ and PAN knobs.

After confirming, stop playback and return to the beginning of the song.

2. Mix down the playback sound.
  - With the REC buttons off (unlit) on each channel, press the **●** button to create a stereo mix from the playback sounds of all the recorded tracks.
  - During mixdown, all fader and EQ and PAN knob adjustments will be recorded from the time that the **●** button is pressed and track playback is started until the **■** button is pressed to stop playback. This will overwrite the existing stereo file.

## Stereo mix export function

MAIN MIX L/R bus recording files (mono) can be converted to a single stereo file.

Converted stereo files are saved in the "MUSIC" folder.

Saved files are named according to the song name. For example, the file name will be "181228\_0002\_2-MIX\_01.wav" if the song name is "181228\_0002".

If the size of the converted file would exceed 2 GB, multiple files will be created with numbers like "02" and "03" at their ends.

1. Load the song to be exported as a stereo mix in advance. For details about loading songs, see "Loading Songs" on page 25.
2. When the recorder is stopped, select STEREO MIX EXPORT on the MENU Screen, and open the STEREO MIX EXPORT Screen. (see "Menu operation procedures" on page 18.)



3. Press the **F4** **YES** button to start conversion.

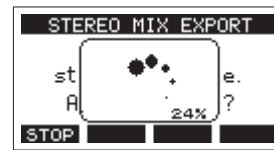

### NOTE

- If a converted file already exists, a message to confirm overriding appears.

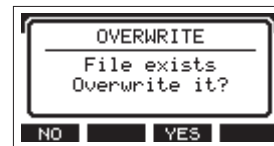

Press the **F3** **YES** button to delete the existing file and start conversion. This operation cannot be undone.

- Conversion is not possible if no MAIN MIX L/R bus file has been recorded. The message shown below will appear.



- During conversion, press the **F1** **STOP** button to cancel conversion. A file with the part converted before canceling will remain.

4. When conversion completes, the MENU Screen will reopen.

### NOTE

Converted files can be played using this unit's SD PLAY mode. For details about playback with the SD PLAY mode, see "Playing WAV files on SD cards (SD PLAY mode)" on page 53.



# 8 - Mark functions

Marks can be used to cue for playback, for example. In addition to use with this unit, mark information added to WAV files can be used with software, for example, that supports the BWF format.

## Adding marks

When playing or recording, press the **F4 MARK** button to add a mark at the current point.

When a mark is added, a pull-up showing the mark number appears at the bottom of the display.

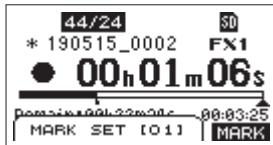

Mark ■ icons appear below the playback position bar where marks are set.

- The [ xx ] in the mark name is a number given to all marks that is incremented in order.
- Marks added during recording will automatically be saved in the song when recording stops.
- Marks added during playback will not be automatically saved. Save song information after stopping playback to save mark data. (see "Saving the current song" on page 25.)

### NOTE

If an ✱ icon appears at the beginning of a song name, it has unsaved mark data. Save the song information to save the mark data. (see "Saving the current song" on page 25.)

## Moving between marks

When stopped, paused or playing back, press the ◀◀ or ▶▶ button to move (skip) to the previous or next mark.

When skipping, the mark name appears in a pull-up at the bottom of the display.

## Clearing individual marks

Marks can be cleared when stopped or paused.

1. Skip to a mark that you want to delete when stopped or paused. (see "Moving between marks" on page 41.)
2. Press the **F4 MARK** button to open the Mark Clear confirmation screen.



3. Press the **F4 YES** button to clear the mark.

### NOTE

- Repeat steps **1 – 3** to clear multiple marks.
- To clear all marks in the current song, select the CLR ALL MARKS item from the menu list shown on the SONG Screen. (see "Clearing all marks" on page 26.)

# 9 - Other functions

## Metronome functions

This unit has a built-in metronome. Click sound and metronome settings can be made.

### NOTE

Metronome function settings are saved in the current song. The settings saved in the song can be used the next time it is loaded.

## Setting the click sound

The output can be set for the metronome click sound. The setting procedures differ according to the output destination.

## Setting the click sound output from the CLICK jack

1. When the recorder is stopped, select SETTING on the CLICK Screen, and open the CLICK SETTING Screen. (see "Menu operation procedures" on page 18.)

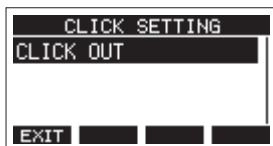

2. On the CLICK SETTING Screen, select CLICK OUT, and open the CLICK OUT Screen.

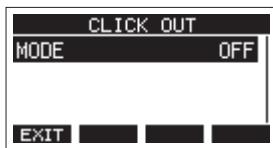

3. Select MODE on the CLICK OUT Screen, and open the MODE Screen.

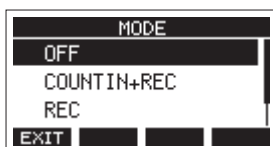

4. Turn the MULTI JOG dial to select the click sound output mode.

Option	Meaning
OFF (default)	Click is not output with recording or playback
COUNT IN+REC	Click is output during count in and recording
REC	Click is output during recording
REC&PLAY	Click is output during recording and playback

5. Press the MULTI JOG dial to confirm the setting. The CLICK OUT Screen reopens.

6. Press the MULTI JOG dial to confirm the setting. The CLICK OUT Screen reopens. Starting recording or playback will cause the click to be output according to the setting. When the setting is enabled, the TEMPO indicator flashes in time with the metronome tempo. The metronome signal is not recorded even if set to work during recording.

### NOTE

- When the metronome is working, you can monitor the sound of the metronome through connected external speakers. Note, however, in this case that the metronome sound could also be recorded if you are using a microphone to record in the same room.
- You can use the metronome as a click track to help keep time when recording rhythm guitar or bass, for example, as the first tracks of a song.
- If you want to use the metronome alone for practice, you can either turn each track's fader all the way down during playback or play a song that does not have any recordings.

## Making metronome settings

Specific metronome settings can be made.

1. When the recorder is stopped, select **CLICK** on the **MENU** Screen, and open the **CLICK** Screen. (see "Menu operation procedures" on page 18.)
2. Select **METRONOME** on the **CLICK** Screen, and open the **METRONOME** Screen.

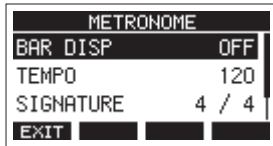

3. Turn the **MULTI JOG** dial to select a metronome setting item. Then, press the **MULTI JOG** dial. The corresponding setting item screen will open.

### BAR DISP

This sets the display of the time counter on the Home Screen.

Options: OFF (default), ON



When ON, the time counter on the Home Screen switches to bars and beats, showing the tempo and time signature in the **B** area.

The maximum number of bars that can be shown is 10000.

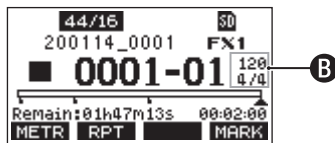

### TEMPO

This sets the tempo.

The setting range is from 20 to 250 (BPM). (Default: 120)

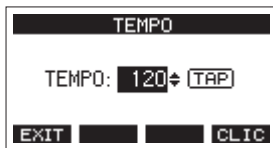

Turn the **MULTI JOG** dial to set the tempo.

The **CLICK** button can also be tapped repeatedly at the desired tempo to set it.

When the footswitch function is "TAP", the footswitch can also be used for input. (see "Setting up the footswitch" on page 47.)

### NOTE

Press the **F4 CLIC** button to turn the click sound on/off during tempo setting.

### SIGNATURE

Set the time signature to 4/4, 3/4, etc.

The setting range is from 1/1 to 12/8. (Default: 4/4)

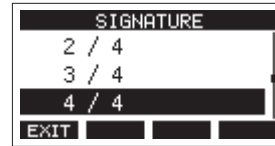

### SOUND

This sets the click sound.

Options: **CLICK** (default), **STICK**, **BELL**, **KICK**, **SNARE**, **PEDAL HIHAT**, **OPEN HIHAT**, **CLOSE HIHAT**

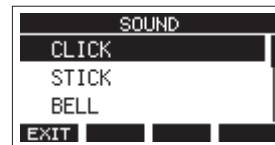

### ACCENT

This sets the strength of the click sound accent.

Options: OFF, LOW, MID (default), HIGH

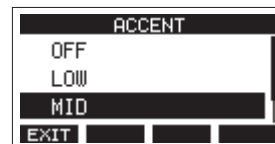

## 9 - Other functions

### Setting the count in function

When the click sound output setting is set to COUNTIN+REC, counting in before recording is possible.

The click sound pattern played before recording starts can be set.

1. When the recorder is stopped, select CLICK on the MENU Screen, and open the CLICK Screen. (see "Menu operation procedures" on page 18.)
2. Select COUNT IN on the CLICK Screen, and open the COUNT IN Screen.

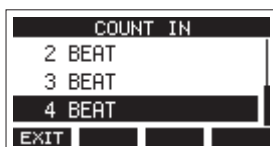

3. Turn the MULTI JOG dial to set the count in type.

Option	Meaning
1 SIGNATURE	One bar of beats for the set SIGNATURE are output. The first beat of the bar is accented.
2 SIGNATURES	Two bars of beats for the set SIGNATURE are output. The first beat of the bar is accented.
4 SIGNATURES	Four bars of beats for the set SIGNATURE are output. The first beat of the bar is accented.
2+4 BEAT	Regardless of the signature setting, one bar of half notes followed by one bar of quarter notes are output. No beat is accented.
2 BEAT	Regardless of the signature setting, two quarter notes are output. No beat is accented.
3 BEAT	Regardless of the signature setting, three quarter notes are output. No beat is accented.
4 BEAT (default)	Regardless of the signature setting, four quarter notes are output. No beat is accented.

4. Press the MULTI JOG dial to confirm the setting. The CLICK Screen reopens.

### Starting and stopping the metronome manually

The metronome can be started and stopped at any time by pressing the CLICK button.

- Press the CLICK button when the metronome is off to start it.
- Press the CLICK button when the metronome is on to stop it.

### Opening the METRONOME Screen with a function button

When the Home Screen is open, press the SHIFT button to show the **F4** button **CLIC** function. This can be used to open the METRONOME screen, where metronome functions can be set, from the Home Screen.

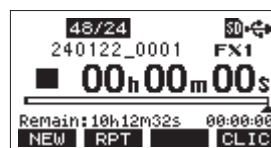

Home Screen when the SHIFT button is pressed

Press the **F4** **CLIC** button to open the METRONOME Screen.

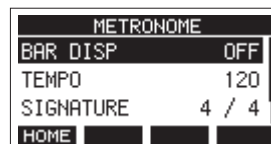

## MIDI functions

This unit can generate MIDI TIMECODE and MIDI CLOCK when the recorder is playing back or recording. The generated MIDI data is output from the MIDI OUT connector and simultaneously sent to a computer connected by USB. A DAW, for example, can be set to synchronize with the MIDI time code from this unit so it can operate in time with the recorder of this unit. For details, check the operation manual of the hardware or software product being used. MIDI settings are made on the following screen.

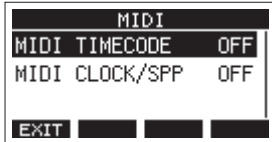

## Setting MIDI time code operation

When MIDI time code is enabled, it sends quarter-frame messages during playback and recording. It sends full messages when locating.

1. When the recorder is stopped, select MIDI TIMECODE on the MIDI Screen, and open the MIDI TIMECODE Screen. (see "Menu operation procedures" on page 18.)

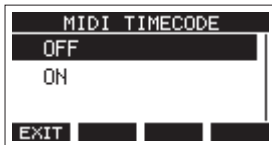

2. Turn the MULTI JOG dial to set MIDI time code operation.

Option	Meaning
OFF (default)	MIDI time code is not transmitted.
ON	MIDI time code is transmitted.

### NOTE

The MIDI time code frame type sent by this unit is 30 frames per second (non-drop).

3. Press the MULTI JOG dial to confirm the setting. The MIDI Screen reopens.

## Setting MIDI CLOCK/SPP

When MIDI CLOCK/SPP is enabled, MIDI CLOCK is sent during playback and recording. Song position pointers are sent when locating. The MIDI Clock timing and song positions sent depend on the metronome settings.

1. When the recorder is stopped, select MIDI CLOCK/SPP on the MIDI Screen, and open the MIDI CLOCK/SPP Screen. (see "Menu operation procedures" on page 18.)

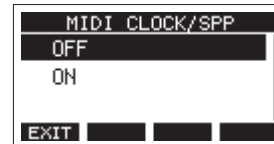

2. Turn the MULTI JOG dial to set whether or not MIDI CLOCK/SPP is sent.

Option	Meaning
OFF (default)	MIDI CLOCK/ SPP is not sent.
ON	MIDI CLOCK/ SPP is sent.

3. Press the MULTI JOG dial to confirm the setting. The MIDI Screen reopens.

# 9 - Other functions

## Mixer functions

### Selecting the output position of recording signals from the MAIN MIX L/R bus

The point where signals are sent from the MAIN MIX L/R bus to be recorded on the SD card can be selected.

- When the recorder is stopped, select MIXER on the MENU Screen, and open the MIXER Screen. (see "Menu operation procedures" on page 18.)



- Select MAIN REC POS on the MIXER Screen, and open the MAIN REC POSITION Screen.

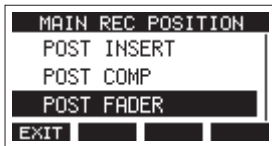

- Turn the MULTI JOG dial to select the send position.

Option	Meaning
POST INSERT	The signal recorded to the SD card is from before the MASTER BUS PROCESSOR.
POST COMP	The signal recorded to the SD card is from after the MASTER BUS PROCESSOR.
POST FADER (default)	The signal from after the MAIN fader is recorded to the SD card.

#### NOTE

- Audio sent to the computer will also be the same as the MAIN REC POSITION Screen setting.
  - If POST COMP is selected when the MASTER BUS IN switch is off, the compressor will be applied to signals recorded to the SD card, Audio signals output from the MAIN OUTPUT jacks will not have compression applied.
- Press the MULTI JOG dial to confirm the setting. The MAIN REC POSITION Screen reopens.

### REC OUT switch function (channels 1–12, 13/14–19/20)

The signals that are sent from each channel for recording to the SD card can be set to before the compressor or after the equalizer.



Off: Before compressor  
On (POST-EQ): After equalizer

The audio sent to the computer depends on the INPUT SEL and REC OUT switch settings of each channel as follows.

REC OUT switch	COMP/EQ	INPUT SEL switch	Audio sent to computer
Off	Disabled	MIC/LINE	Audio from input jacks is sent.
		USB	
		MTR	
On (POST-EQ)	Enabled	MIC/LINE	Audio from input jacks is sent.
		USB	Audio from computer is sent.
		MTR	MTR audio is sent.* * Recording is not possible with this setting.

- The REC button cannot be turned on for channels with INPUT SEL switches set to MTR and REC OUT switches set to on (POST-EQ). When set this way, the REC button will blink rapidly, warning that the setting is in error. Set the INPUT SEL switch to something other than MTR, turn off the REC OUT switch, or turn off the REC button, for example, to resolve this.

#### CAUTION

During recording, setting the INPUT SEL switch to MTR and turning the REC OUT switch on (POST-EQ) on a channel being recorded could cause a loud noise to be output. Do not set it this way during recording.

## Footswitch functions

### Setting up the footswitch

Use the FOOTSW Screen to set the footswitch.

Two footswitches can be connected by using a commercially-available Y-cable.\* The function and polarity can be set separately for each footswitch.

\* Y-cable with 1 standard TRS plug (male) and 2 standard TS jacks (female) (tip/ring split)

#### NOTE

When connecting a footswitch directly without using a Y-cable, the FOOTSW1 settings will be used. In this case, set FOOTSW2 to OFF.

#### TIP

Dual-type unlatched footswitches with standard TRS plugs can also be used.

1. When the recorder is stopped, select FOOTSW on the SYSTEM Screen, and open the FOOTSW Screen. (see "Menu operation procedures" on page 18.)

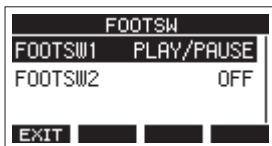

2. Select FOOTSW1 or FOOTSW2 from the list, and open the corresponding footswitch settings screen.



3. Select the MODE item, and open the MODE Screen.

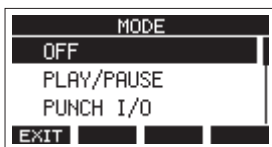

4. Turn the MULTI JOG dial to select the function to assign to the footswitch.

Option	Meaning
OFF	No function is assigned to the footswitch.
PLAY/PAUSE (default)	Press to start playback when stopped or paused. Press to pause when playing.
PUNCH I/O	Press during playback to punch in. Press when recording to punch out.
FX MUTE	Mute the built-in effect signal.
REC/STOP	Start/stop recording.
MARKER	Add a mark to the song.
MARK SKIP	Move to the next mark.
LOAD NEXT SONG	Load the next song.
TAP	Use in the same way as the CLICK button on the EFFECT and TEMPO screens.

5. Press the MULTI JOG dial to confirm the assigned function. The FOOTSW screen reopens.

## 9 - Other functions

### Setting the footswitch polarity

The setting of this unit can be changed according to the polarity of the footswitch being used.

1. When the recorder is stopped, select FOOTSW on the SYSTEM Screen, and open the FOOTSW Screen. (see "Menu operation procedures" on page 18.)
2. Select FOOTSW1 or FOOTSW2 from the list, and open the corresponding footswitch settings screen.



3. Select the POLARITY item, and open the POLARITY Screen.

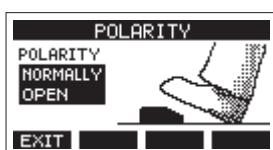

4. Turn the MULTI JOG dial to set the footswitch polarity. Select "NORMALLY OPEN" or "NORMALLY CLOSED" so that the actual footswitch movement matches that shown by the illustration on the screen.

Options: NORMALLY OPEN (default), NORMALLY CLOSED

#### NOTE

When using a TASCAM RC-1F, set the POLARITY switch to "N.OPEN".

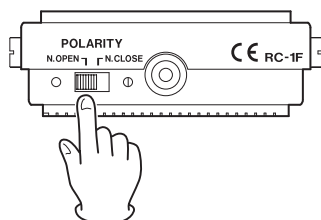

5. Press the **F1** **EXIT** button to return to the FOOTSW Screen.

#### NOTE

Dual-type footswitches can also be connected. Refer to the operation manual of the footswitch for how to connect and set it.

### DAW CONTROL

This unit has DAW control functions. By setting it to DAW control mode, the controls of this unit can be used for basic operation of the DAW application. This includes recording, playing, stopping and other transport functions.

Mackie Control and HUI protocol emulation are supported, so Cubase, Digital Performer, Logic, Live, Pro Tools, Cakewalk and other major DAW applications can be controlled.

For details about DAW control mode, download the DAW Control Mode Manual from the page for this product on the TEAC Global Site (<https://teac-global.com/>).

### Quick song creation function

The quick song creation function can be used to easily create new songs without working with the SONG Screen in the menu. When the recorder is stopped and the Home Screen is open, press the **F1** **NEW** button while pressing the SHIFT button.

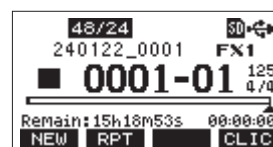

This will create and load a new song that uses the same sampling frequency, bit length and metronome settings of the currently loaded song.



#### NOTE

If a song is created using the quick song creation function when no song is loaded, the song will be created using the sampling frequency, bit length and metronome settings currently used by the unit.



## MASTER BUS PROCESSOR functions

Using the MASTER BUS PROCESSOR, a 4-band digital equalizer and stereo compressor can be applied to MAIN MIX L/R bus signals and then output from the MAIN OUTPUT jacks. In addition, playback of stereo master files recorded to the SD card can also be output from the MAIN OUTPUT jacks.

### Outputting signals from the MAIN OUTPUT jacks after they pass through the MASTER BUS PROCESSOR

When the MASTER BUS IN switch is on, signals will be output from the MAIN OUTPUT jacks after passing through the MASTER BUS PROCESSOR. The indicator lights when this switch is on.

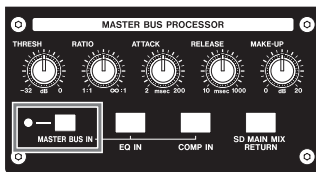

### Setting the MASTER BUS PROCESSOR equalizer (master section equalizer)

The LOW and HIGH EQ bands are shelving while the MID-LOW and MID-HIGH bands are parametric.

#### Turning on/off the master section equalizer

Briefly press the EQ IN button to switch on/off the master section equalizer. The EQ IN button will light when the equalizer is on.

#### Adjusting the master section equalizer

1. When the Home Screen is open, press and hold the EQ IN button to open the MASTER EQ Screen where the MASTER BUS PROCESSOR equalizer can be adjusted.

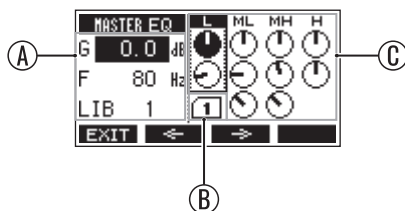

A	G: Gain	C	L: LOW
	F: Central frequency		ML: MID LOW
	Q: Band width		MH: MID HIGH
	LIB: Library number		H: HIGH
B	Library number		

The setting values of the band framed by the rectangle are shown in the left area.

2. Turn the MULTI JOG dial to change the selected parameter.

Band	Parameter	Range
HIGH	Gain	-12 dB - +12 dB
	Cutoff frequency	1.7 kHz - 18 kHz
MID HIGH	Gain	-12 dB - +12 dB
	Central frequency	32 Hz - 18 kHz
	Band width	0.10 - 17.31
MID LOW	Gain	-12 dB - +12 dB
	Central frequency	32 Hz - 18 kHz
	Band width	0.10 - 17.31
LOW	Gain	-12 dB - +12 dB
	Cutoff frequency	32 Hz - 1.6 kHz

3. Press the MULTI JOG dial to move the selection down.
  - Use the **F2** and **F3** buttons to move the selection left and right.
4. Repeat step 2 and 3 as necessary to adjust the equalizer.

#### NOTE

- When the MULTI JOG dial is turned, the **F4** button will become the **UNDO** button. Press the **F4 UNDO** button to return to the state before turning the MULTI JOG dial.
- After undoing, the **F4** button will become the **REDO** button. Press the **F4 REDO** button to return to the state before undoing.
- While the SHIFT button is pressed, the **F4** button becomes the **INI** button. Press the **F4 INI** button to set a parameter value to its default.

## 9 - Other functions

### Setting the MASTER BUS PROCESSOR compressor (master section compressor)

#### Turning on/off the master section compressor

Briefly press the COMP IN button to switch on/off the master section compressor. The COMP IN button will light when the compressor is on.

#### Adjusting the master section compressor

- When the Home Screen is open, press and hold the COMP IN button to open the MASTER COMP Screen where the MASTER BUS PROCESSOR compressor can be adjusted.

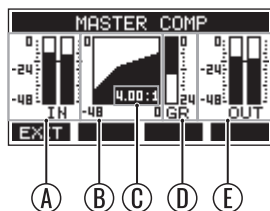

- Ⓐ: Signal levels input to compressor
  - Ⓑ: Compressor setting graph
  - Ⓒ: Ratio setting value
  - Ⓓ: Gain reduction level
  - Ⓔ: Signal level after compressor
- Use the THRESH (threshold level), RATIO, ATTACK (attack time), RELEASE (release time) and MAKE-UP (make-up gain) knobs to adjust the compressor.

Parameter	Range
Threshold	-32 – 0 dB
Ratio	1:1 – ∞:1
Attack	2 – 200 ms
Release	10 – 1000 ms
Make-up gain	0 – 20 dB

### Using the SD MAIN MIX RETURN function

Using the SD MAIN MIX RETURN function, playback of stereo master files recorded on the SD card can be output from the MAIN OUTPUT jacks.

- Press the SD MAIN MIX RETURN button to turn on the SD MAIN MIX RETURN function. This will input the playback of the stereo master file recorded on the SD card to the MASTER BUS PROCESSOR. The SD MAIN MIX RETURN button will light when the SD MAIN MIX RETURN function is on.

#### ATTENTION

Be aware that when this switch is on (pushed in), the sound of the MAIN MIX L/R bus is not output.

#### NOTE

The SD MAIN MIX RETURN function cannot be used when in SD PLAY mode.

### Using the library

This master section equalizer has a library function that allows up to 10 setting presets to be saved.

#### Saving equalizer settings in the library

- Open the MASTER EQ Screen.
- Move the selection to the LIB item.
- Turn the MULTI JOG dial to select the library number you want to use for saving.

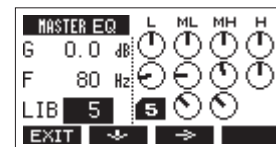

- Follow the procedures in “Setting the MASTER BUS PROCESSOR equalizer” to set the equalizer. This saves the equalizer settings in the library.

#### Using equalizer settings saved in the library

- Open the MASTER EQ Screen.
- Move the selection to the LIB item.
- Turn the MULTI JOG dial to select the library number with the saved equalizer settings you want to use. These settings will be applied to the master bus equalizer.

# 10 - Settings and Information

## Viewing information

Use the INFORMATION screen to view various types of information about the unit. Follow the procedures below to view the INFORMATION screen.

1. When the recorder is stopped, select INFORMATION on the SYSTEM Screen, and open the Information Screen. (see "Menu operation procedures" on page 18.)

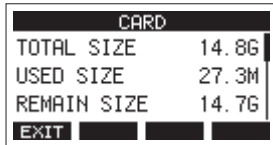

The Information Screen has 3 pages. The CARD page opens first.

2. Turn the MULTI JOG dial to cycle through the CARD, SONG and SYSTEM screens.

**CARD Screen**

Shows the use status of the currently loaded SD card.

**SONG Screen**

Shows the number of songs on the loaded SD card.

**SYSTEM Screen**

Shows the unit's system firmware version.

3. Press the **F1 EXIT** button to return to the SYSTEM Screen.

## CARD Screen

The CARD Screen shows the status of the currently loaded SD card.

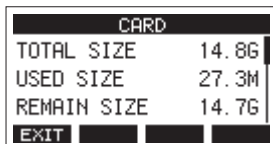

### TOTAL SIZE

Shows the total amount of space on the SD card.

### USED SIZE

Shows the amount of space used on the SD card.

### REMAIN SIZE

Shows the amount of space unused on the SD card.

## SONG Screen

The SONG Screen shows the use status of the "MTR" folder.



### TOTAL SONG

This shows the total number of songs in the "MTR" folder.

## SYSTEM Screen

The SYSTEM Screen shows information about this unit.

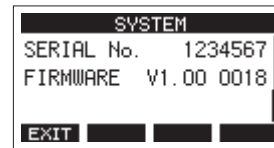

### SERIAL No.

This shows the serial number of this unit.

### VERSION

This shows the system firmware version of this unit.

## Setting the song name format

Set the name format used by the unit for created songs.

1. When the recorder is stopped, select SONG NAME on the SYSTEM Screen, and open the SONG NAME Screen. (see "Menu operation procedures" on page 18.)

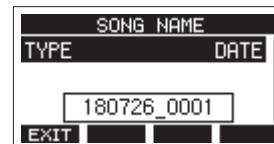

2. Set the file name format.

Option	Meaning
DATE (default)	Use the date for the song name. (Example: 180101_0001)
WORD	Use the 6-character song name set on the WORD EDIT screen. (Example: TASCAM_0001)

### NOTE

The date is set using the unit's internal clock. (see "Setting the built-in clock date and time" on page 22.)

3. Press the **F1 EXIT** button to return to the SYSTEM Screen.

## Setting the WORD item

To set the characters, select WORD on the TYPE Screen. An EDIT item will appear on the SONG NAME Screen that can open the WORD EDIT Screen.



For details about how to set characters, see "Editing text" on page 27.

# 10 - Settings and Information

## Restoring factory default settings

You can restore the various settings stored in the memory of the unit to their factory default values.

Use the following menu procedures to do so.

1. When the recorder is stopped, select INITIALIZE on the SYSTEM Screen, and open the INITIALIZE Screen. (see "Menu operation procedures" on page 18.)

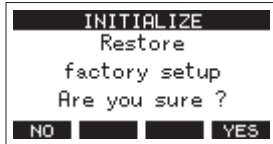

2. Press the **F4 YES** button to restore the factory default settings.
3. When the setting completes, the SYSTEM Screen will reopen.

### NOTE

- Press the **F1 NO** button to cancel execution.
- The date and time setting is not initialized.

## Formatting SD cards

Formatting erases all music files on the SD card and automatically creates new "MTR", "MUSIC" and "UTILITY" folders as well as a "tascam\_m.sys" file.

### ATTENTION

- Formatting an SD card erases all the data on it. This cannot be undone.
- Always use this unit to format media to be used with it. Operation of this unit might be affected when using an SD card that has been formatted by a computer or other device.

1. When the recorder is stopped, select MEDIA FORMAT on the SYSTEM Screen, and open the MEDIA FORMAT Screen. (see "Menu operation procedures" on page 18.)

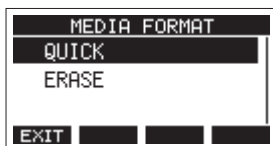

QUICK: Execute quick formatting.

ERASE (Recommendation): Erase and format the card.

2. Select the format method, and press the MULTI JOG dial. A confirmation message will appear on the QUICK or ERASE Screen.

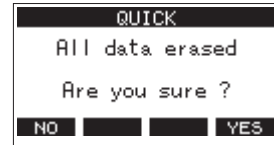

Shown when QUICK selected

### NOTE

Press the **F1 NO** button to cancel formatting and return to the previous screen.

3. Press the **F4 YES** button to start formatting.
4. When formatting is complete, the SYSTEM Screen will reopen.

### NOTE

- Pressing the **F1 STOP** button during an ERASE format will cancel erasure and execute a QUICK format instead.
- The writing speeds to SD cards and other storage media that use flash memory tend to decrease after writing occurs repeatedly. If the writing speed decreases, this could have a negative impact on recording. Using the ERASE function of this unit should restore the writing speed of the SD card.\* For this reason, we recommend using the ERASE function at the following times.
  - Whenever the card has been written to until it became completely full
  - On a regular schedule (about once per month)
  - Before starting important recordings

\* Writing speed might not be restored depending on the SD card condition (including malfunction and age).

## Playing WAV files on SD cards (SD PLAY mode)

The WAV files in the "MUSIC" folder on an SD card can be played back. (see "Loading WAV files from a computer" on page 55.)

To play files recorded on this unit, use the stereo mix export function to convert the recorded (mono) files to a single stereo file. Then, use the SD PLAY mode to play it. (see "Stereo mix export function" on page 40.)

The following audio file formats can be played back in SD PLAY mode.

WAV: 44.1/48 kHz, 16/24-bit

BWF: 44.1/48 kHz, 16/24-bit

### NOTE

Playback signal is sent from channels 21 and 22.

1. Set the channel 21/22 INPUT SEL switch to "MTR".
2. Set the channel 21/22 PAN/BAL knob to the center position.
3. When the recorder is stopped, select SD PLAY on the MENU Screen, and open the SD PLAY Screen. (see "Menu operation procedures" on page 18.)

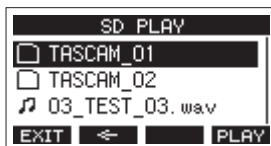

4. Select a file to play back.
  - Turn the MULTI JOG dial to select a WAV file.
  - Press the MULTI JOG dial when a folder is selected to show its contents.
  - Press the **F1** **EXIT** button to return to the MENU Screen.
  - Press the **F2** **←** button to move up one level.

### NOTE

Only WAV files can be played back. Unsupported files will not be shown.

5. Press the **F4** **PLAY** button or **▶/||** button to start WAV file playback.

The SD PLAY Screen will show playback status.



- Press the **F1** **EXIT** button to return to the file selection screen.
- Press the **F2** **RPT** button to turn the repeat playback function on and select the repeat playback mode.

Display	Meaning
No indicator	The folder that contains the currently playing WAV file will play back, and then playback will stop.
↻1	The currently playing WAV file will play back repeatedly.
↻ALL	The folder that contains the currently playing WAV file will play back repeatedly.

- Press the **F3** **<<** button to skip to the beginning of the WAV file. Press near the beginning of the WAV file to skip to the beginning of the track before it.
  - Press the **F4** **>>** button to skip to the beginning of the next WAV file.
6. Press the **F1** **EXIT** button twice to return to the MENU Screen.

# 11 - Using a computer to transfer data

By connecting this unit with a computer using a USB cable, you can back up song data on the SD card in the unit to the computer, as well restore backed up song data to the unit. You can also export track and stereo master files from songs to the computer and import audio files from the computer.

Backed up data can be restored to other Model 2400 units. Since this allows you to freely move files between Model 2400 units, you can easily conduct additional recording or mixing at different locations.

## ATTENTION

You can conduct the same operations by removing the SD card from the unit and connecting it directly to a computer or by using a card reader instead of using USB to connect the unit and the computer. Turn the unit's power off or stop operation before removing the SD card.

This unit can transfer the following data to a computer.

## Entire songs

This unit can transfer all the data for a song from the "MTR" folder to a computer. This operation is called "backing up". Data backed up to a computer can also be transferred to the "MTR" folder, and restored as a song file. This operation is called "restoring".

## ATTENTION

Do not change names, delete or otherwise alter individual files inside the "MTR" folder. Doing so could prevent loading data as a song and make proper recording and playback operations impossible.

## WAV files

By placing WAV files from the computer into the "MUSIC" folder, you can import them to song tracks. Moreover, WAV files in the "MUSIC" folder can be played back in SD PLAY mode.

## Connecting with a Computer

To connect with the computer, use a USB cable with a Type-B (USB 2.0) connector on one end and a connector that matches the computer USB port on the other end (USB-IF certification recommended). Connect the USB port on the back of this unit to a USB port on the computer.

The USB cable can be connected either before or after turning this unit on.

## ATTENTION

- If using this unit as external storage media with a computer, recorder functions, including recording and playback, cannot be used when in USB storage mode.
- The unit should be connected directly with the computer instead of via a USB hub. Moreover, noise could be picked up if the cable is too long.

1. Use a USB cable to connect USB ports on the computer and this unit.

2. On the MENU Screen, select STORAGE to open the STORAGE Screen. (see "Menu operation procedures" on page 18.)



3. To connect with the computer, press the **F4 YES** button. The unit enters USB storage mode and connects with the computer.



Make sure that the SD card is inserted properly.

4. This unit appears on the computer as an external drive named "TASCAM\_M" (if the card was formatted by this unit).
5. Click the "TASCAM\_M drive" on the computer to show the "MTR", "MUSIC" and "UTILITY" folders.

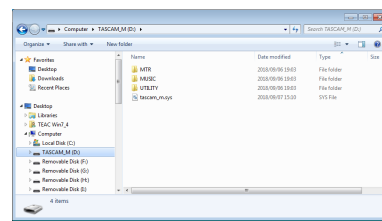

## ATTENTION

- This unit receives power through its power cord. It cannot be powered by USB.
- Do not disconnect the power cord or turn off the power during data transfer. Data will be lost if the power is interrupted during transfer. Lost data cannot be restored.
- Do not change the names of folders in "TASCAM\_M".

## NOTE

- Do not change names, delete or otherwise alter individual files inside the "MTR" folder.
- The "UTILITY" folder is used when updating the unit system, for example.

6. Press the **F1 EXIT** button to return to the Meter Screen.

## Disconnecting

Before disconnecting the USB cable, use the proper procedures for your computer to unmount the unit (as an external drive).

See the computer's operation manual for instructions about how to unmount an external volume.

Press the **F1 EXIT** button to disconnect from the computer and return to the Home Screen.

---

## Loading WAV files from a computer

---

1. Use a USB cable to connect USB ports on the computer and this unit. (see "Connecting with a Computer" on page 54.)
2. Click the "Model 2400" drive on the computer to show the "MTR", "MUSIC" and "UTILITY" folders.
3. Drag and drop files on the computer that you want to transfer to the unit to the "MUSIC" folder.

### ATTENTION

- The "UTILITY" folder is used when updating the unit system, forexample.
- Do not change names, delete or otherwise alter individual files inside the "MTR" folder. Doing so could prevent loading data as a song and make proper recording and playback operations impossible.

### TIP

- You can manage the content of "MTR" or "MUSIC" folders from the computer.
- You can create subfolders in the "MUSIC" folder up to the second level for use with this unit. The Mlode 2400 cannot recognize sub-folders and files located at the third layer level or below.

# 12 - USB audio interface functions

## Installing the dedicated software

To use this unit as a USB audio interface with a Windows computer, dedicated software must be installed on the computer.

Download the latest software from the product page on the TEAC Global Site (<https://teac-global.com/>).

Installing the dedicated software will install a driver and a Settings Panel application.

### ATTENTION

Before starting to install software, quit other applications.

### NOTE

With a Mac, the standard OS driver will be used, so installation of dedicated software is not strictly necessary. We recommend installing this software, however, because it has a notification function about updates for the unit firmware and software.

## Installing the Windows dedicated software

### ATTENTION

- Complete installation of the Windows dedicated software on the computer before connecting the unit to it with the USB cable.
- If you connected the unit to the computer using the USB cable before installing the Windows dedicated software and the “Found New Hardware Wizard” launched, close the Wizard and disconnect the USB cable.

## Windows dedicated software installation procedures

1. Download the latest Windows dedicated software from the TEAC Global Site (<https://teac-global.com/>) and save it on the computer to be used with the unit.
2. Uncompress the saved software (zip file) on the computer desktop or another location.
3. Double-click the “TASCAM\_Model\_Mixer\_Installer\_x.xx.exe” file in the folder that appears after uncompression to launch the installation software.

### ATTENTION

If you open a zip file without decompressing it and doubleclick the “TASCAM\_Model\_Mixer\_Installer\_x.xx.exe” file in the folder that opens, installation will not start. Right-click the zip file and select “Extract All”, for example, to decompress it and then try again.

4. When a “Security Warning” or “User Account Control” screen appears, click the “Yes” button.

5. Read the contents of the License Agreement, and select “I accept the agreement” if you agree to the terms. Then, click the “Next >” button.

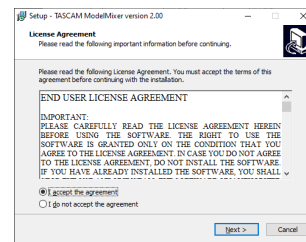

6. Next, click the “Install” button.

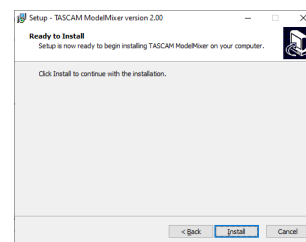

7. The following screen appears when installation has completed. Click the “Finish” button.

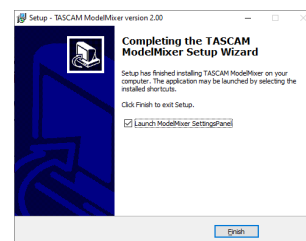

The installer will quit and the Windows Settings Panel will launch.

### NOTE

The first time you connect the unit by USB to the computer after installing the software, installation of the device driver will be executed. Some time might be necessary before the unit is recognized because Windows Update will be automatically searched at this time. If the unit is still not recognized after a while, open the software installation screen from the notification area at the bottom right of the computer display, and click “Skip obtaining driver software from Windows Update” to stop the search.



# 12 - USB audio interface functions

## Installing the Mac dedicated software

### NOTE

- Install the Mac dedicated software on the computer before connecting the unit to it with the USB cable.
- Depending on the Gatekeeper setting, a warning message might appear during installation. Please see “Working with Gatekeeper” on page 57 for information about Gatekeeper.

## Mac dedicated software installation procedures

1. Download the latest Mac dedicated software for the operating system you are using from the TEAC Global Site (<https://teac-global.com/>) and save it on the computer to be used with the unit.
2. Double-click “TASCAM\_MODEL MIXER\_Installer\_x.xx.dmg”, which is the saved disk image file for the Mac dedicated software, and double-click “ModelMixer\_Installer.pkg” inside the folder that opens.



ModelMixer\_Installer.pkg

### NOTE

Depending on the computer's settings, the downloaded zip file might not have been uncompressed automatically. In this case, uncompress the zip file first and then double-click the disk image file.

3. When the installer starts, click the “Continue” button.

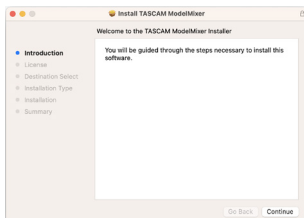

4. Next, select the desired language and click the “Continue” button.

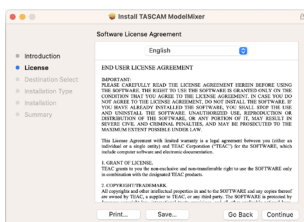

5. Click the “Read License” button and check the contents of the Software License Agreement. If you agree to the contents of the license, click “Agree”. Then, click the “Continue” button.

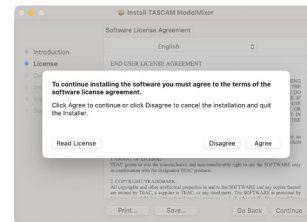

6. Next, click the “Install” button to start installation.

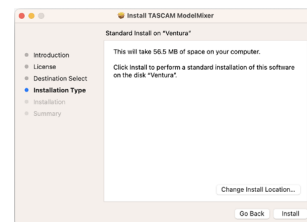

7. The following screen appears when installation has completed. Click the “Close” button.

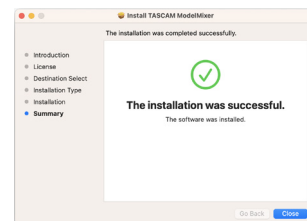

## Working with Gatekeeper

When using macOS, depending on the Gatekeeper security function setting, a warning message might appear during installation.

The solution depends on the warning message shown. See the following explanations for details.

## When the Gatekeeper setting is “Allow applications downloaded from: the Mac App Store”

The following security warning might be shown:

“ModelMixer\_Installer.pkg” can't be opened because it was not downloaded from the Mac App Store.”

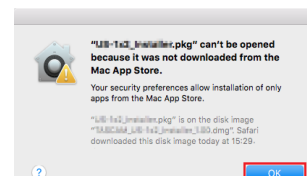

In this case, click the “OK” button to close the message. Then, control-click (or right-click) the file and click “Open” in the menu.

# 12 - USB audio interface functions

When the “ModelMixer\_Installer.pkg” can’t be opened because it was not downloaded from the Mac App Store. Are you sure you want to open it?” security warning message appears, click the “Open” button.

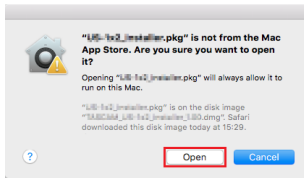

This warning message might also appear when the Gatekeeper setting is something other than “Allow applications downloaded from: the Mac App Store.” The file still might not open and “ModelMixer\_Installer.pkg” can’t be opened because it was not downloaded from the Mac App Store.” might appear again.

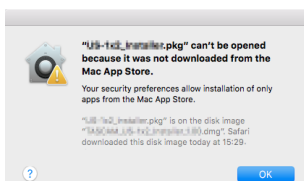

In this case, copy the file from the folder where it is to the desktop or another folder, and then open it. Alternatively, change the Gatekeeper settings to “Allow apps downloaded from: App Store and identified developers” and try opening it again.

## When the Gatekeeper setting is “Allow applications downloaded from: the Mac App Store”

“TASCAM\_MODEL MIXER\_Installer\_x.xx.dmg” is an application downloaded from the Internet. Are you sure you want to open it?” might appear as a security warning message. In this case, click the “Open” button.

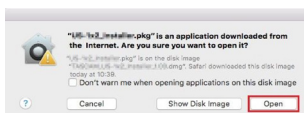

## Changing the Gatekeeper setting

The Gatekeeper setting can be changed using the “Allow applications downloaded from:” item on the “General” page of the “Security & Privacy” pane of the System Preferences. To change this, you must click the lock icon (🔒) at the bottom left and enter a password to unlock the settings.

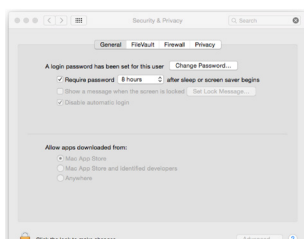

This setting will lock again when you close the System Preferences by clicking the button or typing command-Q, for example, or when you click “Show All” to close the open pane.

## ATTENTION

Changing the Gatekeeper settings could result in security risks. If you changed the Gatekeeper setting to decrease security (use one of the lower settings), set it back to the original setting after updating the driver and/or firmware.

## Uninstalling the dedicated software

### NOTE

Normally, there is no need to uninstall the dedicated software. Follow these procedures if a problem occurs or you no longer intend to use the unit with the computer.

## Uninstalling the Windows dedicated software

1. Open the “Uninstall or change a program” screen using the procedures for the operating system being used (Windows 11/Windows 10).
2. Select “TASCAM Model\_Mixer x.xx” from the list, and double-click it.
3. Then, follow the instructions that appear on the screen.

## Uninstalling the Mac dedicated software

Delete “TASCAM Model\_Mixer” from the Application folder to complete uninstallation.

## Opening the Settings Panel

Open the Settings Panel in the following manner.

### Windows

- From the “Start” menu select “TASCAM Model Mixer” under “TASCAM”

### Mac

- On the Launchpad, click “TASCAM Model Mixer”.
- Using the Finder, open the Applications folder and click “TASCAM Model Mixer” to open the Settings Panel.

## Settings Panel overview

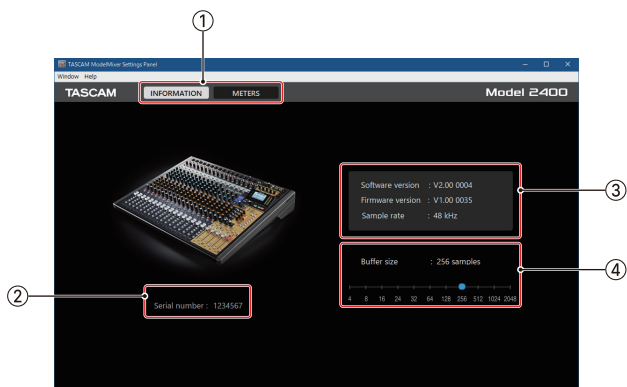

Settings Panel INFORMATION Screen

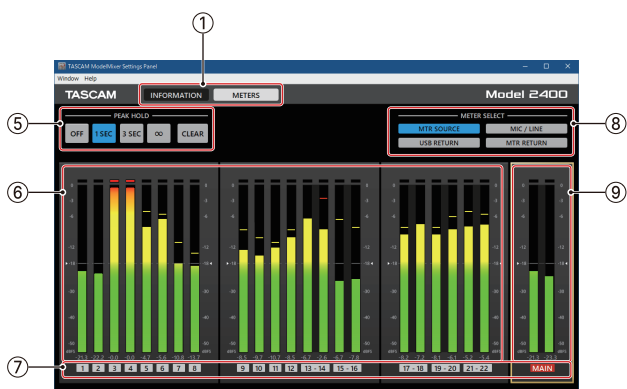

Settings Panel METERS Screen

### ① Screen selection buttons

Tap these buttons to switch the Settings Panel screen shown.

Button	Use
INFORMATION	This opens the INFORMATION Screen, which shows information and other details about the unit.
METERS	This opens the Meter Screen, which shows the meters.

### ② Serial number

This shows the serial number of the unit.

### ③ Status display area

This shows the current status of the software.

Item displayed	Meaning
Software Ver	This is the software version.
Firmware Ver	This is the firmware version used by the connected unit.
Device	This is the name of the connected unit. ("No Device" is shown when no device is connected.)
Sample Rate	This shows the sampling frequency of the current song. If an SD card is not loaded, this shows the sampling frequency set by the computer.

### ④ Buffer Size (Windows only)

You can adjust the size of the buffer used to handle the audio input and output signals transferred to and from the computer.

Smaller buffer sizes result in less audio signal delay (latency), but require high-speed processing by the computer.

If the processing cannot keep up, for example, due to other system operations, clicking and popping noises might occur and the audio signal might even drop out.

Increasing the buffer size will stabilize operation and suppress negative effects on audio signals, but the delay in audio signals sent to the computer will increase.

You can use the slider on the panel to adjust the buffer size for this unit according to the use conditions.

#### Options

4, 8, 16, 24, 32, 64, 128, 256 (default), 512, 1024, 2048

- On macOS, adjust this within the DAW.

### ⑤ PEAK HOLD setting buttons

Tap these buttons to set peak hold display on the meters.

Button	Explanation
OFF	Peak hold will not be shown.
1 SEC	The peak level will be held for 1 second.
3 SEC	The peak level will be held for 3 seconds.
∞	The peak level will be held until it is cleared.
CLEAR	This clears the peak hold.

### ⑥ Channel level meters

These show the signal levels (pre-fader) of all channels selected with METER SELECT buttons.

Level values are shown at the bottom of the level meters. The unit is dBFS. Peak holds can be individually cleared by clicking around these numbers.

### ⑦ Channels

These show the channel numbers.

When MTR SOURCE is selected, these show the REC button states of the unit channels.

The MAIN area always shows the REC button status.

The colors of the channel numbers indicate the following states.

Color	Explanation
Black	The state of the REC button cannot be shown.
Gray	The REC button is not pressed for this channel.
Blinking red	The REC button is pressed for this channel.
Lit red	The REC button is pressed for this channel, which is recording.

# 12 - USB audio interface functions

## ⑧ METER SELECT buttons

Tap these buttons to select the signals shown by the level meters.

Button	Explanation
MTR SOURCE	The levels of signals being input to the MTR (entering channel strips) will be shown.
MIC/LINE	The levels of signals being input to the MIC/LINE jacks will be shown.
USB RETURN	The levels of signals being input from USB will be shown.
MTR RETURN	The levels of signals being output from the MTR (playback audio) will be shown.

## ⑨ MAIN level meters

These show the MAIN MIX L/R bus signal levels (pre-fader). Level values are shown at the bottom of the level meters. The unit is dBFS.

## Notification function

If the computer you are using is connected to the Internet, the latest information about unit firmware and software, for example, can be shown when the Settings Panel is launched.

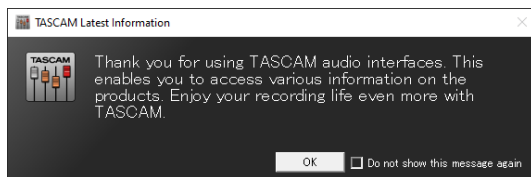

### NOTE

Put a check in the "Do not show the same message again" checkbox to prevent the same message from being shown the next time it is launched.

## Setting Sound Properties

1. Open the OS Control Panel.

### NOTE

Follow these procedures to open the Control Panel.

#### Windows 11

Click the Windows Start button, and from "All apps" click "Windows Tools" and then double-click "Control Panel".

#### Windows 10

Left-click the Windows Start button, and from "WindowsSystem" select "Control Panel".

2. Double-click "Sound" in the Control Panel.

### NOTE

If the Control Panel is set to be viewed as icons, a "Sound" icon will appear.

3. On the "Playback" page, right-click "Model 2400", and click "Set as Default Device" in the pop-up menu that appears. When you do this, the green check mark appears next to the selected device.

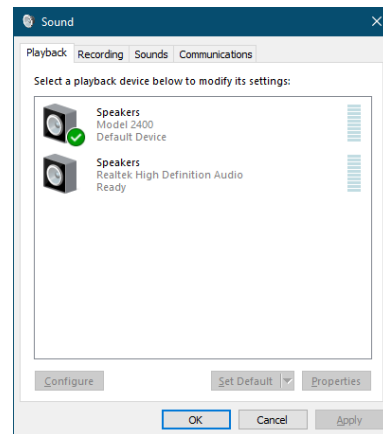

Windows 10 screen

### NOTE

Set the default device according to the ASIO device being used on the Recording tab in the same manner as on the Playback tab.

4. After completing the setting, click the "OK" button.
5. Launch Windows Media Player and start playback to input the playback sound from the computer to channels 1 and 2 on the Model 2400. (INPUT SEL switches: USB)

### NOTE

- If you change the setting while Windows Media Player is running, the software will not recognize that the device has been changed. In this case, restart Windows Media Player.
- If you still cannot hear sound after making the settings and completing the procedures above, restart the computer.
- If you make this setting, sound will be output through this unit, but no sound will be output from the computer's speakers or headphone jack.

# 12 - USB audio interface functions

## Simultaneous ASIO/WDM playback

The driver for this unit can simultaneously play ASIO output from a DAW and WDM output from Windows Media Player, for example. The sample rates of both sources must be set to the same value for simultaneous playback to be possible. Moreover, the sample rate must also be set to the same value for both playback and recording in the Windows Sound Properties.

### When the sample rates are the same

Example: Windows (WDM) at 44100 Hz, ASIO at 44100 Hz

The Windows audio and ASIO sound are mixed and played simultaneously.

### When the sample rates are different

Example: Windows (WDM) at 48000 Hz, ASIO at 44100 Hz

Only sound from a DAW and other ASIO sources are output. Sound from Windows Media Player and other WDM sources are not output.

When the DAW is shut down, for example, and output from ASIO sources stops, sound from Windows Media Player and other WDM sources will become audible.

## Make USB audio settings

### Setting the USB audio mode

The sound input to the computer can be changed to allow the MAIN MIX L/R bus signal to be sent to communication applications and streaming software.

1. When the recorder is stopped, select USB AUDIO on the SYSTEM Screen, and open the USB AUDIO Screen. (see "Menu operation procedures" on page 18.)

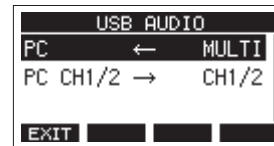

2. Select PC ← on the USB AUDIO Screen, and open the TO PC Screen.



3. Turn the MULTI JOG dial to select the audio to input to the computer.

Option	Meaning
MULTI INPUT (default)	The inputs of channels 1–12, 13/14 and 21/22 and the output of the MAIN MIX L/R bus are input to USB channels 1–24.
STEREO MIX	The output of the MAIN MIX L/R bus is input to USB channels 1–2.

4. Press the MULTI JOG dial to confirm the setting. The USB AUDIO Screen will reopen.

# 12 - USB audio interface functions

## Setting the USB return channel function

By using the USB return channel function, audio sent from computer USB channels 1–2 can be input on mixer channels of this unit other than 1–2.

When using with an application that supports two-channel audio devices (including OBS Studio) on a Windows computer, it is also possible to use with mics, for example, connected to mixer channels 1–2 of this unit.

- When the recorder is stopped, select USB AUDIO on the SYSTEM Screen, and open the USB AUDIO Screen. (see "Menu operation procedures" on page 18.)

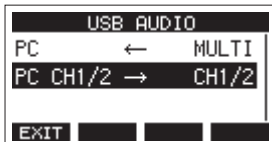

- Select PC CH1/2 → on the USB AUDIO Screen, and open the FROM PC CH1/ 2 Screen.

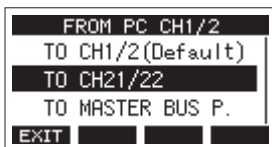

- Turn the MULTI JOG dial to select the assignment for the audio sent from computer USB channels 1–2.

Option	Meaning
TO CH1/2 (default)	Audio sent from computer USB channels 1–2 will be input on mixer channels 1–2 of this unit (USB return channel function not used).
TO CH21/22	Audio sent from computer USB channels 1–2 will be input on mixer channels 21/22 of this unit. This is a useful setting when using mic input on mixer channels 1–2 of this unit while adjusting audio from the computer when streaming, for example.
TO MASTER BUS P.	Audio sent from computer USB channels 1–2 will be mixed with signals input to the MASTER BUS PROCESSOR of this unit's mixer. With this setting, when using this unit for audio interface input in DAW control mode, all analog inputs for mixer channels 1–22 of this unit can be sent to the DAW while monitoring the playback sound from the DAW.

- When a setting other than "TO CH1/2" is selected, sound will not be input from the computer to channels 1–2 of the mixer of this unit.
  - When "TO MASTER BUS P." is selected, turn on the MASTER BUS IN switch on the unit.
- Press the MULTI JOG dial to confirm the setting. The USB AUDIO Screen will reopen.

- When using the USB return channel function, the USB icons shown on the Home Screen when connected by USB will be different.



Indicator appearance	Meaning
	"TO CH1/2" selected (USB return channel function not used)
	"TO CH21/22" selected
	"TO MASTER BUS P." selected

- An **OLY** icon appears on the Home Screen when the OUTPUT DELAY function is used. The USB icon will not be shown.

## Setting procedures for use with OBS Studio and other streaming applications

Conduct the procedures in this document before launching the streaming application.

### Model 2400 unit settings

- Set the MODEL 2400 USB audio mode to STEREO MIX. (see "Setting the USB audio mode" on page 61.)
- To enable the MAIN fader for streamed audio, set the position from which MAIN MIX L/R bus signals are sent to "POST FADER". (see "Analog output adjustment section" on page 13.)

- For Macs, the above settings make use with streaming applications possible.

### Windows computer sound settings

Set the input and output device, sampling frequency, bit rate, and number of channels according to the setup.

- Open the Sound Settings screen.

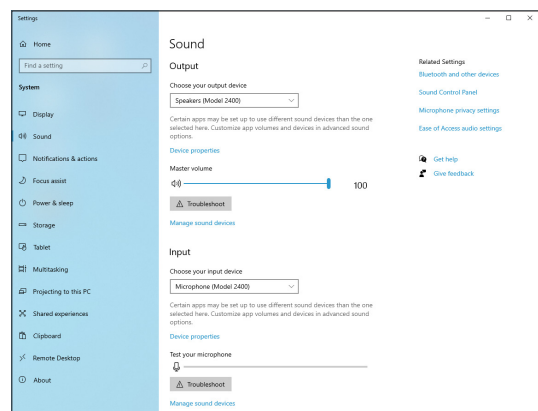

### NOTE

This can also be opened by right-clicking the sound icon at the bottom right of the desktop screen, selecting "Open Sound settings" and then selecting "Sound".

# 12 - USB audio interface functions

2. Set the output device to "Speakers (Model 2400)".
3. Set the input device to "Microphone (Model 2400)".
4. Click "Sound Control Panel" to open the Sound window.
5. Open the Recording tab, and select "Model 2400".

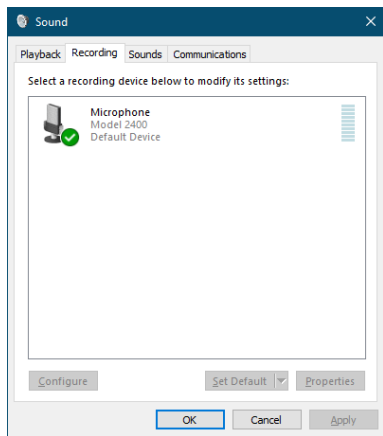

6. Click "Properties" for "Model 2400" to open the Microphone Properties screen.
7. Open the Advanced tab, and set the Default Format.

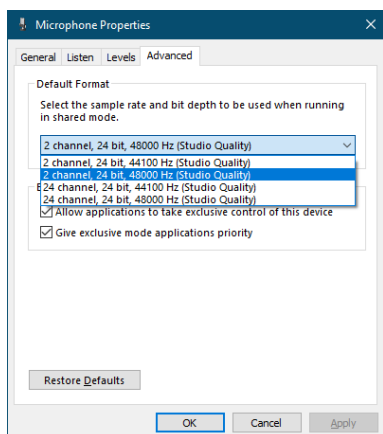

- Select a 2-channel setting when using OBS Studio or another application that supports 2-channel audio devices. Otherwise, select a 24-channel setting.
- Select the sample rate according to the sample rate of the song loaded in the unit. Any sample rate can be used when not loading a song.

8. Open the Playback tab, and select "Speakers (Model 2400)".

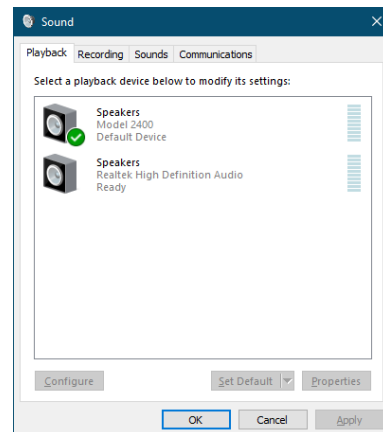

9. Click "Properties" for "Speakers (Model 2400)" to open the Speakers Properties screen.
10. Open the Advanced tab, and set the Default Format. Set the sample rate and bit depth for the Default Device on the Play tab to the same values set on the Record tab.

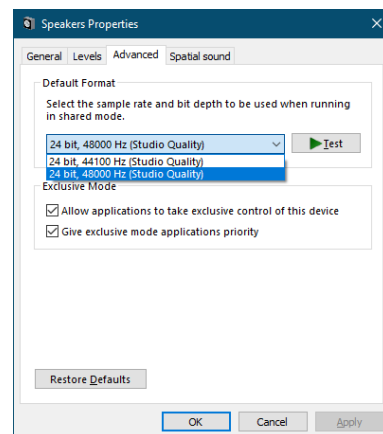

11. Launch the streaming application, and proceed with streaming and other functions.
12. After completing streaming, restore the settings to multichannel to use multiple channels with other applications as necessary.
  - In step 1, set the USB audio mode to MULTI INPUT.
  - In step 7, set the Microphone Properties to 24-channel.

# 13 - USB OUTPUT DELAY function

During live Internet streaming, when capturing audio with a different device from the camera video, lags could occur between the streamed video and audio.

If the video is behind the audio, an offset delay can be added intentionally to audio from the Model 2400 USB output to correct the lag between the video and audio.

Even though delay could be applied using the streaming application, this function is useful because applying offset delay using the Model 2400 can reduce the load on that application.

1. When the recorder is stopped, select OUTPUT DELAY on the SYSTEM Screen, and open the OUTPUT DELAY Screen. (see "Menu operation procedures" on page 18.)
2. Select DELAY on the OUTPUT DELAY Screen, and open the DELAY Screen.

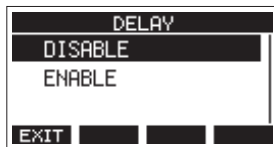

3. Turn the MULTI JOG dial to enable/disable the OUTPUT DELAY function that applies delay to USB audio.

Option	Meaning
DISABLE (default)	Do not use the OUTPUT DELAY function
ENABLE	Use the OUTPUT DELAY function

4. Press the MULTI JOG dial to confirm the setting. The OUTPUT DELAY Screen reopens.
5. Press the **F1** **EXIT** button to return to the SYSTEM Screen.

## NOTE

An **DLY** icon appears on the Home Screen when the OUTPUT DELAY function is on (set to ENABLE).



## Setting the delay time of the OUTPUT DELAY function

1. When the recorder is stopped, select OUTPUT DELAY on the SYSTEM Screen, and open the OUTPUT DELAY Screen.
2. Select DELAY TIME on the OUTPUT DELAY Screen, and open the DELAY TIME Screen.



3. Turn the MULTI JOG dial to set the delay time. Setting range: 0 (default) – 2000 (in 1 ms steps)

## NOTE

The **F3** **-100** and **F4** **+100** buttons change the delay time in 100ms steps rather than in 1ms steps. They do not decrease/increase the delay time –100/+100 ms.

4. Press the MULTI JOG dial to confirm the setting. The OUTPUT DELAY Screen will reopen.
5. Press the **F1** **EXIT** button to return to the SYSTEM Screen.



# 14 - MIDI Implementation Chart

## MIDI Implementation Chart

Function		Transmit	Recognize	Remarks
Basic channels	When power on	×	×	Thru
	Settable	×	×	
Mode	When power on	×	×	Thru
	Messages	×	×	
	Altered	.....		
Note number	Range	×	×	Thru
Velocity	Note on	×	×	Thru
	Note off	×	×	
Aftertouch	Polyphonic	×	×	Thru
	Channel	×	×	
Pitch bend		×	×	Thru
Control change		×	×	Thru
Program change		×	×	Thru
	Setting range	.....		
System exclusive		○*1	×	Thru
System common	Position	○*3	×	Thru
	Song select	×	×	
	Quarter frame	○*2	×	
	Tune	×	×	
System real-time	Clock	○*3	×	Thru
	Command	×	×	
Other	Local on/off	×	×	Thru
	All notes off	×	×	
	Active sense	×	×	
	Reset	×	×	

### Notes

\*1 MTC full message when MIDI TIMECODE is ON

\*2 When MIDI TIMECODE is ON

\*3 When MIDI CLOCK/SPP is ON

Mode 1: OMNI ON, POLY Mode 2: OMNI ON, MONO  
 Mode 3: OMNI OFF, POLY Mode 4: OMNI OFF, MONO

○: YES  
 ×: NO

# 15 - Messages

The following is a list of messages that appear in pop-up windows.

Refer to this list if one of these pop-up messages appears on the Model 2400 and you want to check the meaning or determine a proper response.

Message	Meaning and response
Card Error	The SD card cannot be recognized properly. Replace the SD card.
Card Full	The SD card has no remaining capacity.
Dup File Name	A file with the same name already exists. Change the file name.
File Not Found	The file cannot be found or the file may be damaged. Check the relevant file.
No sys file Make sys file	The system file is missing. This unit requires a system file for operation. When this message appears, press the MULTI JOG dial to create a system file.
Song Protected	This operation is not possible because the song is protected. Remove protection.
Invalid Card Change Card	Something might be wrong with the SD card. Change the SD card.
I/O Too Short	On the AUTO PUNCH Screen, the time between the punch in and out points is too short. Set them with at least 1 second between them.
MBR error Init card	The SD card is not formatted properly or the card is broken. Change the SD card or press the MULTI JOG dial while this message is being shown to format the card. Formatting will erase all the data on the SD card.
No Card	A SD card is not set. Insert a recordable SD card.
Non-supported	The file format is not supported. Please see "Playing WAV files on SD cards (SD PLAY mode)" on page 53 for file formats that this unit can use.
Card Protected	The SD card is write-protected. Disable SD card write-protection.
USB Fs mismatch	The sampling rate of the current song and the USB audio interface are not the same. Change the sampling rate of one so that they are the same.
Current Song	The current song cannot be deleted. To delete the current song, load another song first.
Invalid I/O point	The punch in/out point settings on the AUTO PUNCH Screen are not set correctly. Automatic punching in/out occurred at an invalid position for the punch in or out point. Start the automatic punch operation from a valid point.
Write error REC continue	Writing to the SD card timed out. This has caused audio to be interrupted and noise to occur.
REC stop Card slow	Writing to the SD card timed out, and recording stopped. SD card writing performance has become worse. Execute the erase format function or change the SD card.
Need to set I/O point.	Neither the punch in or out points are set for the automatic punch in/out function. Either the punch in or out point must be set.
Sample rate Unmatch	The sampling frequency of the WAV file to be imported does not match the current song. Select a WAV file with the same sampling frequency as the current song or convert the sampling frequency before importing.
Remain time is not enough	The SD card does not have enough open space, so importing is not possible. Erase unnecessary files or transfer them to a computer.
8 track punch in limit	The maximum number of tracks for punch in recording is eight. Press REC buttons to reduce the number of recording tracks to eight or less.
Song is not loaded	No song is loaded. Create a new song or load a song.
Song number full	The maximum number of songs that can be created on an SD card is 100. Erase unnecessary songs.
SD PLAY: cannot record	SD PLAY mode is for playback only. Recording is not possible.
SD CARD cluster size error	Recording is not possible because the SD card cluster size is not right. Back up the contents of the SD card on a computer and then format it with this unit. Then, restore the data from the computer.
Import error. No track	Importing is not possible because there are no open tracks. Use TRACK CLEAR to clear a track. (see "Clearing tracks" on page 37.)
Invalid track	The selected track cannot be used for replacement. Change the track selection on the TRACK SWAP screen. (see "Swapping tracks" on page 38.)
Already protected	The selected song is already protected.

Message	Meaning and response
Already unprotected	The selected song is already unprotected.
Unexpected shutdown, preserved.	<p>The power was interrupted unexpectedly during recording. A temporary file of the recording at the time the power was interrupted might remain in the song folder on the SD card.</p> <p>The song is in a protected state. Removing protection will delete temporary files. If a temporary recording file is needed, copy it to a computer, for example, before removing protection from the song.</p>
Wrong settings of REC POST-EQ	<p>The following unit settings have been made.</p> <ul style="list-style-type: none"> <li>• INPUT SEL switch set to MTR</li> <li>• REC OUT switch set to on (POST-EQ)</li> <li>• REC button on (blinking or lit)</li> </ul> <p>In this state, noise or other issues could occur. Set the INPUT SEL switch to something other than MTR, turn off the REC OUT switch, or turn off the REC button, for example, to resolve this.</p>
SD MAIN MIX RETURN not available	The SD MAIN MIX RETURN function cannot be used when in SD PLAY mode.
Can't Save Data	<p>If any of these errors occurs, turn the unit off and restart it. If these error messages continue to appear frequently, please contact the store where you purchased this unit or TASCAM customer support.</p>
Device Error	
File Error	
Not Continued	
Player Error	
UNDO not available	
Writing Failed	
Sys Rom Err	
System Err XX (XX is a number.)	

# 16 - Troubleshooting

If you are having trouble with the operation of this unit, please try the following before seeking repair.

If these measures do not solve the problem, please contact the store where you bought the unit or TASCAM customer support service.

## The unit will not turn on

- Confirm that the power plug and other connectors are inserted completely.

## The SD card is not recognized

- Turn the power off and remove and re-insert the SD card several times. Then, confirm that it is inserted completely.

## No sound is output

- Are the input sources and INPUT SEL switches set properly?
- Are the channel faders raised to suitable levels?
- Is the MAIN fader raised to a suitable level?
- Is a monitoring system correctly connected to the PHONES jack or CONTROL ROOM L/R jacks?  
Is the monitoring system set up correctly?
- Is the PHONES knob or CONTROL ROOM knob placed to a suitable level?
- Are any of the channel PFL switches or bus AFL on?

## The sound I want to record is distorted

- Are the channel GAIN knobs set too high?  
Are the input source levels too high?
- Is the EQ set too high?
- Are any channel faders or the MAIN fader raised too high?
- Is the monitoring level too high, causing the monitoring system to distort?

## Noise occurs when a passive guitar or bass is connected directly

- Connecting another device to the unit's SUB OUTPUT jacks (stereo output) could reduce noise.
- It could be affected by interference noise from another device, for example. If a power amplifier or other device with a large transformer, or a fluorescent light, for example, is nearby, changing the distance or orientation of such devices could reduce noise.

## Playback is not possible

- If you are trying to play a WAV file, confirm that it uses a sampling frequency (44.1/48 kHz) and a bit depth (16/24-bit) that are supported by this unit.

## There is noise

- Confirm that the connection cables do not have contact issues.

## Sound via Bluetooth breaks up or is noisy

- Are there any wireless LAN devices, other Bluetooth devices, microwave ovens or similar equipment nearby?  
Keep such devices as far away as possible during use.
- Try reducing the distance between this unit and the other Bluetooth device. Try changing the positions of this unit and the other Bluetooth device.
- The operation of apps other than for music playback on the smartphone could cause the sound to break up. In this case, stop operation of apps other than the one used for music playback.

## Sound via Bluetooth breaks up or is noisy

- Confirm that the other Bluetooth device power is on and that its Bluetooth function is on.
- Confirm that the other Bluetooth device is not too far away.  
Are there walls or other obstacles, for example, between this unit and the other Bluetooth device?  
Try changing the positions of this unit and the other Bluetooth device.
- Turn OFF and restart the Model 2400.
- Remove the "Model 2400" pairing record from the other Bluetooth device, and try pairing the unit with that Bluetooth device again. (see "Connecting with Bluetooth devices" on page 21.)

## Cannot pair with another Bluetooth device

- Confirm that the other Bluetooth device supports A2DP.
- Confirm that the other Bluetooth device is in a state that allows transmission. For details, check the operation manual of that Bluetooth device.
- Turn the power off for both this unit and the other Bluetooth device once, turn them both on again and try pairing them.
- Turn off Bluetooth devices other than the one that you are trying to pair with.
- Remove the "Model 2400" pairing record from the other Bluetooth device, and try pairing the unit with that Bluetooth device again. (see "Connecting with Bluetooth devices" on page 21.)

### **A computer does not recognize the unit when connected by USB**

- Has the dedicated software been installed? (see "Installing the dedicated software" on page 56.)
- This unit cannot be used with USB 1.1. Use a USB 2.0 or USB 3.0 port.
- Do not use a USB hub with this unit. Always connect the unit directly to a USB port on the computer.
- If the above methods do not resolve the problem, connect the unit to a different USB port on the computer.

### **When connected by USB, sound breaks up or noise occurs.**

- The processing load on the computer causes sound to break up and noise to occur.
- If a wireless LAN or background software, including antivirus software, is running, turn it off during use of this unit. In addition, please use "computer's power option" as "high performance setting".
- Use the shortest USB cable possible.
- Use a USB port built into the computer because the computer USB port affects the USB connection.

# 17 - Specifications

---

## Recorder specifications

---

### Supported media

- SD cards (Class 10 or higher)
- SDHC cards (Class 10 or higher)
- SDXC cards (512 GB maximum, Class 10 or higher)

### File System

- SD card: FAT16
- SDHC card: FAT32
- SDXC card: exFAT

### Recording file formats

- WAV (BWF): 44.1/48 kHz, 16/24-bit (Maximum file size: 2 GB)

### Playback file formats

- WAV, BWF: 44.1/48 kHz, 16/24-bit

### Recordable Channel

- Max. 24 channels (22ch + 2 stereo mix)

---

## Inputs and outputs

---

### Analog audio input and output ratings

#### MIC input jacks (1–12, 13, 15, 17, 19)

- Connectors: XLR combo jacks  
XLR-3-31 equivalent (1: GND, 2: HOT, 3: COLD)
- Maximum input level: +10 dBu
- Nominal input level: –8 dBu
- Minimum input level: –58 dBu
- Gain adjustment range: 0 – 50 dB
- Input impedance: 1.9 k $\Omega$  (1–12), 2.4 k $\Omega$  (13, 15, 17, 19)

#### LINE/INST input jacks (1–2)

- Connectors: 6.3mm (1/4") standard TRS jacks  
(Tip: HOT, Ring: COLD, Sleeve: GND)
- Maximum input level: +22 dBu (LINE)/19.8 dBV (INST)
- Nominal input level: +4 dBu (LINE)/ 1.8 dBV (INST)
- Gain adjustment range: –10 – +40 dB
- Input impedance: 22 k $\Omega$  (LINE)/1 M $\Omega$  (INST)

#### LINE input jacks (3–12)

- Connectors: 6.3mm (1/4") standard TRS jacks  
(Tip: HOT, Ring: COLD, Sleeve: GND)
- Maximum input level: +22 dBu
- Nominal input level: +4 dBu
- Gain adjustment range: –10 – +40 dB
- Input impedance: 22 k $\Omega$  or higher

#### LINE L/MONO, R input jacks (13/14–21/22)

- Connectors: 6.3mm (1/4") standard TRS jacks  
(Tip: HOT, Ring: COLD, Sleeve: GND)
- Maximum input level: +22 dBu
- Nominal input level: +4 dBu
- Gain adjustment range: –20 – +30 dB
- Input impedance: 11 k $\Omega$  or higher (Mono),  
22 k $\Omega$  or higher (Stereo)

#### INSERT jacks (1–12)

- Connectors: 6.3mm (1/4") standard TRS jacks  
(Tip: SEND, Ring: RETURN, Sleeve: GND)

##### RETURN (Ring)

- Maximum input level: +18 dBu
- Nominal input level: 0 dBu
- Input impedance: 15 k $\Omega$

##### SEND (Tip)

- Maximum output level: +18 dBu
- Nominal output level: 0 dBu
- Output impedance: 100  $\Omega$

#### TALKBACK input jack

- Connectors: XLR-3-31 equivalent (1: GND, 2: HOT, 3: COLD)
- Maximum input level: –22 dBu
- Minimum input level: –65 dBu
- Gain adjustment range: 52 dB
- Input impedance: 2.6 k $\Omega$  or higher

#### MAIN OUTPUT L/R jacks

- Connectors: XLR-3-32 equivalent (1: GND, 2: HOT, 3: COLD)
- Maximum output level: +22 dBu
- Nominal output level: +4 dBu
- Output impedance: 200  $\Omega$

#### MAIN SEND/RETURN L/R jacks

- Connectors: 6.3mm (1/4") standard TRS jacks  
(Tip: SEND, Ring: RETURN, Sleeve: GND)

##### RETURN (Ring)

- Maximum input level: +18 dBu
- Nominal input level: 0 dBu
- Input impedance: 9 k $\Omega$  or higher

##### SEND (Tip)

- Maximum output level: +18 dBu
- Nominal output level: 0 dBu
- Output impedance: 100  $\Omega$

#### CONTROL ROOM L/R jacks

- Connectors: 6.3mm (1/4") standard TRS jacks  
(Tip: HOT, Ring: COLD, Sleeve: GND)
- Maximum output level: +16 dBu
- Nominal output level: –2 dBu
- Output impedance: 200  $\Omega$

## AUX OUTPUT jacks (1–5)

Connectors: 6.3mm (1/4") standard TRS jacks  
(Tip: HOT, Ring: COLD, Sleeve: GND)  
Maximum output level: +16 dBu  
Nominal output level: –2 dBu  
Output impedance: 200 Ω

## SUB OUTPUT jacks (1–2/3–4/5–6/7–8)

Connectors: 6.3mm (1/4") standard TRS jacks  
(Tip: HOT, Ring: COLD, Sleeve: GND)  
Maximum output level: +16 dBu  
Nominal output level: –2 dBu  
Output impedance: 200 Ω

## PHONES jack (1/2)

Connector: 6.3mm (1/4") standard stereo jack  
Maximum output: 80mW + 80mW (32Ω load)

---

## Control input/output

### USB port

Connector: USB Type-B  
Protocol: USB 2.0 HIGH SPEED (480 Mbps)

### CLICK jack

Connector: 6.3mm (1/4") standard TRS jacks  
(Tip: HOT, Ring: COLD, Sleeve: GND)

### FOOTSWITCH jack

Connector: 6.3mm (1/4") standard TRS jacks  
(Tip: FOOTSW1, Ring: FOOTSW2, Sleeve: GND,  
Unlatch type correspondence)

### MIDI OUT connector

Connector: 5-pin DIN  
Format: standard MIDI

### MIDI IN connector

Connector: 5-pin DIN  
Format: standard MIDI

---

## Operating system and computer requirements

---

Check the TEAC Global Site (<https://teac-global.com/>) for the latest information about supported operating systems.

### ATTENTION

Operation with each OS was confirmed with standard system setups that met the following conditions. Operation is not guaranteed, however, with all systems that meet the following conditions.

### Model 2400

#### Windows

- Supported operating systems
- Windows 11
  - Windows 10 64-bit
- Computer hardware requirements
- Windows computer with a USB 2.0 (or higher) port
  - Using the TASCAM driver
  - Operation not guaranteed with ARM64 CPUs

#### Mac

- Supported operating systems
- macOS Sonoma (14)
  - macOS Ventura (13)
- Computer hardware requirements
- Mac with a USB 2.0 (or higher) port

#### iOS/iPadOS devices

- iOS 17/iPadOS 17
- iOS 16/iPadOS 16

To connect an iOS device that has a Lightning connector, a genuine Apple Lightning to USB Camera Adapter (sold separately) is necessary.

A USB cable is necessary when connecting to an iOS device that has a USB Type-C connector.

### Settings Panel (application)

#### Windows

- Windows 11
- Windows 10 64-bit

#### Mac

- macOS Sonoma (14)
- macOS Ventura (13)

#### Screen resolution/number of colors

- 1280×720 or higher
- True Color (32-bit) recommended

# 17 - Specifications

---

## Audio performance

---

### Noise

Residual output noise (22kHz, A-weighted)  
–100 dBu (MAIN MIX OUT: ALL FADER MIN, MAIN MIX OFF)  
Equivalent input noise (EIN)  
–128 dBu ( $R_s = 150 \Omega$ , MIC IN → INSERT SEND, gain knob at MAX, A-weighted)

### Total harmonic distortion ratio (THD+N)

(Gain knob at MIN, 1 kHz)  
MIC IN → MAIN OUT: 0.01% or less  
MIC IN → MAIN OUT: 0.004% @  
(+2 dBu, BYPASS switches on)

### Frequency response

(All GAIN knobs minimized, 1 kHz)  
20 Hz to 30 kHz (+0.5/–1.0 dB: Analog)  
20 Hz to 20 kHz (+0.5/–1.0 dB: Digital)

### Crosstalk

(1 kHz, BPF)  
Between channels: –80 dB

### Maximum gain

(All GAIN knobs maximized, PAN knobs turned completely left or right, BYPASS switches on, MASTER BUS IN switch off)  
MIC → MAIN OUT: 74 dB  
MIC → INSERT OUT: 54 dB  
MIC → SUB OUT: 74 dB  
MIC → AUX OUT: 75 dB  
USB/SD → MAIN OUT: 24 dB

---

## Recording times

---

Recording format	Recording time (hours: minutes) for 32GB card
16-bit/44.1 kHz WAV, 24 tracks	4:10
16-bit/48 kHz WAV, 24 tracks	3:50
24-bit/44.1 kHz WAV, 24 tracks	2:47
24-bit/48 kHz WAV, 24 tracks	2:33

- The recording times shown above are estimates. They might differ depending on the SD card in use.

---

## Bluetooth

---

### Bluetooth version: 5.1

Output class: 2 (about 10m\* unobstructed transmission distance)  
Supported profile: A2DP  
Supported A2DP codecs: SBC, AAC  
Supported A2DP content protection: SCMS-T

- \* The transmission distance is only an estimate and might vary depending on the surrounding environment and radio wave conditions.

---

## Other

---

### Power

AC 100-240V, 50/60Hz

### Power consumption

65W

### Dimensions

With side panels  
680.5 × 132.5 × 568.0mm (W x H x D, including protrusions)  
Without side panels  
638.5 × 132.5 × 568.0mm (W x H x D, including protrusions)

### Weight

14 kg

### Guaranteed operating temperature range

0 – 40°C (32 – 104°F)

### Guaranteed operating humidity range

5 – 85% (without condensation)



## Dimensional drawings

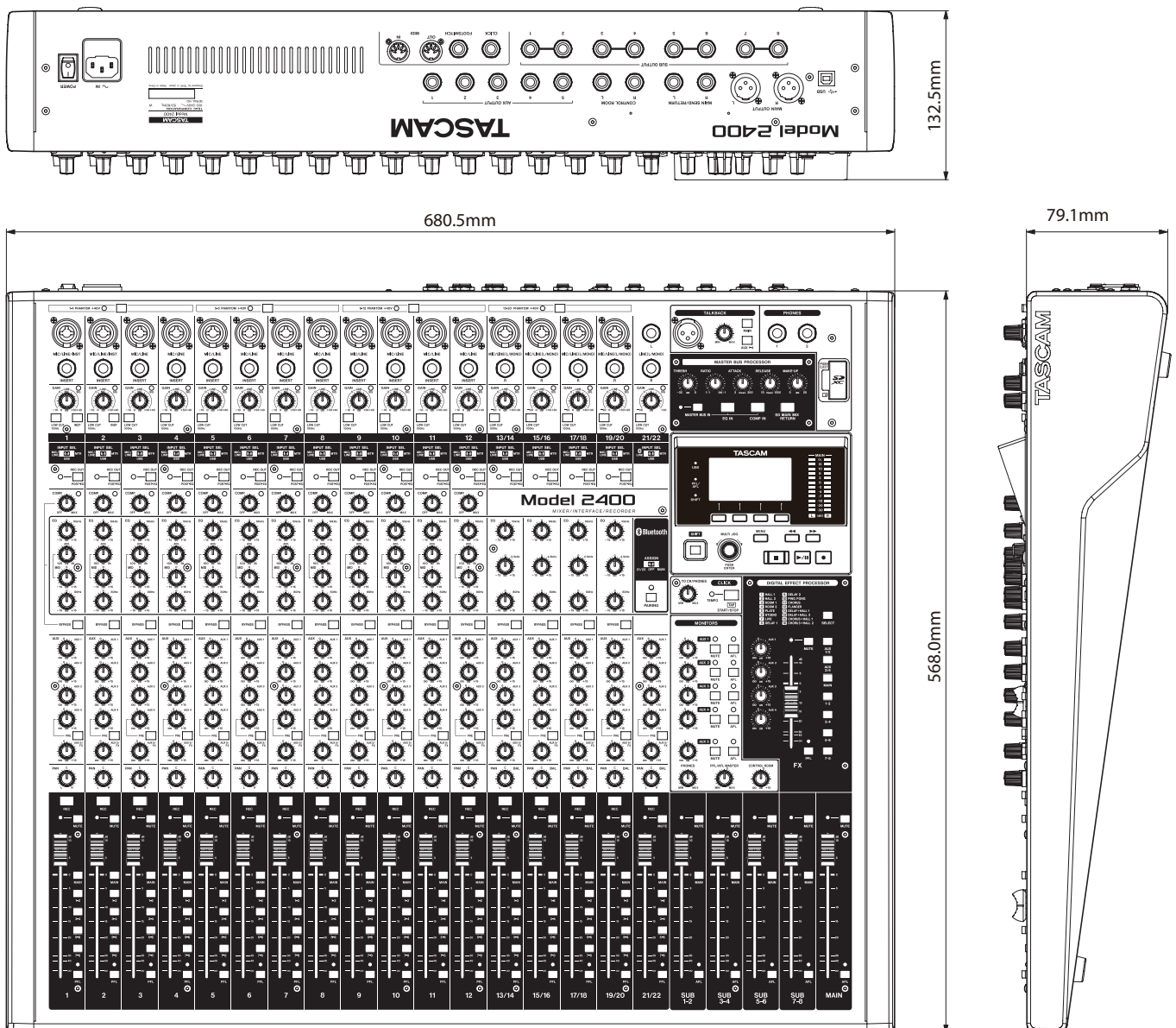

- Illustrations in this manual might differ in part from the actual product.
- Specifications and external appearance might be changed without notification to improve the product.

# 17 - Specifications

## Block diagram

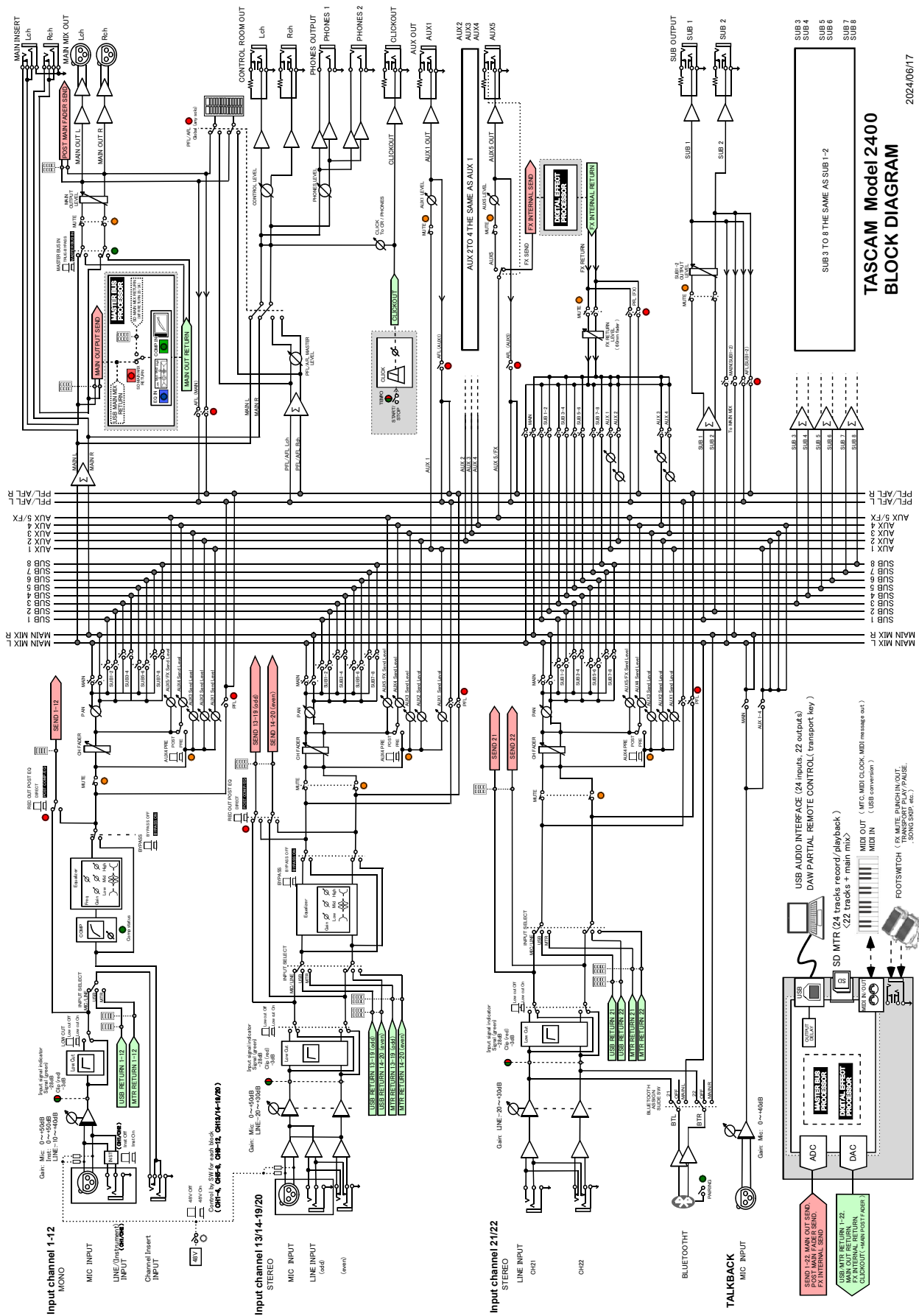

## Level diagram

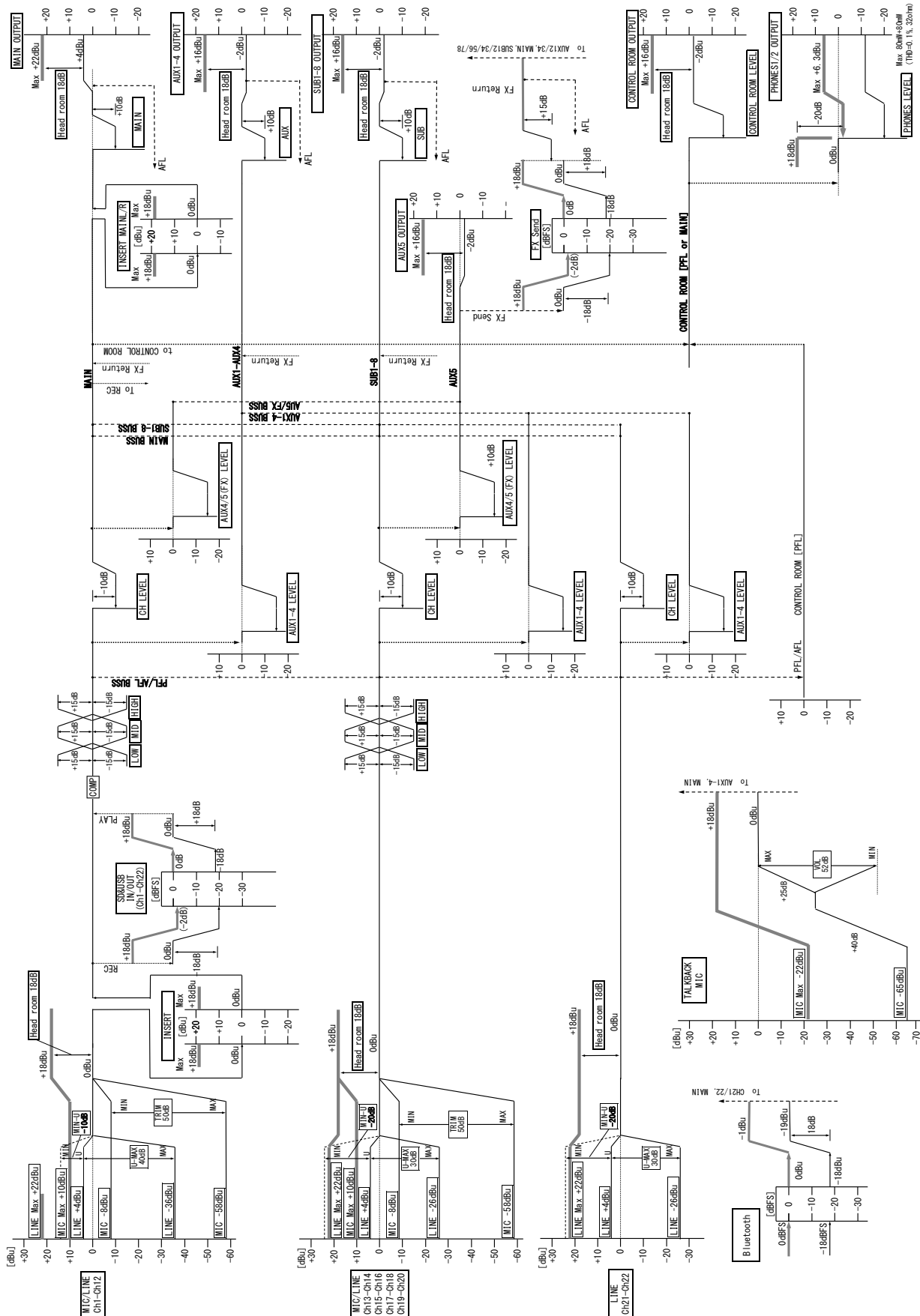

# TASCAM

## Model 2400 Recording track sheet

Artist	Producer	Bit depth / Sample / Tempo	
Title	Engineer	Start	
Data	Studio	End	

Track 01	Track 02	Track 03	Track 04	Track 05	Track 06	Track 07	Track 08
Track 09	Track 10	Track 11	Track 12	Track 13	Track 14	Track 15	Track 16
Track 17	Track 18	Track 19	Track 20	Track 21	Track 22	Track 23	Track 24

# TASCAM

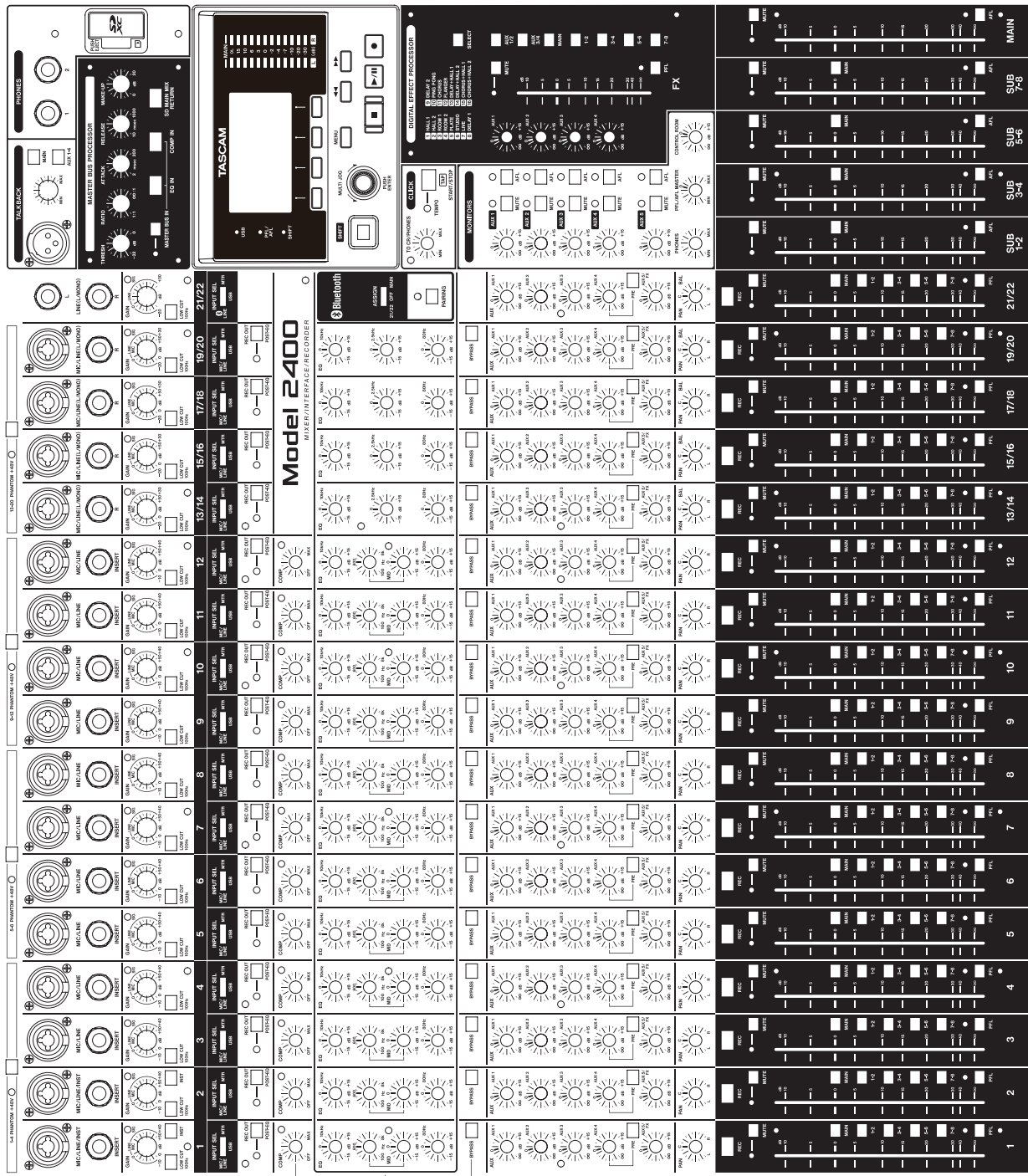

# TASCAM

TEAC CORPORATION

Phone: +81-42-356-9143

1-47 Ochiai, Tama-shi, Tokyo 206-8530 Japan

<https://tascam.jp/jp/>

---

TEAC AMERICA, INC.

Phone: +1-323-726-0303

10410 Pioneer Blvd., Unit #3, Santa Fe Springs, CA 90670, U.S.A

<https://tascam.com/us/>

---

TEAC UK Ltd.

Phone: +44-1923-797205

Luminous House, 300 South Row, Milton Keynes, Buckinghamshire, MK9 2FR, UK

<https://www.tascam.eu/en/>

---

TEAC EUROPE GmbH

Phone: +49-611-71580

Bahnstrasse 12, 65205 Wiesbaden-Erbenheim, Germany

<https://www.tascam.eu/de/>

---

TEAC SALES & TRADING(SHENZHEN) CO., LTD

Phone: +86-755-88311561~2

Room 817, Xinian Center A, Tairan Nine Road West, Shennan Road, Futian District, Shenzhen, Guangdong Province 518040, China

<https://tascam.cn/cn/>

---

0724. MA-3875A