



## User's Manual



**UCX-4x3-TPX-TX20 (-LCC)**  
**UCX-2x1-TPX-TX20 (-LCC)**

**UCX-3x3-TPX-RX20 (-LCC)**  
**HDMI-UCX-TPX-RX107**

Multimedia Signal Distribution Amplifier

## Important Safety Instructions

### Class II apparatus construction.

The equipment should be operated only from the power source indicated on the product.

To disconnect the equipment safely from power, remove the power cord from the rear of the equipment or from the power source. The MAINS plug is used as the disconnect device, the disconnect device shall remain readily operable.

There are no user-serviceable parts inside of the unit. Removal of the cover will expose dangerous voltages. To avoid personal injury, do not remove the cover. Do not operate the unit without the cover installed.

The appliance must be safely connected to multimedia systems. Follow instructions described in this manual.

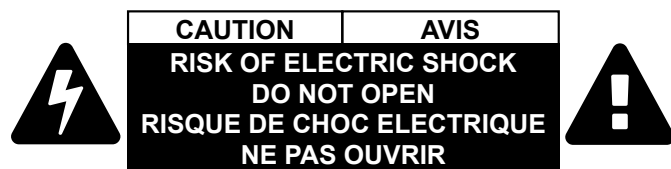

### Ventilation

For the correct ventilation and to avoid overheating, ensure enough free space around the appliance. Do not cover the appliance, leave the ventilation holes free and never block or bypass the ventilators (if there are any).

### WARNING

To prevent injury, the apparatus is recommended to be securely attached to the floor/wall, or mounted in accordance with the installation instructions. The apparatus shall not be exposed to dripping or splashing, and no objects filled with liquids, such as vases, shall be placed on the apparatus. No naked flame sources, such as lit candles, should be placed on the apparatus.

## Waste Electrical & Electronic Equipment WEEE

This marking shown on the product or its literature indicates that it should not be disposed with other household wastes at the end of its working life. To prevent possible harm to the environment or human health from uncontrolled waste disposal, please separate this from other types of wastes and recycle it responsibly to promote the sustainable reuse of material resources. Household users should contact either the retailer where they purchased this product or their local government office for details of where and how they can take this item for environmentally safe recycling. Business users should contact their supplier and check the terms and conditions of the purchase contract. This product should not be mixed with other commercial wastes for disposal.



### CAUTION

The device contains a BR1632A button battery, which supplies power to the clock when the device is not powered on. Danger of explosion if battery is replaced incorrectly. Replace only with the same or equivalent type.

### WARNING

Do not ingest the battery, Chemical Burn Hazard. This product contains a coin/button cell battery. If the coin/button cell battery is swallowed, it can cause severe internal burns in just 2 hours, and can lead to death. Keep new and used batteries away from children. If the battery compartment does not close securely, stop using the product and keep it away from children. If you think batteries might have been swallowed or placed inside any part of the body, seek immediate medical attention.

## Common Safety Symbols

Symbol	Description
	Direct current
	Alternating current
	Double insulation
	Caution, possibility of electric shock
	Caution

## Symbol Legend

The following symbols and markings are used in the document:

**WARNING!** Safety-related information that is highly recommended to read and keep in every case!

**ATTENTION!** Useful information for performing a successful procedure; it is recommended to read.

**DIFFERENCE:** Feature or function that is available with a specific firmware/hardware version or product variant.

**INFO:** A notice, which may contain additional information. Procedure can be successful without reading it.

**DEFINITION:** The short description of a feature or a function.

**TIPS AND TRICKS:** Ideas that you may have not known yet, but can be useful.

## Navigation Buttons

 Go back to the previous page. If you clicked on a link previously, you can go back to the source page by pressing the button.

 Navigate to the Table of Contents.

 Step back one page.

 Step forward to the next page.

## Document Information

All presented functions refer to the indicated products. The descriptions have been made while testing these functions in accordance with the indicated Hardware/Firmware/Software environment:

Item	Version
Lightware Device Controller (LDC) software	2.14.0b3
Lightware Device Updater v2 (LDU2) Software	2.32.0b3
Firmware package (UCX-TPX-TX devices)	1.13.0b3
Firmware package (UCX-TPX-RX devices)	1.3.0b2
Firmware package (HDMI-TPX-RX devices)	2.5.2b1

Document revision: **v1.5**

Release date: **26-11-2024**

Editor: **Nikolett Keindl**

## About Printing

Lightware Visual Engineering supports green technologies and eco-friendly mentality. Thus, this document is made primarily for digital usage. If you need to print out a few pages for any reason, follow the recommended printing settings:

- Page size: A4
- Output size: Fit to page or Match page size
- Orientation: Landscape

**TIPS AND TRICKS:** Thanks to the size of the original page, a border around the content (gray on the second picture below) makes it possible to organize the pages better. After punching holes in the printed pages, they can easily be placed into a ring folder.

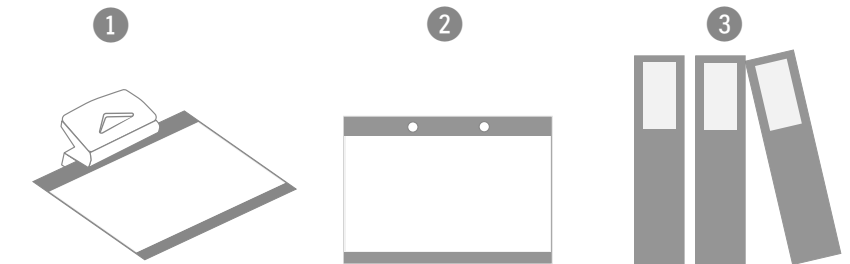

## Hashtag (#) Keywords in the Document

This user's manual contains keywords with hashtags (#) to help you find the relevant information as quick as possible.

The format of the keywords is the following:

#<keyword>

The usage of the keywords: use the **Search** function (Ctrl+F / Cmd+F) of your PDF reader application, type the # (hashtag) character and the wished keyword.

The **#new** special keyword indicates a new feature/function that has just appeared in the latest firmware or software version.

### Example

#dhcp

This keyword is placed at the DHCP setting command in the LW3 Programmer's reference section.

## Table of Contents

<b>1. INTRODUCTION</b> .....	<b>8</b>	<b>4.4. POWER DELIVERY OVER TYPE-C</b> .....	<b>29</b>	<b>6. SOFTWARE CONTROL OPTIONS</b> .....	<b>52</b>
1.1. DESCRIPTION .....	9	4.4.1. Power Data Objects (USB-C).....	29	<b>6.1. SOFTWARE CONTROL MODES</b> .....	<b>52</b>
1.2. BOX CONTENTS .....	10	<b>4.5. USB-C CABLE RECOMMENDATION</b> .....	<b>30</b>	<b>6.2. USING THE BUILT-IN WEB</b> .....	<b>54</b>
1.3. TYPICAL APPLICATION .....	11	<b>4.6. CONNECTING STEPS</b> .....	<b>31</b>	<b>6.3. INSTALL AND UPDATE THE LDC</b> .....	<b>55</b>
1.4. FEATURES OF THE DEVICE.....	12	<b>5. DEVICE CONCEPT</b> .....	<b>32</b>	<b>6.4. RUNNING THE LDC</b> .....	<b>56</b>
<b>2. PRODUCT OVERVIEW</b> .....	<b>13</b>	<b>5.1. UNIVERSAL SWITCHER CONCEPT</b> .....	<b>33</b>	<b>6.5. ESTABLISHING THE CONNECTION</b> .....	<b>56</b>
2.1. UCX-4x3-TPX-TX20 .....	14	<b>5.2. USB INTERFACE</b> .....	<b>33</b>	<b>6.6. BULK DEVICE MANAGEMENT</b> .....	<b>57</b>
2.2. UCX-2x1-TPX-TX20 .....	15	5.2.1. USB-C Interface .....	33	6.6.1. Network Settings .....	57
2.3. UCX-3x3-TPX-RX20 .....	16	5.2.2. USB Data - USB Interface .....	33	6.6.2. Device Configuration.....	58
2.4. HDMI-UCX-TPX-RX107 .....	17	5.2.3. USB Service Ports - USB 2.0 Interface .....	35	<b>6.7. VIDEO &amp; AUDIO CROSSPOINT</b> .....	<b>59</b>
<b>3. FRONT PANEL CONTROL</b> .....	<b>18</b>	<b>5.3. VIDEO INTERFACE</b> .....	<b>35</b>	6.7.1. Port Tiles.....	60
3.1. <b>BUTTON FUNCTIONALITY</b> .....	<b>19</b>	5.3.1. Welcome Screen.....	35	<b>6.8. PORT PROPERTIES WINDOW</b> .....	<b>61</b>
3.1.1. Video Source Selection - UCX-4x3-TPX-TX20.....	19	5.3.2. Video Port Diagrams .....	36	6.8.1. Welcome Screen.....	61
3.1.2. Video Source Selection - UCX-2x1-TPX-TX20.....	19	5.3.3. DisplayPort Alternate Mode.....	36	6.8.2. USB-C Inputs.....	62
3.1.3. Video Source Selection - UCX-3x3-TPX-RX20.....	19	<b>5.4. THE AUTOSELECT FEATURE</b> .....	<b>37</b>	6.8.3. HDMI Video Input .....	63
3.1.4. Enabling DHCP IP Address .....	19	<b>5.5. AUDIO INTERFACE</b> .....	<b>40</b>	6.8.4. HDMI Video Output .....	64
3.1.5. Reset to Factory Default Settings.....	19	5.5.1. Analog Audio Interface .....	40	6.8.5. Embedded Audio Input.....	66
3.1.6. Control Lock.....	20	<b>5.6. ETHERNET INTERFACE</b> .....	<b>40</b>	6.8.6. Analog Audio Output.....	66
3.2. <b>STATUS LEDs</b> .....	<b>20</b>	<b>5.7. LIGHTWARE ADVANCED ROOM AUTOMATION (LARA)</b> .....	<b>42</b>	6.8.7. Frame Detector.....	67
3.2.1. Front Panel LEDs .....	20	5.7.1. Opening the LARA interface .....	42	<b>6.9. CEC TOOL</b> .....	<b>67</b>
3.2.2. Rear Panel LEDs .....	20	5.7.2. Running LARA.....	42	<b>6.10. USB CROSSPOINT</b> .....	<b>68</b>
3.2.3. Ethernet Status LEDs .....	21	5.7.3. Downloading/Uploading a Configuration .....	43	6.10.1. USB-C Port Properties.....	69
3.2.4. TPX Connector LEDs.....	21	5.7.4. Status Board .....	43	6.10.2. USB-B Port Properties.....	70
<b>4. INSTALLATION</b> .....	<b>22</b>	5.7.5. Touch Panel Support.....	43	<b>6.11. EDID MENU</b> .....	<b>71</b>
<b>4.1. MOUNTING OPTIONS</b> .....	<b>23</b>	<b>5.8. BASIC NETWORK SECURITY</b> .....	<b>44</b>	6.11.1. EDID Operations .....	72
4.1.1. 1U High Rack Shelf.....	23	5.8.1. Disable Ethernet Ports .....	44	6.11.2. EDID Summary Window .....	72
4.1.2. Mounting Plate F100.....	23	5.8.2. HTTP/HTTPS.....	44	6.11.3. Editing an EDID .....	73
4.1.3. UD Mounting Plate F110.....	24	5.8.3. Encryption (HTTPS, WSS).....	45	6.11.4. Creating an EDID - Easy EDID Creator .....	73
4.1.4. UD Mounting Pro P210 .....	24	<b>5.9. 802.1x AUTHENTICATION</b> .....	<b>46</b>	<b>6.12. CONTROL MENU</b> .....	<b>74</b>
4.1.5. UD Mounting Pro P110 .....	24	<b>5.10. ADVANCED ETHERNET SECURITY</b> .....	<b>47</b>	6.12.1. Ethernet.....	74
4.1.6. C-Lock .....	24	5.10.1. Network Separation.....	47	6.12.2. GPIO .....	74
<b>4.2. ELECTRICAL CONNECTIONS</b> .....	<b>25</b>	<b>5.11. LIGHTWARE CRYPTO CORE</b> .....	<b>49</b>	6.12.3. OCS - Occupancy Sensor .....	75
4.2.1. HDMI Input and Output Ports .....	25	<b>5.12. WEBSOCKET SERVICE (WS, WSS)</b> .....	<b>49</b>	6.12.4. RS-232.....	75
4.2.2. USB Connectors .....	25	<b>5.13. BULK DEVICE MANAGEMENT</b> .....	<b>49</b>	<b>6.13. SETTINGS MENU</b> .....	<b>76</b>
4.2.3. Analog Stereo Audio .....	25	5.13.1. Network Settings.....	49	6.13.1. TX Status .....	76
4.2.4. TPX Connector.....	25	5.13.2. Device Configuration.....	49	6.13.2. RX Status .....	77
4.2.5. Configurable Ethernet Port .....	26	<b>5.14. SERIAL INTERFACE</b> .....	<b>50</b>	6.13.3. Network.....	77
4.2.6. OCS Connector .....	26	5.14.1. Serial Port Diagram.....	50	6.13.4. Services.....	78
4.2.7. GPIO - General Purpose Input/Output Ports.....	27	<b>5.15. GPIO INTERFACE</b> .....	<b>51</b>	6.13.5. Power .....	80
4.2.8. RS-232 Connector .....	27	<b>5.16. OCS INTERFACE</b> .....	<b>51</b>	6.13.6. System .....	81
<b>4.3. POWERING OPTIONS</b> .....	<b>28</b>	<b>5.17. FURTHER BUILT-IN FEATURES</b> .....	<b>51</b>	<b>6.14. ADVANCED VIEW WINDOW</b> .....	<b>82</b>
		5.17.1. Device Cloning – Configuration Backup and Restore.....	51		

<b>7. LIGHTWARE REST API REFERENCE .....</b>	<b>84</b>	7.6.17. Turning on Output 5V .....	95	7.13.1. Querying the Emulated EDIDs.....	105
<b>7.1. OVERVIEW.....</b>	<b>85</b>	<b>7.7. WELCOME SCREEN SETTINGS.....</b>	<b>95</b>	7.13.2. Querying the Validity of a Dynamic EDID .....	106
<b>7.2. INSTRUCTIONS FOR THE TERMINAL APPLICATION USAGE.....</b>	<b>85</b>	7.7.1. Displaying the Welcome Screen Image .....	95	7.13.3. Querying the Preferred Resolution of a User EDID .....	106
7.2.1. Third-party API Platform .....	85	7.7.2. Displaying the Welcome Screen Text.....	95	7.13.4. Emulating an EDID to an Input Port.....	106
7.2.2. Terminal Application .....	85	7.7.3. Setting the Welcome Screen Text .....	96	7.13.5. Emulating an EDID to All Input Ports .....	106
<b>7.3. PROTOCOL RULES.....</b>	<b>87</b>	7.7.4. Resetting the Welcome Screen Image.....	96	7.13.6. Copying an EDID to User Memory .....	107
7.3.1. Command Structure Example .....	87	<b>7.8. VIDEO PORT SETTINGS - USB-C RELATED COMMANDS.....</b>	<b>96</b>	7.13.7. Deleting an EDID from User Memory .....	107
7.3.2. General Rules.....	87	7.8.1. Restarting the Link Training .....	96	7.13.8. Resetting the Emulated EDIDs.....	107
7.3.3. Legend for the Control Commands.....	87	<b>7.9. CEC COMMAND SENDING .....</b>	<b>96</b>	<b>7.14. ETHERNET PORT CONFIGURATION .....</b>	<b>107</b>
7.3.4. Lightware REST API vs. LW3 Protocol .....	87	7.9.1. Simple CEC Code Sending.....	96	7.14.1. Setting the DHCP State.....	107
7.3.5. Method Types .....	88	7.9.2. Remote Control Code Sending .....	97	7.14.2. Changing the IP Address (Static).....	108
7.3.6. Supported Commands.....	88	<b>7.10. AUDIO PORT SETTINGS.....</b>	<b>97</b>	7.14.3. Changing the Subnet Mask (Static) .....	108
7.3.7. Not Supported Commands.....	88	7.10.1. Switching the Audio Input.....	97	7.14.4. Changing the Gateway Address (Static).....	108
7.3.8. Status Codes, Error Messages .....	88	7.10.2. Querying the Connected Source.....	97	7.14.5. Applying the Network Settings .....	109
7.3.9. Polling .....	88	7.10.3. Querying the Connected Destinations .....	98	7.14.6. Setting the Hostname .....	109
<b>7.4. REST API SECURITY .....</b>	<b>89</b>	7.10.4. Setting the Autoselect Operation Mode.....	98	<b>7.15. NETWORK SECURITY .....</b>	<b>109</b>
7.4.1. Authentication .....	89	7.10.5. Setting the Followed Video Port to Autoselect .....	98	7.15.1. Enabling/Disabling the Ethernet Port.....	109
7.4.2. Encryption (HTTPS).....	89	7.10.6. Locking the Audio Port .....	98	7.15.2. Querying the Network Service Port Number.....	109
<b>7.5. SYSTEM COMMANDS.....</b>	<b>89</b>	7.10.7. Muting the Audio Port 1.....	99	7.15.3. Enabling/Disabling the Network Service Port .....	110
7.5.1. Setting the Device Label .....	89	7.10.8. Muting the Audio Port 2.....	99	7.15.4. Querying the Username for Authentication .....	110
7.5.2. Resetting the Device.....	89	7.10.9. Querying the Audio Signal Presence.....	99	7.15.5. Setting a Password for Authentication.....	110
7.5.3. Restoring the Factory Default Settings.....	89	7.10.10. Analog Audio Output Volume (dB) Setting.....	100	7.15.6. Enabling the Authentication .....	110
7.5.4. Querying the Firmware Package Version.....	90	7.10.11. Analog Audio Output Volume Percent Setting .....	100	7.15.7. Setting the VLAN ID.....	111
7.5.5. Control Lock.....	90	7.10.12. Setting the Balance .....	100	<b>7.16. SERIAL PORT CONFIGURATION .....</b>	<b>111</b>
7.5.6. Setting the Current Time.....	90	7.10.13. Analog Audio Output Level Setting by Steps (dB).....	100	7.16.1. BAUD Rate Setting.....	111
7.5.7. Identifying the Device.....	90	7.10.14. Analog Audio Output Level Setting by Steps in Percent.....	101	7.16.2. Stop Bits Setting.....	111
7.5.8. Toggling the Dark Mode Setting.....	90	7.10.15. Analog Audio Output Balance Setting by Steps .....	101	7.16.3. Querying the Data Bits .....	112
7.5.9. Setting the Delay of the Dark Mode.....	91	<b>7.11. USB PORT SETTINGS .....</b>	<b>101</b>	7.16.4. Parity Setting .....	112
<b>7.6. VIDEO PORT SETTINGS - GENERAL.....</b>	<b>91</b>	7.11.1. Switching the USB Input .....	101	7.16.5. Querying the Serial over IP Port Number .....	112
7.6.1. Switching the Video Input.....	91	7.11.2. Querying the Connected Source.....	101	7.16.6. Enabling the Serial over IP Port.....	112
7.6.2. Switching an Input to All Outputs.....	91	7.11.3. Querying the Connected Destinations .....	102	<b>7.17. SERIAL PORT MESSAGING .....</b>	<b>113</b>
7.6.3. Locking the Video Port.....	92	7.11.4. Locking the USB Port .....	102	7.17.1. Sending a Message via RS-232 .....	113
7.6.4. Muting the Video Port .....	92	7.11.5. Setting the 5V Sending to the USB Peripherals.....	102	<b>7.18. GPIO PORT CONFIGURATION .....</b>	<b>113</b>
7.6.5. Setting the Autoselect Policy.....	92	7.11.6. Setting the USB Autoselect Policy .....	102	7.18.1. Setting the Direction of a GPIO Pin .....	113
7.6.6. Changing the Autoselect-Included Input Ports.....	92	7.11.7. Setting the Followed Video Port to Autoselect .....	103	7.18.2. Setting the Output Level of a GPIO Pin .....	113
7.6.7. Changing the Input Port Priority .....	93	7.11.8. Changing the Autoselect Included USB Ports .....	103	7.18.3. Setting the Output Level for a Specified Time.....	114
7.6.8. Querying the Connected Source.....	93	7.11.9. Changing the USB Port Priority .....	103	7.18.4. Toggling the Level of a GPIO Pin.....	114
7.6.9. Querying the Connected Destinations .....	93	<b>7.12. USB PORT SETTINGS - USB-C RELATED COMMANDS .....</b>	<b>103</b>	<b>7.19. OCS PORT CONFIGURATION.....</b>	<b>114</b>
7.6.10. Querying the Input Switching Capability.....	93	7.12.1. Setting the USB-C Power .....	103	7.19.1. Querying the Input Level of an OCS Pin .....	114
7.6.11. Query the Video Signal Presence .....	93	7.12.2. Setting the Displayport Alternate Mode Policy.....	104	7.19.2. Setting the Sensor Type.....	115
7.6.12. HDCP Setting (Input Port).....	94	7.12.3. Querying the Host Alternate Mode Support .....	104	7.19.3. Querying the Reported OCS State .....	115
7.6.13. HdcpMode .....	94	7.12.4. Querying the Status of the Alternate Mode .....	104	<b>7.20. UPDATING THE DEVICE VIA REST API.....</b>	<b>115</b>
7.6.14. Querying the Embedded Audio Presence .....	94	7.12.5. Querying the Port Data Role .....	105	7.20.1. Querying the Update REST API Version .....	115
7.6.15. Muting the Embedded Audio.....	94	7.12.6. Querying the Port Power Role .....	105	7.20.2. The Updating Process.....	116
7.6.16. Setting the Output Signal Type.....	95	7.12.7. Setting the Port Power Role.....	105	7.20.3. Uploading the Package.....	116
		<b>7.13. EDID MANAGEMENT .....</b>	<b>105</b>	7.20.4. Configuration Parameters – Keep the Current Settings .....	117

7.20.5. Executing the Update .....	117	8.6.17. Output5VMode .....	133	8.12.7. Querying the Port Power Role .....	145
7.20.6. Querying the State of the Updating Process .....	118	8.6.18. HDCP Capability (Output Port) .....	134	8.12.8. Setting the Port Power Role.....	145
<b>7.21. LIGHTWARE REST API QUICK SUMMARY.....</b>	<b>119</b>	8.6.19. HDCP Setting (Output Port).....	134	<b>8.13. EDID MANAGEMENT .....</b>	<b>145</b>
<b>8. LW3 PROGRAMMERS' REFERENCE .....</b>	<b>124</b>	<b>8.7. WELCOME SCREEN SETTINGS.....</b>	<b>134</b>	8.13.1. Querying the Emulated EDIDs.....	145
<b>8.1. OVERVIEW.....</b>	<b>125</b>	8.7.1. Displaying the Welcome Screen Image .....	134	8.13.2. Querying the Validity of a Dynamic EDID .....	145
<b>8.2. INSTRUCTIONS FOR THE TERMINAL APPLICATION USAGE.....</b>	<b>125</b>	8.7.2. Displaying the Welcome Screen Text.....	134	8.13.3. Querying the Preferred Resolution of a User EDID .....	146
<b>8.3. WEBSOCKET (WS) OR SECURED WEBSOCKET (WSS) USAGE.....</b>	<b>125</b>	8.7.3. Setting the Welcome Screen Text .....	135	8.13.4. Emulating an EDID to an Input Port.....	146
<b>8.4. PROTOCOL RULES.....</b>	<b>126</b>	8.7.4. Resetting the Welcome Screen Image.....	135	8.13.5. Emulating an EDID to All Input Ports .....	146
8.4.1. LW3 Tree Structure and Command Structure (examples) .....	126	<b>8.8. VIDEO PORT SETTINGS - USB-C RELATED COMMANDS.....</b>	<b>135</b>	8.13.6. Copying an EDID to User Memory .....	146
8.4.2. General Rules.....	126	8.8.1. Restarting the Link Training .....	135	8.13.7. Deleting an EDID from User Memory .....	146
8.4.3. Legend for the Control Commands.....	126	<b>8.9. CEC COMMAND SENDING .....</b>	<b>136</b>	8.13.8. Resetting the Emulated EDIDs.....	147
8.4.4. Command Types .....	127	8.9.1. Simple CEC Code Sending .....	136	<b>8.14. ETHERNET PORT CONFIGURATION .....</b>	<b>147</b>
8.4.5. Prefix Summary .....	127	8.9.2. Remote Control Code Sending .....	136	8.14.1. Setting the DHCP State.....	147
8.4.6. Error Messages .....	127	<b>8.10. AUDIO PORT SETTINGS.....</b>	<b>138</b>	8.14.2. Changing the IP Address (Static).....	147
8.4.7. Escaping .....	127	8.10.1. Switching the Audio Input.....	138	8.14.3. Changing the Subnet Mask (Static) .....	148
8.4.8. Signature.....	128	8.10.2. Querying the Connected Source.....	138	8.14.4. Changing the Gateway Address (Static).....	148
8.4.9. Subscription.....	128	8.10.3. Querying the Connected Destinations .....	138	8.14.5. Applying the Network Settings .....	148
8.4.10. Notifications about the Changes of the Properties .....	128	8.10.4. Setting the Autoselect Operation Mode.....	138	8.14.6. Setting the Host name .....	148
<b>8.5. SYSTEM COMMANDS.....</b>	<b>129</b>	8.10.5. Setting the Followed Video Port to Autoselect .....	138	<b>8.15. REMOTE POWER .....</b>	<b>148</b>
8.5.1. Setting the Device Label .....	129	8.10.6. Locking the Audio Port .....	139	8.15.1. Enabling/Disabling Remote Power .....	148
8.5.2. Resetting the Device.....	129	8.10.7. Muting the Audio Port 1.....	139	<b>8.16. NETWORK SECURITY .....</b>	<b>149</b>
8.5.3. Restoring the Factory Default Settings .....	129	8.10.8. Muting the Audio Port 2.....	139	8.16.1. Enabling/Disabling the Ethernet Port.....	149
8.5.4. Querying the Firmware Package Version.....	129	8.10.9. Querying the Audio Signal Presence.....	139	8.16.2. Querying the Service Port Number.....	149
8.5.5. Control Lock.....	129	8.10.10. Analog Audio Output Volume (dB) Setting .....	140	8.16.3. Enabling/Disabling the Service Port .....	149
8.5.6. Setting the Current Time.....	129	8.10.11. Analog Audio Output Volume Percent Setting .....	140	8.16.4. Querying the Username for Authentication .....	149
8.5.7. Identifying the Device.....	130	8.10.12. Setting the Balance .....	140	8.16.5. Enabling the Authentication .....	150
8.5.8. Toggling the Dark Mode Setting.....	130	8.10.13. Analog Audio Output Level Setting by Steps (dB).....	140	8.16.6. Restating the Network Services.....	150
8.5.9. Setting the Delay of the Dark Mode Setting.....	130	8.10.14. Analog Audio Output Level Setting by Steps in Percent.....	140	8.16.7. Setting the VLAN ID.....	150
<b>8.6. VIDEO PORT SETTINGS - GENERAL.....</b>	<b>130</b>	8.10.15. Analog Audio Output Balance Setting by Steps .....	140	<b>8.17. SERIAL PORT CONFIGURATION .....</b>	<b>151</b>
8.6.1. Switching Video Input .....	130	<b>8.11. USB PORT SETTINGS .....</b>	<b>141</b>	8.17.1. BAUD Rate Setting.....	151
8.6.2. Switching an Input to All Outputs.....	130	8.11.1. Switching the USB Input .....	141	8.17.2. Stop Bits Setting.....	151
8.6.3. Locking the Video Port.....	131	8.11.2. Querying the Connected Source.....	141	8.17.3. Querying the Data Bits .....	151
8.6.4. Muting the Video Port .....	131	8.11.3. Querying the Connected Destinations .....	141	8.17.4. Parity Setting .....	151
8.6.5. Setting the Autoselect Policy.....	131	8.11.4. Locking the USB Port .....	141	<b>8.18. SENDING A MESSAGE VIA RS-232 .....</b>	<b>151</b>
8.6.6. Changing the Autoselect Included Input Ports.....	131	8.11.5. Setting the 5V Sending to the USB Peripherals.....	142	<b>8.19. GPIO PORT CONFIGURATION .....</b>	<b>152</b>
8.6.7. Changing the Input Port Priority .....	132	8.11.6. Setting the USB Autoselect Policy .....	142	8.19.1. Querying the Direction of a GPIO Pin .....	152
8.6.8. Querying the Connected Source.....	132	8.11.7. Setting the Followed Video Port to Autoselect .....	142	8.19.2. Setting the Direction of a GPIO Pin .....	152
8.6.9. Querying the Input Switching Capability .....	132	8.11.8. Changing the Autoselect Included USB Ports .....	143	8.19.3. Querying the Output Level of a GPIO Pin .....	152
8.6.10. Querying the Connected Destinations .....	132	8.11.9. Changing the USB Port Priority .....	143	8.19.4. Setting the Output Level of a GPIO Pin .....	152
8.6.11. Querying the Video Signal Presence .....	132	<b>8.12. USB PORT SETTINGS - USB-C RELATED COMMANDS .....</b>	<b>143</b>	8.19.5. Setting the Output Level for a Specified Time.....	152
8.6.12. HDCP Setting (Input Port).....	132	8.12.1. Setting the USB-C Power .....	143	8.19.6. Toggling the Level of a GPIO Pin.....	152
8.6.13. HdcpMode .....	133	8.12.2. Setting the Power Allocation Mode .....	143	<b>8.20. OCS PORT CONFIGURATION.....</b>	<b>153</b>
8.6.14. OutputSignalType.....	133	8.12.3. Setting the Displayport Alternate Mode Policy.....	144	8.20.1. Querying the Input Level of an OCS Pin .....	153
8.6.15. EmbeddedAudioPresent.....	133	8.12.4. Querying the Host Alternate Mode Support .....	144	8.20.2. Setting the Sensor Type.....	153
8.6.16. EmbeddedAudioMute .....	133	8.12.5. Querying the Status of the Alternate Mode .....	144		
		8.12.6. Querying the Port Data Role .....	144		

8.20.3. Querying the Reported OCS State .....	153
<b>8.21. LW3 COMMANDS - QUICK SUMMARY .....</b>	<b>154</b>
<b>9. FIRMWARE UPDATE.....</b>	<b>158</b>
<b>9.1. INTRODUCTION .....</b>	<b>159</b>
<b>9.2. PREPARATION .....</b>	<b>159</b>
9.2.1. About the Firmware Package (LFP2 File) .....	159
9.2.2. LDU2 Installation .....	159
<b>9.3. RUNNING THE SOFTWARE .....</b>	<b>160</b>
<b>9.4. UPDATING VIA GUI .....</b>	<b>161</b>
<b>10. TROUBLESHOOTING .....</b>	<b>163</b>
<b>10.1. USE CASE STUDIES .....</b>	<b>164</b>
<b>10.2. HOW TO SPEED UP THE TROUBLESHOOTING PROCESS .....</b>	<b>165</b>
<b>11. TECHNOLOGIES .....</b>	<b>166</b>
<b>11.1. EDID MANAGEMENT .....</b>	<b>167</b>
11.1.1. Understanding the EDID.....	167
11.1.2. Advanced EDID Management.....	167
<b>11.2. HDCP MANAGEMENT .....</b>	<b>168</b>
11.2.1. Protected and Unprotected Content .....	168
11.2.2. Disable Unnecessary Encryption.....	168
11.2.3. HDCP 2.2.....	169
<b>11.3. PIXEL ACCURATE RECLOCKING .....</b>	<b>170</b>
<b>12. APPENDIX .....</b>	<b>171</b>
<b>12.1. SPECIFICATIONS .....</b>	<b>172</b>
12.1.1. UCX-4x3-TPX-TX20, UCX-2x1-TPX-TX20, UCX-3x3-TPX-RX20 .	172
12.1.2. HDMI-UCX-TPX-RX107 .....	174
<b>12.2. PORT NUMBERING .....</b>	<b>176</b>
<b>12.3. APPLIED PORTS (NETWORK SETTINGS).....</b>	<b>176</b>
<b>12.5. FACTORY EDID LIST.....</b>	<b>177</b>
<b>12.6. CABLE WIRING GUIDE.....</b>	<b>179</b>
12.6.1. Serial Ports .....	179
12.6.2. Audio Ports .....	179
<b>12.7. FACTORY DEFAULT SETTINGS.....</b>	<b>180</b>
<b>12.8. CONTENT OF THE BACKUP FILE .....</b>	<b>181</b>
<b>12.9. MECHANICAL DRAWINGS .....</b>	<b>182</b>
<b>12.10. FIRMWARE RELEASE NOTES FOR UCX-TX DEVICES.....</b>	<b>184</b>
<b>12.11. FIRMWARE RELEASE NOTES FOR UCX-TPX-RX DEVICES .....</b>	<b>186</b>
<b>12.12. FIRMWARE RELEASE NOTES FOR HDMI-TPX-RX DEVICES .....</b>	<b>186</b>
<b>12.13. HASHTAG KEYWORD LIST .....</b>	<b>188</b>
<b>12.14. FURTHER INFORMATION.....</b>	<b>189</b>

# 1

## Introduction

Thank You for choosing Lightware's UCX-TPX series device. In the first chapter we would like to introduce the device, highlighting the most important features in the sections listed below:

- ▶ [DESCRIPTION](#)
- ▶ [BOX CONTENTS](#)
- ▶ [TYPICAL APPLICATION](#)
- ▶ [FEATURES OF THE DEVICE](#)



### 1.1. Description

Lightware’s universal matrix switcher Transmitter exploits the USB-C connectivity for a simplified extension of up to 100m of 4K video, audio, control signals and power, providing meeting participants with easy host switching, video resolution capabilities up to 4K@60Hz at 4:4:4, as well as comprehensive and secure Ethernet features.

The Receiver extender with AVX technology allows users to extend HDMI 2.0 signals up to 4K60 4:4:4 video resolution through a single CATx cable over distances of up to 100 meters. They also support independent USB host switching with USB 2.0, making the pair excellent for meeting room setups.

The Transmitter / Receiver pair is featured with audio de-embedding function via the 5-pole Phoenix® Combicon analog audio ports.

Beyond the benefits of sending high-resolution video over long distances, the pair is also capable of handling various connectivity standards, including bi-directional RS-232, GPIO and OCS as well.

The Gigabit Ethernet port is also a valuable addition, allowing users to connect an additional device to the network directly through the TPX extender.

The Transmitter is also capable of powering the HDMI-UCX-TPX-RX107 Receiver remotely over Ethernet, as the Receiver is PoE compatible.

UCX-3x3-TPX-RX20 model is compatible with all transmitters in the UCX-TPX family.

### Model Denomination

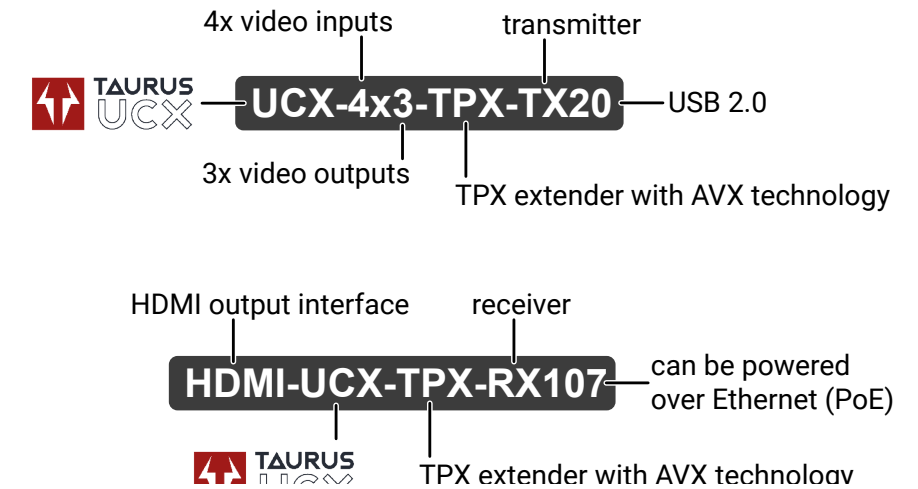



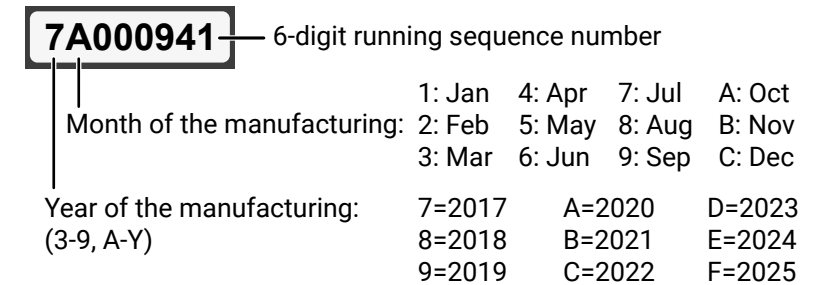

### About the Serial Number

Lightware devices contain a label indicating the unique serial number of the product. The structure is the following:

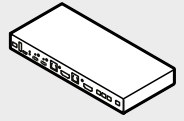
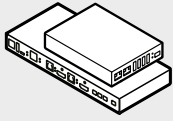
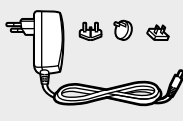
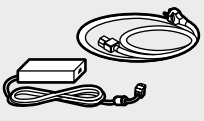
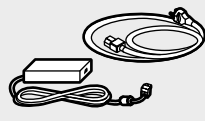
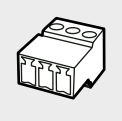

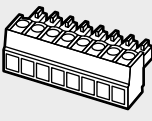
## 1.2. Box Contents

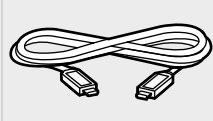
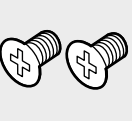
	Supplied Accessories											
												
	Transmitter device	Receiver device	12V DC adaptor with interchangeable plugs	24V power adaptor with IEC power cable	12V power adaptor with IEC power cable	Phoenix® Combicon 3-pole male Connector	Phoenix® Combicon 3-pole Connector	Phoenix® Combicon 5-pole Connector	Phoenix® Combicon 8-pole Connector	Safety and Warranty Info, QSG	Type C (USB-C) to Type C (USB-C) Cable, 1m	2 pcs. of M3x4 flat head screw
UCX-4x3-TPX-TX20	✓	✗	✗	✓	✗	✗	2x	✓	✓	✓	✓	✓
UCX-2x1-TPX-TX20	✓	✗	✗	✓	✗	✗	✓	✓	✓	✓	✓	✓
UCX-3x3-TPX-RX20	✗	✓	✗	✗	✓	✓	✓	✓	✓	✓	✗	✓
HDMI-UCX-TPX-RX107	✗	✓	✓	✗	✗	✓	✓	✓	✗	✓	✗	✓

INFO: The -LCC models have the same values as non-LCC models.

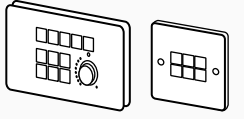
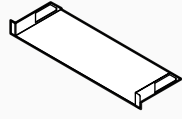
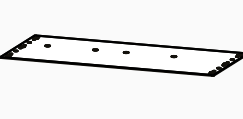
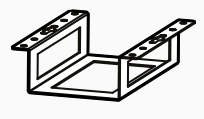
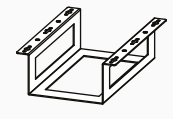
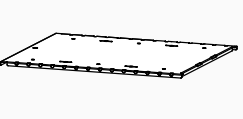
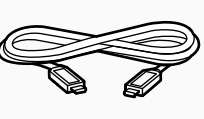
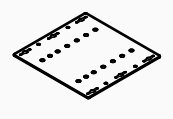
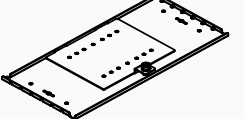
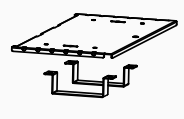
	Optional accessories									
										
	Button panels: RAP-B511 and TBP6	Rack shelf	UD mounting plate F100	UD Mounting PSU F100	UD Mounting PSU F120	UD Mounting Pro P210	Type-C (USB-C) to Type-C (USB-C) Cable, 2m	UD mounting plate F110	UD mounting Pro P110	UD mounting Pro120
UCX-4x3-TPX-TX20	✓	✓	✓	✗	✓	✓	✓	✗	✗	✗
UCX-2x1-TPX-TX20	✓	✓	✓	✓	✗	✓	✓	✗	✗	✓
UCX-3x3-TPX-RX20	✓	✓	✓	✗	✗	✓	✗	✗	✗	✗
HDMI-UCX-TPX-RX107	✗	✓	✗	✗	✗	✗	✗	✓	✓	✗

INFO: The -LCC models have the same values as non-LCC models.

### 1.3. Typical Application

INFO: UCX-3x3-TPX-RX20 model is compatible with all transmitters in the UCX-TPX family.

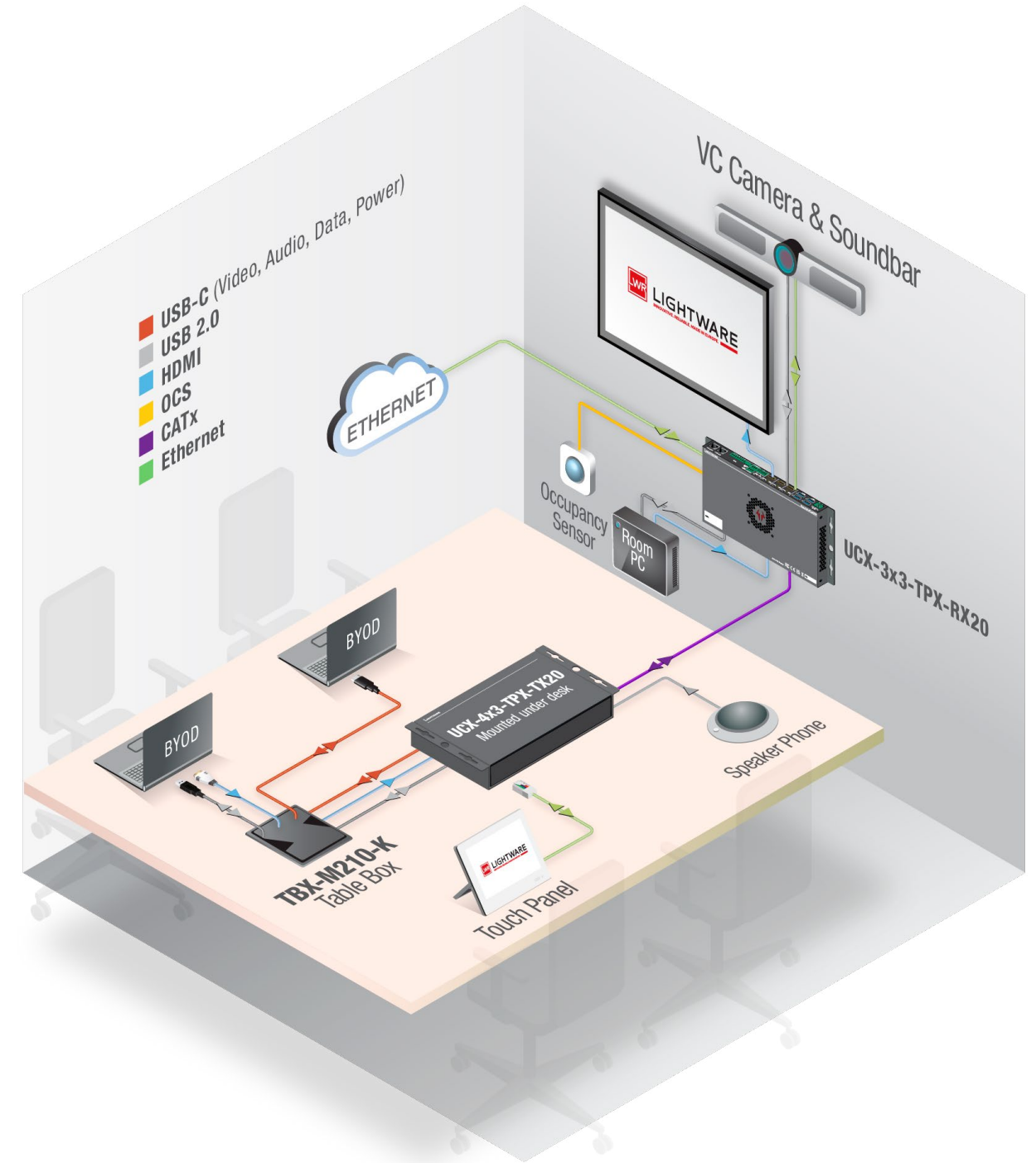
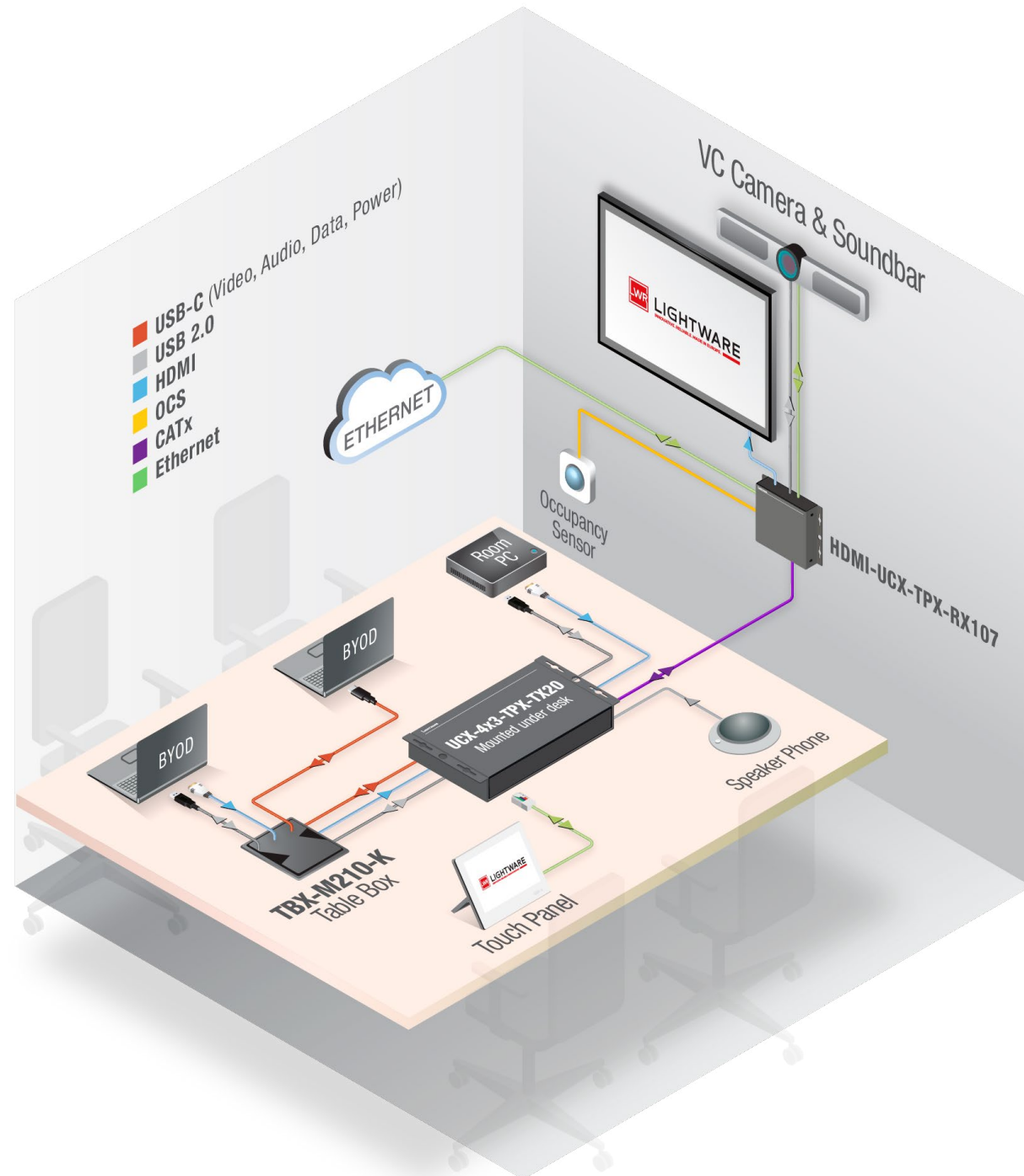

## 1.4. Features of the Device



### 3D and 4K Support

High bandwidth allows extension of resolutions up to 4K and even 3D sources and displays are supported.



### Pixel Accurate Reclocking

Each output has a clean, jitter free signal, eliminating signal instability and distortion caused by long cables or connector reflections.



### Frame Detector and Signal Analysis

The exact video and audio signal format can be determined such as timing, frequencies, scan mode, HDCP encryption, color range, color space and audio sample rate.



### Autoselect Function for Video and USB Inputs

The Autoselect feature can sense the port status on the video input and USB Host ports and select them automatically. Priority number can be set for each input port, and the feature allows to set various modes for the automatic input selection (First detect, Last detect).



### De-embedder Function

The analog audio can be de-embedded from HDMI inputs and it can be routed to the analog audio output.



### HDCP-compliant

The devices fulfill the HDCP standard. HDCP capability on the digital video inputs can be disabled when non-protected content is used.



### Dark Mode

All illuminating elements of the front/rear panel can be switched on and off. This feature is useful in live-stage shows or other environments where flashing LEDs would be distracting.

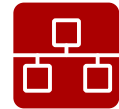

### Ethernet Control

Multiple simultaneous TCP/IP connections are available with a simple ASCII-based protocol for controlling or configuring the product, or to perform a firmware update.



### Basic IT-security

These entry-level network security improvements help prevent unauthorized access to the Lightware device; HTTPS/WSS support, basic network authentication.



### Bi-directional RS-232

AV systems can also contain serial port controllers and controlled devices. Serial transmission supports any unit that works with standard RS-232.



### GPIO Control Port

Six GPIO pins operating at TTL digital signal levels that can be controlled with LW3 commands. 5V is supplied over the 7th pin constantly, up to 500 mA.



### USB 2.0 Switch

The USB 2.0 layer provides switching four external USB peripherals (e.g. webcam, speakerphone, multitouch display, etc.) to four independent host computers or laptops.



### Lightware Rest API

The UCX matrix switcher extenders can be controlled through standard HTTP(S) requests to ensure the control functions from REST clients or terminal program.



### USB Type C Source Connection

USB Type C port ensures USB-C connectivity to the source device with USB 2.0 data and Displayport Alternate mode for video. It provides power delivery of up to 100 W for the first connected device (e.g. BYOD laptop or smartphone).



### Powered by LARA

Future-proof room automation platform for system integrators so they can seamlessly and invisibly support people's collaboration to make the most out of their virtual or in-person meetings.



### Remote Power (PoE)

The Transmitters can provide power over Ethernet (according to IEEE 802.3at) to the HDMI-UCX-TPX-RX107 via the TPX ports.

## UCX-3x3-TPX-RX20



### Occupancy Sensor Connector

Occupancy sensor connection (with 24V power supply).



### USB 3.1 Switch

The USB 3.1 layer provides switching four external USB peripherals (e.g. webcam, speakerphone, multitouch display, etc.) to four independent host computers or laptops.

## All -LCC variants (e.g. UCX-4x3-TPX-TX20-LCC) *#new*

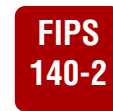

### FIPS 140-2 Validation

Lightware Crypto Core delivers core cryptographic functions to the embedded systems of UCX series' hardware devices and features robust algorithm support.

# 2

## Product Overview

The following sections are about the physical structure of the devices, input/output ports and connectors:

- ▶ [UCX-4x3-TPX-TX20](#)
- ▶ [UCX-2x1-TPX-TX20](#)
- ▶ [UCX-3x3-TPX-RX20](#)
- ▶ [HDMI-UCX-TPX-RX107](#)

## 2.1. UCX-4x3-TPX-TX20

Front view



- |    |                                   |  |
|----|-----------------------------------|--|
| 1  | <b>Configurable Ethernet Port</b> | RJ45 connector for configurable 1GBase-T Ethernet communication.   |
| 2  | <b>USB-A Port</b>                 | The SERVICE-labelled USB-A connector is designed for service functions.  |
| 3  | <b>USB mini-B Port</b>            | The SERVICE-labelled USB mini-B port is designed for service functions.  |
| 4  | <b>LIVE LED</b>                   | See the details in the <a href="#">Front Panel LEDs</a> section.   |
| 5  | <b>RX LED</b>                     | The function will be implemented in a later firmware update.   |
| 6  | <b>USB-C Ports</b>                | USB-C ports for receiving video and audio signals, as well as USB data from the host device.   |
| 7  | <b>Status LEDs</b>                | See the details in the <a href="#">Front Panel LEDs</a> section.   |
| 8  | <b>USB-B Ports</b>                | Upstream ports for connecting USB host devices (e.g. computer).  |
| 9  | <b>Status LEDs</b>                | See the details in the <a href="#">Front Panel LEDs</a> section.   |
| 10 | <b>HDMI Input Ports</b>           | HDMI input ports for sources. The applied cable shall not be longer than 5m. Use cables certified for HDMI 2.0 (3x6Gbps) applications.   |
| 11 | <b>Input Selection Buttons</b>    | For more details, see the <a href="#">Button Functionality</a> section. When LEDs blink green three times after pressing any button, they show that the front panel lock is enabled. |

Rear view



- |   |                                    |   |
|---|------------------------------------|---|
| 1 | <b>DC Input</b>                    | DC input for local powering. Connect the output to the 2-pole Phoenix® connector.   |
| 2 | <b>USB-A Ports</b>                 | Downstream ports for connecting USB peripherals (e.g. camera, keyboard, multitouch display).  |
| 3 | <b>TPX Output Port</b>             | RJ45 port for AVX output signal transmission.   |
| 4 | <b>HDMI Output Ports</b>           | Local HDMI output ports for sending video and audio signals to the sinks (e.g. monitor) connected to the device.  |
| 5 | <b>Status LEDs</b>                 | See the details in the <a href="#">Rear Panel LEDs</a> section.   |
| 6 | <b>Analog Audio Output Port</b>    | Audio output port (5-pole Phoenix®) for balanced analog audio output signal. The signal is de-embedded from the selected video signal.                      |
| 7 | <b>RS-232 Ports</b>                | 3-pole Phoenix® connectors for bi-directional RS-232 communication.   |
| 8 | <b>GPIO port</b>                   | 8-pole Phoenix® connector for configurable general purpose. Max. input/output voltage is 5V, see the details in the <a href="#">GPIO Interface</a> section. |
| 9 | <b>Configurable Ethernet Ports</b> | RJ45 connectors for configurable 1GBase-T Ethernet communication.   |

**WARNING! Always use the supplied power supply! Use of any other power supplies may lead to damage! Warranty void if damage occurs due to using a different power source.**

**INFO:** The -LCC models have the same physical attributes as non-LCC models.

## 2.2. UCX-2x1-TPX-TX20

### Front view

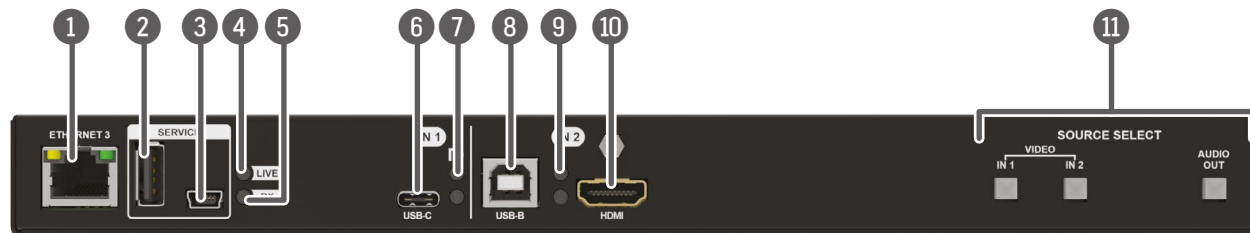

- |           |                                   |  |
|-----------|-----------------------------------|--|
| <b>1</b>  | <b>Configurable Ethernet Port</b> | RJ45 connector for configurable 1GBase-T Ethernet communication.   |
| <b>2</b>  | <b>USB-A Port</b>                 | The SERVICE-labelled USB-A connector is designed for service functions.  |
| <b>3</b>  | <b>USB mini-B Port</b>            | The SERVICE-labelled USB mini-B port is designed for service functions.  |
| <b>4</b>  | <b>LIVE LED</b>                   | See the details in the <a href="#">Front Panel LEDs</a> section.   |
| <b>5</b>  | <b>RX LED</b>                     | The function will be implemented in a later firmware update.   |
| <b>6</b>  | <b>USB-C Port</b>                 | USB-C port for receiving video and audio signals, as well as USB data from the host device.  |
| <b>7</b>  | <b>Status LEDs</b>                | See the details in the <a href="#">Front Panel LEDs</a> section.   |
| <b>8</b>  | <b>USB-B Port</b>                 | Upstream port for connecting USB host devices (e.g. computer).   |
| <b>9</b>  | <b>Status LEDs</b>                | See the details in the <a href="#">Front Panel LEDs</a> section.   |
| <b>10</b> | <b>HDMI Input Port</b>            | HDMI input port for sources. The applied cable shall not be longer than 5m. Use cables certified for HDMI 2.0 (3x6Gbps) applications.  |
| <b>11</b> | <b>Input Selection Buttons</b>    | For more details, see the <a href="#">Button Functionality</a> section. When LEDs blink green three times after pressing any button, they show that the front panel lock is enabled. |

### Rear view



- |          |                                    |   |
|----------|------------------------------------|---|
| <b>1</b> | <b>DC Input</b>                    | DC input for local powering. Connect the output to the 2-pole Phoenix® connector.   |
| <b>2</b> | <b>USB-A Ports</b>                 | Downstream ports for connecting USB peripherals (e.g. camera, keyboard, multitouch display).  |
| <b>3</b> | <b>TPX Output Port</b>             | RJ45 port for AVX output signal transmission.   |
| <b>4</b> | <b>Analog Audio Output Port</b>    | Audio output port (5-pole Phoenix®) for balanced analog audio output signal. The signal is de-embedded from the selected video signal.                      |
| <b>5</b> | <b>RS-232 Port</b>                 | 3-pole Phoenix® connector for bi-directional RS-232 communication.  |
| <b>6</b> | <b>GPIO port</b>                   | 8-pole Phoenix® connector for configurable general purpose. Max. input/output voltage is 5V, see the details in the <a href="#">GPIO Interface</a> section. |
| <b>7</b> | <b>Configurable Ethernet Ports</b> | RJ45 connectors for configurable 1GBase-T Ethernet communication.   |

**WARNING! Always use the supplied power supply! Use of any other power supplies may lead to damage! Warranty void if damage occurs due to using a different power source.**

**INFO:** The -LCC models have the same physical attributes as non-LCC models.

## 2.3. UCX-3x3-TPX-RX20

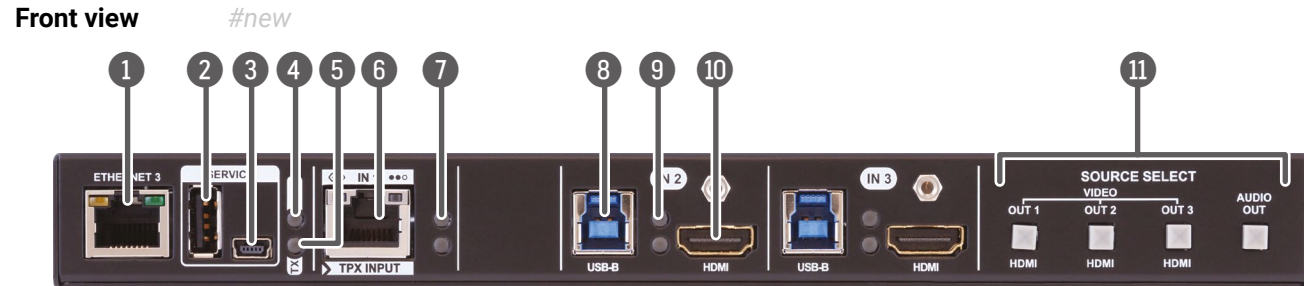

- |    |                                   |  |
|----|-----------------------------------|--|
| 1  | <b>Configurable Ethernet Port</b> | RJ45 connector for configurable 1GBase-T Ethernet communication.   |
| 2  | <b>USB-A Port</b>                 | The SERVICE-labelled USB-A connector is designed for service functions.  |
| 3  | <b>USB mini-B Port</b>            | The SERVICE-labelled USB mini-B port is designed for service functions.  |
| 4  | <b>LIVE LED</b>                   | See the details in the <a href="#">Front Panel LEDs</a> section.   |
| 5  | <b>TX LED</b>                     | The function will be implemented in a later firmware update.   |
| 6  | <b>TPX Input Port</b>             | RJ45 connector for AVX input signal transmission.  |
| 7  | <b>Status LEDs</b>                | See the details in the <a href="#">Front Panel LEDs</a> section.   |
| 8  | <b>USB-B Ports</b>                | Upstream ports for connecting USB host devices (e.g. computer).  |
| 9  | <b>Status LEDs</b>                | See the details in the <a href="#">Front Panel LEDs</a> section.   |
| 10 | <b>HDMI Input Ports</b>           | HDMI input ports for sources. The applied cable shall not be longer than 5m. Use cables certified for HDMI 2.0 (3x6Gbps) applications.   |
| 11 | <b>Input Selection Buttons</b>    | For more details, see the <a href="#">Button Functionality</a> section. When LEDs blink green three times after pressing any button, they show that the front panel lock is enabled. |

### Rear view

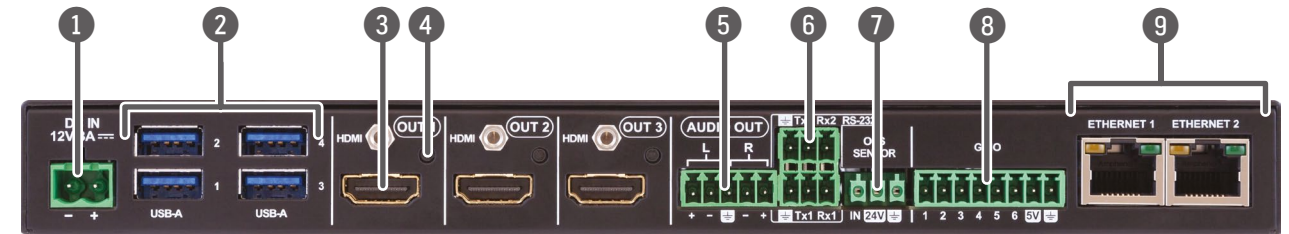

- |   |                                    |   |
|---|------------------------------------|---|
| 1 | <b>DC Input</b>                    | DC input for local powering. Connect the output to the 2-pole Phoenix® connector.   |
| 2 | <b>USB-A Ports</b>                 | Downstream ports for connecting USB peripherals (e.g. camera, keyboard, multitouch display).  |
| 3 | <b>HDMI Output Ports</b>           | Local HDMI output ports for sending video and audio signals to the sinks (e.g. monitor) connected to the device.  |
| 4 | <b>Status LEDs</b>                 | See the details in the <a href="#">Rear Panel LEDs</a> section.   |
| 5 | <b>Analog Audio Output Port</b>    | Audio output port (5-pole Phoenix®) for balanced analog audio output signal. The signal is de-embedded from the selected video signal.                      |
| 6 | <b>RS-232 Ports</b>                | 3-pole Phoenix® connectors for bi-directional RS-232 communication.   |
| 7 | <b>OCS Port</b>                    | 3-pole Phoenix® connector (male) for connecting an occupancy sensor. The port provides 24V output voltage (50mA).   |
| 8 | <b>GPIO port</b>                   | 8-pole Phoenix® connector for configurable general purpose. Max. input/output voltage is 5V, see the details in the <a href="#">GPIO Interface</a> section. |
| 9 | <b>Configurable Ethernet Ports</b> | RJ45 connectors for configurable 1GBase-T Ethernet communication.   |

**WARNING! Always use the supplied power supply! Use of any other power supplies may lead to damage! Warranty void if damage occurs due to using a different power source.**

**INFO:** The -LCC models have the same physical attributes as non-LCC models.



## 2.4. HDMI-UCX-TPX-RX107

### Front view

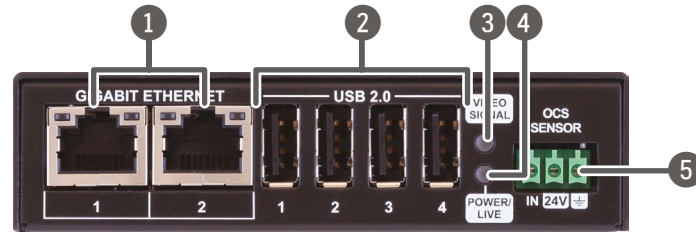

- ① **Gigabit Ethernet Ports** 1GBase-T RJ45 connectors for user Ethernet purpose.
- ② **USB-A Ports** Downstream ports for connecting USB peripherals (e.g. camera, keyboard, multitouch display).
- ③ **Video Signal LED** See the details in the [Front Panel LEDs](#) section.
- ④ **Power/LIVE LED** See the details in the [Front Panel LEDs](#) section.
- ⑤ **OCS sensor** 3-pole Phoenix® connector (male) for connecting an occupancy sensor. The port provides 24V output voltage (50mA).

### Rear view

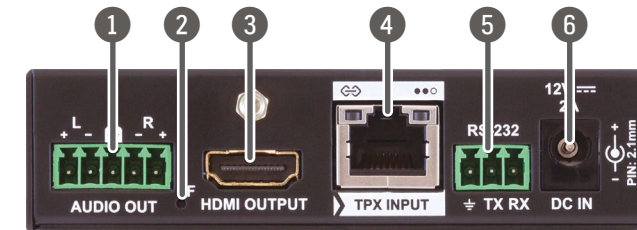

- ① **Analog Audio Output Port** Audio output port (5-pole Phoenix®) for balanced analog audio output signal. The signal is de-embedded from the selected video signal.
- ② **Factory Reset Button** Hidden button for setting the device to factory default values.
- ③ **HDMI Output Port** HDMI output port for connecting sink devices (e.g. displays).
- ④ **TPX Input Port** RJ45 connector for AVX input signal transmission.
- ⑤ **RS-232 Port** 3-pole Phoenix® connector for bi-directional RS-232 communication.
- ⑥ **DC Input** DC input for local powering.

**WARNING! Always use the supplied power supply! Use of any other power supplies may lead to damage. Warranty void if damage occurs due to using a different power source.**

**ATTENTION!** The local powering is only necessary if the device is **not** being powered over Ethernet by the UXC-TPX Transmitter device.

# 3

## Front Panel Control

The following sections are about the front panel operation of the devices and the status LEDs:

- ▶ [BUTTON FUNCTIONALITY](#)
- ▶ [STATUS LEDs](#)

### 3.1. Button Functionality

- INFO: If the control lock is enabled and a button is pressed, front panel LEDs blink 3 times quickly.
- INFO: The -LCC models have the same values as non-LCC models.
- **DIFFERENCE:** HDMI-UCX-TPX-RX107 does not have front panel buttons.

#### 3.1.1. Video Source Selection - UCX-4x3-TPX-TX20

- Push **TPX (1)** to select the video input for the TPX OUT1 port.
- Push **HDMI (2)** to select the video input for the HDMI OUT2 port.
- Push **HDMI (3)** to select the video input for the HDMI OUT3 port.
- Push **AUDIO OUT** to set the audio source of the analog audio output.

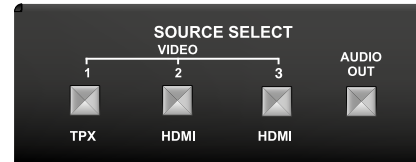

The sequence is the following (both for the video and audio switching): `#switch #crosspoint`

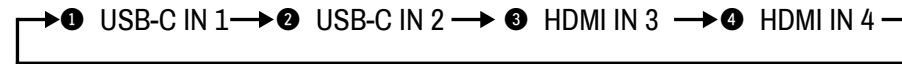

#### 3.1.2. Video Source Selection - UCX-2x1-TPX-TX20

- Push **IN 1** to select the USB-C port as input for the TPX output port.
- Push **IN 2** to select the HDMI port as input for the TPX output port.
- Push **AUDIO OUT** to set the audio source of the analog audio output.

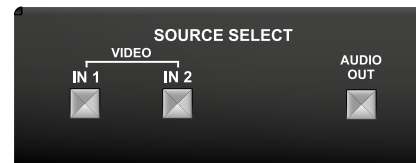

The sequence is the following for the video switching: `#switch #crosspoint`

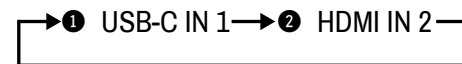

#### 3.1.3. Video Source Selection - UCX-3x3-TPX-RX20

- Push **HDMI (1)** to select the video input for the HDMI OUT1 port.
- Push **HDMI (2)** to select the video input for the HDMI OUT2 port.
- Push **HDMI (3)** to select the video input for the HDMI OUT3 port.
- Push **AUDIO OUT** to set the audio source of the analog audio output.

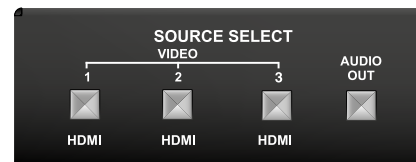

The sequence is the following (both for the video and audio switching): `#switch #crosspoint #new`



#### 3.1.4. Enabling DHCP IP Address

The device has a dynamic IP address as a factory default setting. If it is set to static IP address during install or usage, dynamic IP address can be enabled from the front panel:

- Step 1.** Make sure the device is powered on and operational.
- Step 2.** Press and keep pressing the **AUDIO OUT** button for 5 seconds.

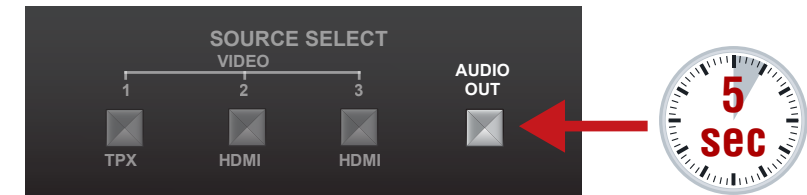

- Step 3.** After 5 seconds the front panel LEDs start blinking; release the button and press it 3 times again quickly (within 3 seconds).

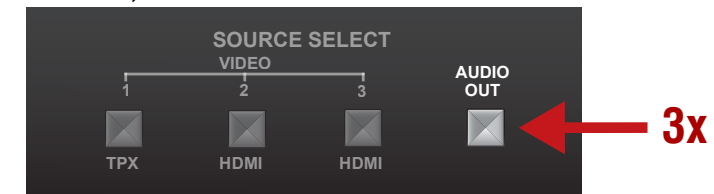

- Step 4.** The LEDs get dark, DHCP gets enabled. `#dhcp`

#### 3.1.5. Reset to Factory Default Settings

To restore factory default values, do the following steps: `#factory`  
Make sure the device is powered on and operational.

- Step 1.** Press and keep pressing the **AUDIO OUT** button for 10 seconds.

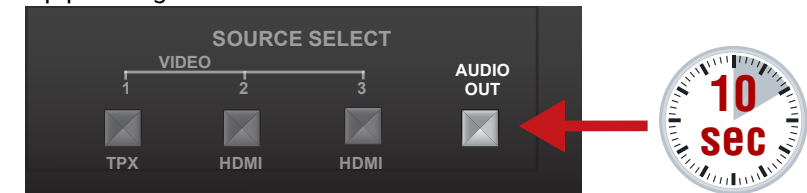

- Step 2.** After 5 seconds the front panel LEDs start blinking, but keep on pressing the button.
- Step 3.** After 10 seconds the LEDs start blinking faster; release the button and press it 3 times again quickly (within 3 seconds).

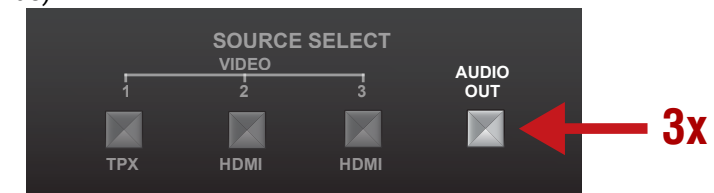

- Step 4.** The LEDs get dark, the device restores the factory default settings and reboots. Factory default settings are listed in the [Factory Default Settings](#) section.

### 3.1.6. Control Lock

Press the **TPX (IN 1)** and **AUDIO OUT** buttons **together** (within 100 ms) to disable/enable front panel buttons; front panel LEDs blink 4 times when locking/unlocking. If the control lock is enabled and a button is pressed, front panel LEDs blink 3 times quickly.

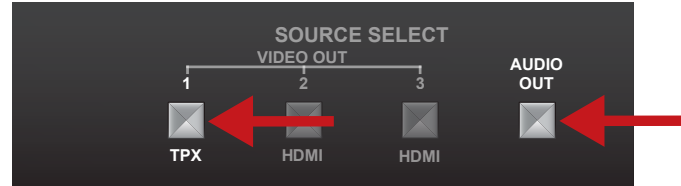

## 3.2. Status LEDs

INFO: When Dark mode is enabled, no LEDs are lit, even though the device is fully functional. For more details about the dark mode, see the [TX Status](#) section.

INFO: The -LCC models have the same values as non-LCC models.

### 3.2.1. Front Panel LEDs

**Live LED (UCX-4x3-TPX-TX20, UCX-2x1-TPX-TX20, UCX-3x3-TPX-RX20)**

LIVE LED		
	blinking	The device is powered on and operational.
	off	The device is not powered or out of operation.

**Arrangement of the status LEDs (UCX-4x3-TPX-TX20, UCX-2x1-TPX-TX20, UCX-3x3-TPX-RX20) #status**

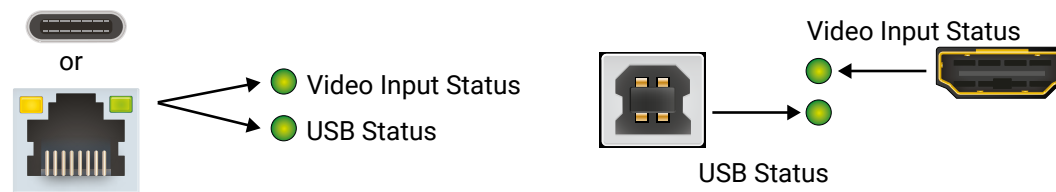

Video Input Status LED (the upper one)		
	off	There is no valid video signal on this port.
	on	There is a valid video signal on this port.
	blinks once	The port is selected by a button press.

USB Status LED (the lower one)		
	off	No USB Host or deselected port.
	on	USB Host connected and selected.
	blink once	Port selected by a button press.

**Video Signal LED (HDMI-UCX-TPX-RX107)**

Video Signal		
	off	No video signal detected on the HDMI output (RX) port.
	on	Video signal is detected on the HDMI output (RX) port.



**Power/LIVE LED (HDMI-UCX-TPX-RX107)**

Video Signal		
	off	The device is not powered.
	blinking between 50% and 100% brightness	The device is powered on and operational.

### 3.2.2. Rear Panel LEDs

Video Output Status		
	off	The signal is not present or muted.
	on	The video signal is present.

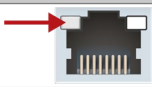
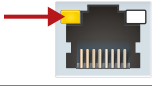
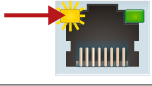
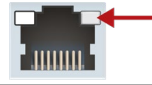
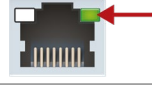
### 3.2.3. Ethernet Status LEDs

LED state	Left LED	Function
	Off	Not linked
	On (Solid)	No activity
	Blinking	Activity
LED state	Right LED	Function
	Off	0 Mbit/s
	On (Solid)	1 Gbit/s
	Blinking	Activity

### 3.2.4. TPX Connector LEDs

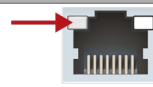
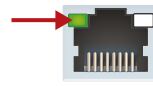
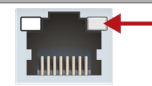
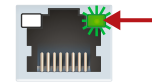
LED state	Left LED	Function
	Off	No connection is established between the transmitter and the receiver units.
	On (Solid)	Connection is established with 10G bandwidth.
LED state	Right LED	Function
	Off	No data transmission on the port.
	On (Blinking)	Data transmission is active

# 4

## Installation

This chapter is about the installation of the devices and connecting to other appliances, also presenting the mounting options and further assembly steps:

- ▶ [MOUNTING OPTIONS](#)
- ▶ [ELECTRICAL CONNECTIONS](#)
- ▶ [POWERING OPTIONS](#)
- ▶ [POWER DELIVERY OVER TYPE-C](#)
- ▶ [USB-C CABLE RECOMMENDATION](#)
- ▶ [CONNECTING STEPS](#)

## 4.1. Mounting Options

To mount the devices, Lightware supplies optional accessories for different usage. There are two kinds of mounting kits with a similar fixing method. The device has two mounting holes with inner thread on the bottom side; see the bottom view in the [Mechanical Drawings](#) section. To order mounting accessories, please contact [sales@lightware.com](mailto:sales@lightware.com). Fasten the device with the screws enclosed to the accessory.

**WARNING!** Always use the supplied screws. Using different (e.g. longer) ones may cause damage to the device.

### Ventilation

**WARNING!** Never block the ventilation holes on any side of the devices! Ensure proper ventilation by letting the air flow freely.

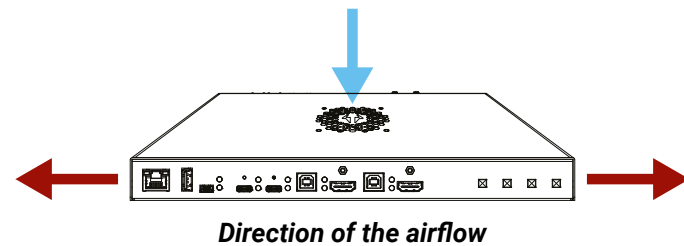

### 4.1.1. 1U High Rack Shelf

Allows rack mounting for half-rack, quarter-rack and pocket sized units.



1U high rack shelf provides mounting holes for fastening two half-rack or four quarter-rack sized units. Pocket-sized devices can also be fastened to the shelf.

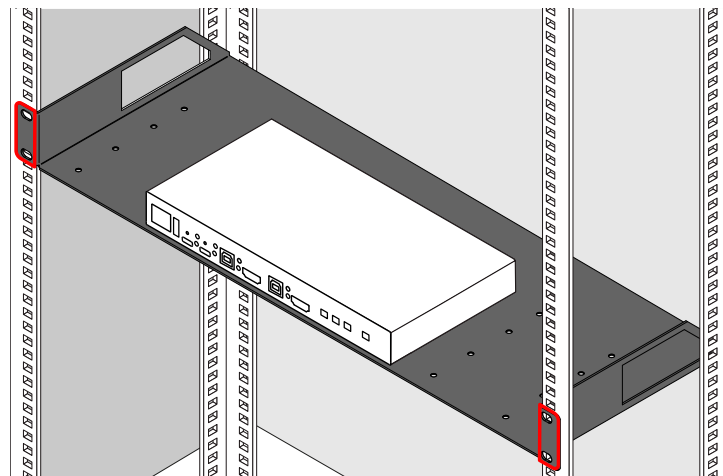

### 4.1.2. Mounting Plate F100

**DIFFERENCE:** The following accessory can be purchased optionally, please contact [sales@lightware.com](mailto:sales@lightware.com).

**INFO:** Please note that this UD Mounting kit is only available for the UCX-4x3-TPX-TX20 and UCX-2x1-TPX-TX20 devices.

The examples demonstrate the applications of the UD Kit accessories:

**Step 1.** Turn the transmitter and the power adaptor upside down.

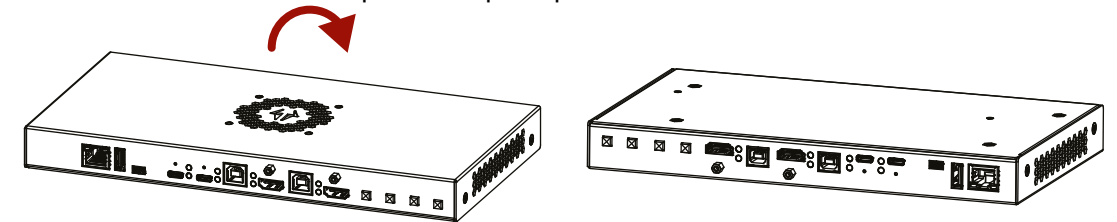

**Step 2.** Fix the UD Mounting plate F100 to the transmitter by fastening the screws (2 pcs screws are supplied with the switcher).

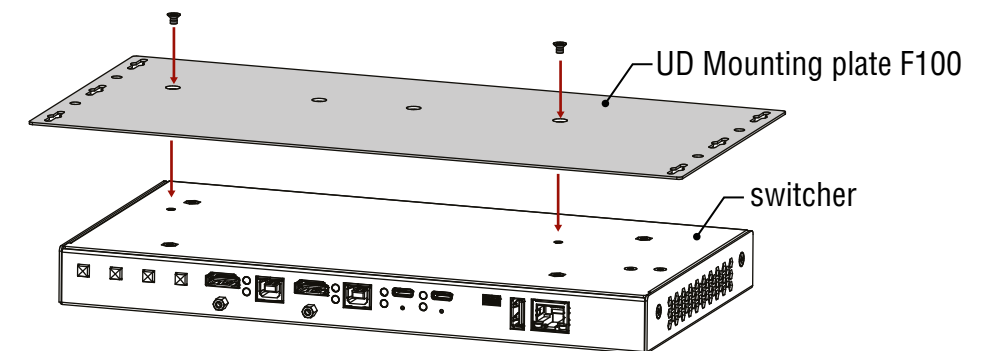

**Step 3.** Fix the UD Mounting plate F100 under the desk by fastening the screws.

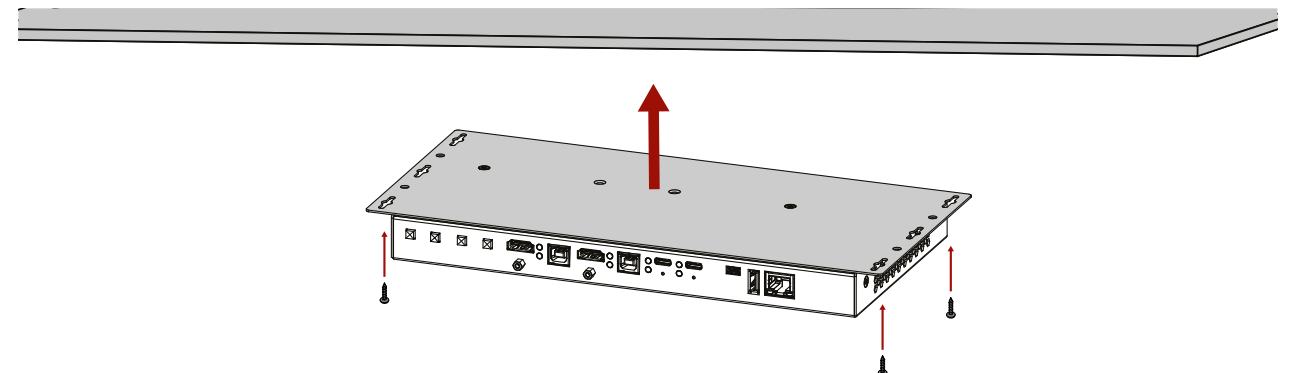

**INFO:** UD Mounting plate F100 does not contain the fixing screws; they can be purchased from the local hardware store. 4pcs M3-M5 metric or wood screws are needed, M3 size is recommended.

**ATTENTION!** To ensure the correct ventilation and avoid overheating, insert the transmitter face down to

the **UD Mounting plate F100** to keep the ventilation holes free.

#### 4.1.3. UD Mounting Plate F110

The UD Mounting Plate F110 makes it easy to mount a quarter-rack device on any flat surface (e.g. a piece of furniture).

**INFO:** Please note that this UD Mounting kit is only available for the HDMI-UCX-TPX-RX107 device.

**ATTENTION!** To ensure the correct ventilation and avoid overheating, insert the receiver face down to the **UD Mounting plates** to keep the ventilation holes free.



#### 4.1.4. UD Mounting Pro P210

The **UD Mounting Pro P210** plate makes it easy to mount a single device on any flat surface (e.g. a piece of furniture).

**INFO:** Please note that this UD Mounting kit is only available for the UCX-4x3-TPX-TX20 and UCX-2x1-TPX-TX20 devices.

**INFO:** **UD Mounting Pro P210** does not contain the fixing screws; they can be purchased from the local hardware store. 2x4pcs M3-M5 metric or wood screws are needed, M3 size is recommended.

**ATTENTION!** To ensure the correct ventilation and avoid overheating, insert the transmitter face down to the **UD Mounting Pro P210** to keep the ventilation holes free.

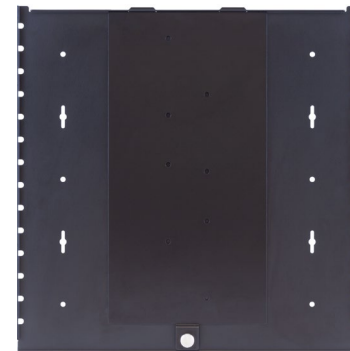

#### 4.1.5. UD Mounting Pro P110

**INFO:** Please note that this UD Mounting kit is only available for the HDMI-UCX-TPX-RX107 device.

The **UD Mounting Pro P110** plate makes it easy to mount a single device on any flat surface (e.g. a piece of furniture).

**UD Mounting Pro P110** does not contain the fixing screws; they can be purchased from the local hardware store. 2x4pcs M3-M5 metric or wood screws are needed, M3 size is recommended.

**ATTENTION!** To ensure the correct ventilation and avoid overheating, insert the transmitter face down to the **UD Mounting Pro P110** to keep the ventilation holes free.



#### 4.1.6. C-Lock

The USB-C Cable Lock is a product designed to enhance the security and reliability of a physical connection by providing a 2-point securing option for connected USB-C cables. *#new*

**Step 1.** Plug the USB-C cable in.

**Step 2.** Fix the C-Lock with the M2 screw.

**Step 3.** Use the provided zip ties to fasten the flange to the USB-C connector.





## 4.2. Electrical Connections

### 4.2.1. HDMI Input and Output Ports

The UCX series matrix switcher extenders are assembled with standard 19-pole HDMI connectors with screw lock for inputs and outputs. Always use high quality HDMI cables for connecting sources and displays.

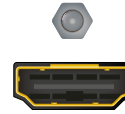

**DIFFERENCE:** UCX-2x1-TPX-TX20 model has no HDMI output.

### 4.2.2. USB Connectors

#### USB Type-C

**ATTENTION!** The USB-C port(s) of the transmitter are developed to connect native USB-C sources. HDMI-USB-C or DP-USB-C adapters are not supported and not recommended to apply.



The transmitter is supplied with USB 2.0 USB C-type port for video, USB data, and Ethernet transmission. It provides power delivery for a max. of two connected devices up to 60W or 100W for the first connected device. Supported power profiles: 5V/3A, 9V/3A, 15V/2A, 15V/3A, 20V/1.5A, 20V/3A, 20/5A. USB-C connector has symmetrical plug and pin layout.

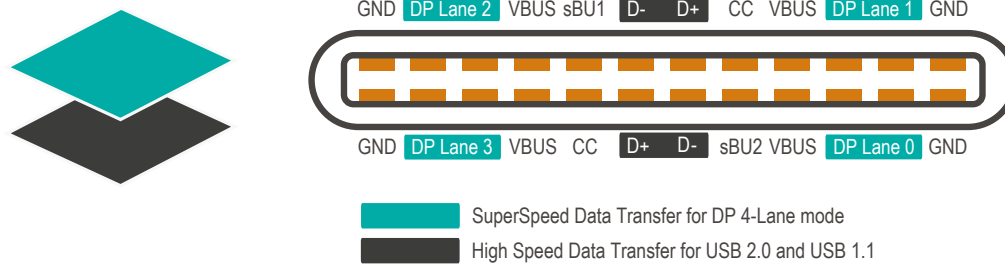

**ATTENTION!** USB-C functionality and speed depend on the cable and the device. Mandatory features of the USB-C - USB-C cables are: USB 2.0 (480 Mbps), min. 3A current, min. 60W power.

**ATTENTION!** In order to charge the connected device with 100W, it is necessary to use a certified cable supporting 20V/5A.

#### USB Type-A

UCX-TPX series have USB 2.0 (max. 480 Mbps data speed) USB A-type ports for connecting USB peripherals.



The 5V output power capability can be turned on and off for all ports. All ports are able to supply 1.66A.

#### USB Type-B

The switcher is supplied with USB 2.0 (max. 480 Mbps data speed) B-type ports for connecting USB hosts.



**INFO:** The black color inside the connector refers to the USB 2.0 data speed.

### 4.2.3. Analog Stereo Audio

A 5-pole Phoenix® connector is used for balanced analog audio output. Unbalanced audio devices can be connected as well. See more details about the balanced and unbalanced output port wiring in the [Cable Wiring Guide](#) section.



Pin nr.	Signal
1	Left+
2	Left-
3	Ground
4	Right-
5	Right+

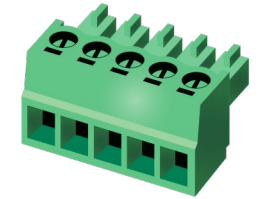

*Analog audio connector and plug pin assignments*

#### Compatible Plug Type

Phoenix® Combicon series (3.5mm pitch, 5-pole), type: MC 1.5/5-ST-3.5.

### 4.2.4. TPX Connector

The UCX-TPX series extenders provide standard RJ45 connectors for TPX input/output ports. Always use high quality Ethernet cables for connecting the transmitters and the receivers.

#### Wiring of CATx Cables

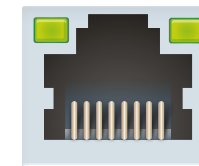

Pin	TIA/EIA T568A	TIA/EIA T568B
1	white/green	white/orange
2	green	orange
3	white/orange	white/green
4	blue	blue
5	white/blue	white/blue
6	orange	green
7	white/brown	white/brown
8	brown	brown

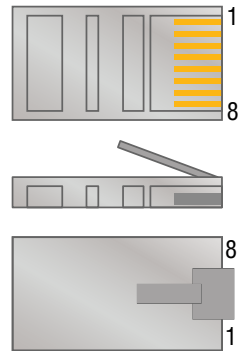

### 4.2.5. Configurable Ethernet Port









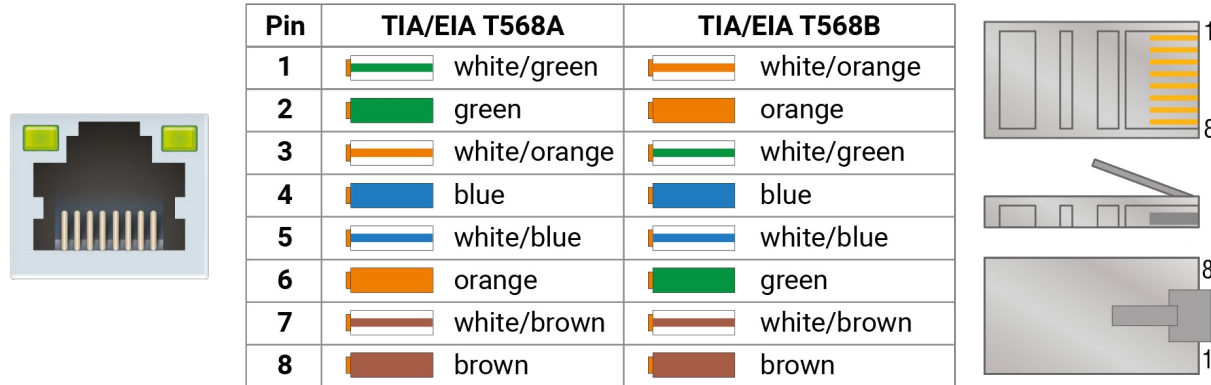







The extenders contain RJ45 connectors for 1Gbit Ethernet/LAN connection for local control functions.

The Ethernet ports can be connected to a LAN hub, switch or router by a CATx cable. Even though both cable types (straight or cross) are supported and handled by the device, the pin assignment below is recommended.

#### Wiring of LAN Cables

Lightware recommends the termination of LAN cables on the basis of TIA/EIA T 568 A or TIA/EIA T 568 B standards.



Pin	TIA/EIA T568A	TIA/EIA T568B
1	 white/green	 white/orange
2	 green	 orange
3	 white/orange	 white/green
4	 blue	 blue
5	 white/blue	 white/blue
6	 orange	 green
7	 white/brown	 white/brown
8	 brown	 brown

**INFO:** The Transmitter is capable of sending power to the Receiver over Ethernet through the TPX output port.

### 4.2.6. OCS Connector

**DIFFERENCE:** UCX-4x3-TPX-TX20 and UCX-2x1-TPX-TX20 models do not have an OCS connector.

The switcher receiver is supplied with a 3.81mm 3-pole 90° Reversed Gender Plug Phoenix® connector, which is used for connecting an occupancy sensor. The first pin is a 24V logic input. The default state is high. Different type of sensors exist: some send high level, some send low level to this input when the room is occupied. Active-high or active-low logic can be configured for this port in LDC to support them. The second pin has a constant 24V output voltage, and the third one is the ground.



Pin nr.	Signal
1	24V logic input
2	24V
3	Ground

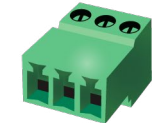

#### OCS connector pin assignments

Voltage ranges for 1st pin are the following:

	Input voltage [V]
<b>Logic low level</b>	0 - 0.8
<b>Logic high level</b>	2V- 24V

OCS Output Voltage Level: 24V (50mA).

Pull-up resistor is integrated on the input. Works automatically with open-drain type sensors. Requires an external 1kR pull-down resistor between input and ground pins when used with active-high type sensors.

#### Compatible Plug Type

WR-TBL series (3.81mm 3-pole 90° Reversed Gender Plug Phoenix), type: WR-TBL Series 3483 - 3.81 mm.

**ATTENTION!** The occupancy sensor connector and the GPIO port are not compatible with each other due to voltage level difference, please do not connect them directly.

#### 4.2.7. GPIO - General Purpose Input/Output Ports

The switcher transmitter is supplied with an 8-pole Phoenix® connector with six GPIO pins that operate at TTL digital signal levels, and can be set to high or low level (Push-Pull). The direction of the pins can be input or output (adjustable). Voltage ranges for GPIO inputs are the following:

	Input voltage [V]	Output voltage [V]	Max. output current [mA]
Logical low level	0 - 0.8	0 - 0.5V	30
Logical high level	2 - 5	4.5 - 5V	18

The maximum total current for the six GPIO pins is 180 mA.



Pin nr.	Signal
1	Configurable
2	
3	
4	
5	
6	
7	5V
8	Ground

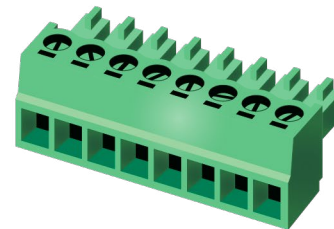

**GPIO connector and plug pin assignments**

**INFO:** The recommended cable for the connectors is the AWG24 (0.2 mm<sup>2</sup> diameter) or the generally used 'alarm cable' with 4x0.22 mm<sup>2</sup> wires.

#### Compatible plug type

Phoenix® Combicon series (3.5mm pitch 8-pole), type: MC 1.5/8-ST-3.5.

**ATTENTION!** The occupancy sensor connector and the GPIO port are not compatible with each other because of the voltage level difference, please do not connect them directly.

#### 4.2.8. RS-232 Connector

The extenders contain a 3-pole Phoenix® connector, which is used for RS-232 serial connection.



Pin nr.	Signal
1	Ground
2	TX data
3	RX data

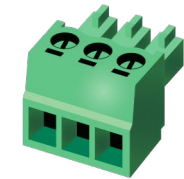

**RS-232 connector pin assignments**

#### RS-232 Output Voltage Levels

- Logic low level: 3V .. 15V
- Logic high level: -15V .. -3V

#### Compatible Plug Type

Phoenix® Combicon series (3.5mm pitch, 3-pole), type: MC 1.5/3-ST-3.5.

You can find more information about RS-232 in the [Serial Interface](#) section.

### 4.3. Powering Options

INFO: The external power supply is not isolated, 230V side is galvanically connected to the 0 output pole.

INFO: The -LCC models have the same values as non-LCC models.

#### Powering Locally

The UCX-TPX Transmitter devices and the UCX-3x3-TPX-TX20 model are built with 2-pole Phoenix connector for DC power connection.



**WARNING!** The external power adaptor for UCX-3x3-TPX-RX20 is not suitable for the UCX-TPX transmitter devices or vice versa. Please make sure to use the correct power adaptors for your devices!

The HDMI-UCX-TPX-RX107 receiver is built with a lockable 12V DC connector.

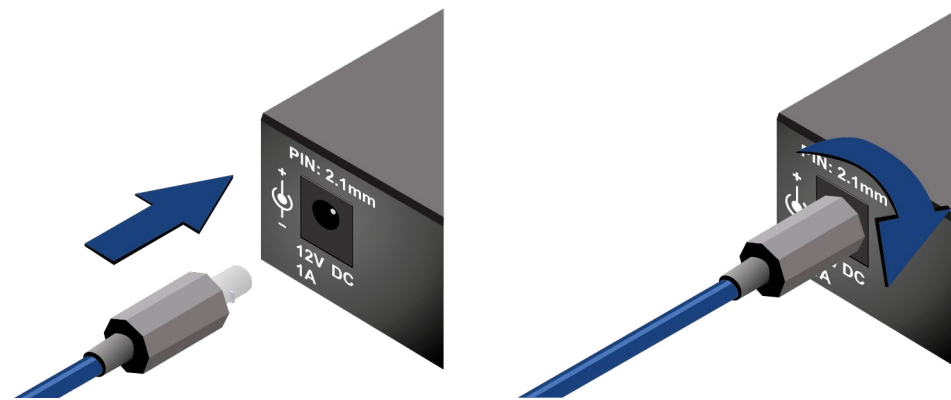

Do not forget to turn the plug counterclockwise before disconnecting the power adaptor.

Details of the powering information are as follows:

Device Name	Voltage		Electric Current	
	12V	24V	2A	6.6A
UCX-4x3-TPX-TX20		✓		✓
UCX-2x1-TPX-TX20		✓		✓
UCX-3x3-TPX-RX20	✓			✓
HDMI-UCX-TPX-RX107	✓		✓	

#### Remote Powering the HDMI-UCX-TPX-RX107

HDMI-UCX-TPX-RX107 can be powered over the TPX input port by a UCX-TPX Transmitter device.

#### Remote Powering via USB-C Ports

The UCX-4x3-TPX-TX20 and UCX-2x1-TPX-TX20 models are designed to provide power delivery for the connected device over the USB-C connector(s).

The following operation modes are available:

- Charge one device on the first connected port with up to 100W. Supported power profiles: 5V/3A, 9V/3A, 15V/3A, 20V/3A, 20V/5A

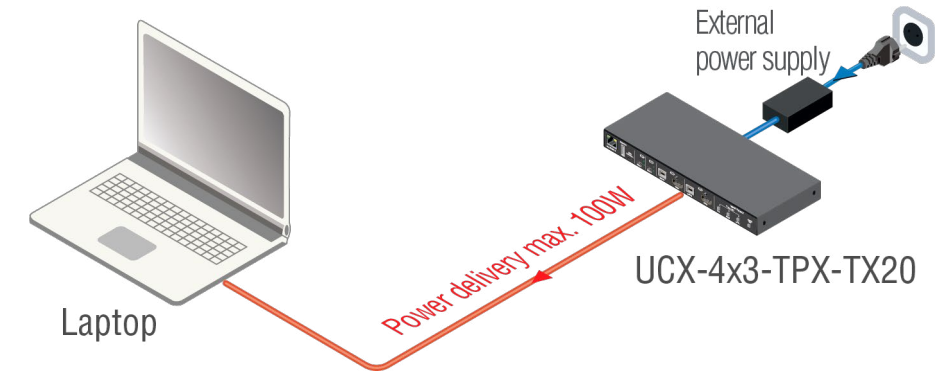

- Charge both devices with 60W. Supported power profiles: 5V/3A, 9V/3A, 15V/2A, 20V/1,5A

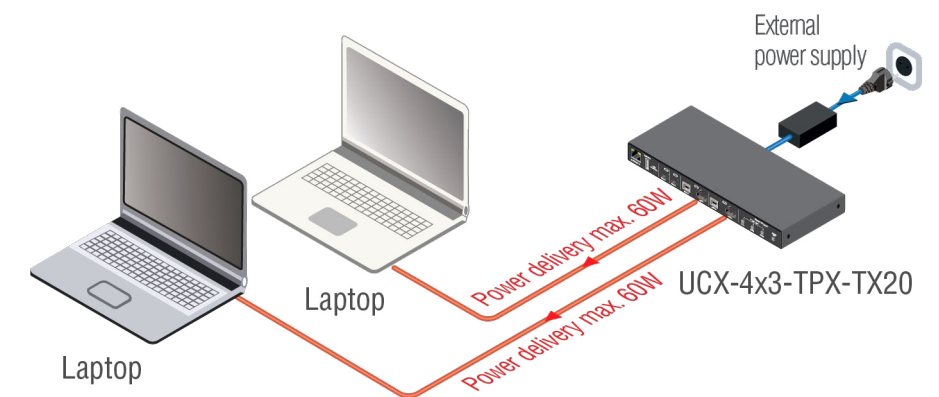

**WARNING!** Always use the supplied power supply! Use of any other power supplies may lead to damage! Warranty void if damage occurs due to using a different power source.

INFO: Selecting the appropriate power profile happens automatically, no manual intervention required.

INFO: Charging two devices at once is only available with UCX-4x3-TPX-TX20.

#### Remote Powering via USB-A Ports (D1-D4)

5V output power capability can be turned on and off for all ports. All ports are able to supply 1.66A.

#### Remote Powering via RJ45 ports

The UCX-4x3-TPX-TX20 and UCX-2x1-TPX-TX20 models are capable of remote powering the HDMI-UCX-TPX-RX107 via connection between the TPX ports with a CATx cable.

### 4.4. Power Delivery over Type-C

With Power delivery, these issues were solved:

- Allows negotiation of **up to 100 W** of power delivery to supply or charge equipment connected to a USB-C port.
- Power direction is **not fixed**.
- Intelligent and flexible system-level **management of power** (negotiation); the two connected partners exchange real-time PD protocol messages through the CC (control channel) lines.

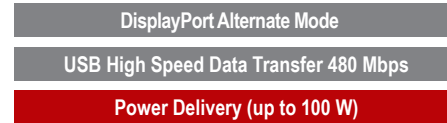

USB PD supersedes all previous technologies and does not incorporate them. It can achieve any of the previous levels, but does so with its own methods.

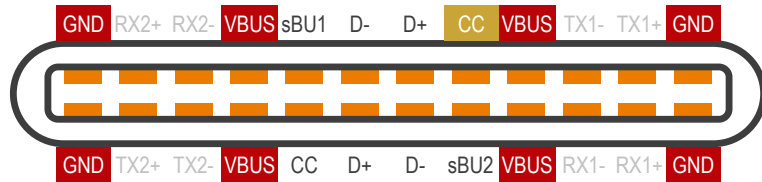

**Power Pins of USB-C Connector**

- The VBUS and GND pins are power and the return paths for the signals
- The CC channel is used for power negotiation
- The other CC pin can be used for VCONN powering

#### USB Chargers

USB-C PD covers a range of different power levels, with different amperage and voltage combinations that a charger can deliver, depending on what the device asks for and the cable negotiates. These values are defined by PDO (Power Data Objects).

According to the specification, 12V is not a mandatory Voltage level. The reason for support in case of certain chargers is that the 12V value was on the mandatory list of a former specification.

#### 4.4.1. Power Data Objects (USB-C)

Power Data Object (PDO) defines a power capability:

- Nominal voltage and maximum current
- A Source must have at least one PDO
- The Sink chooses one of the Source's PDOs via CC communication

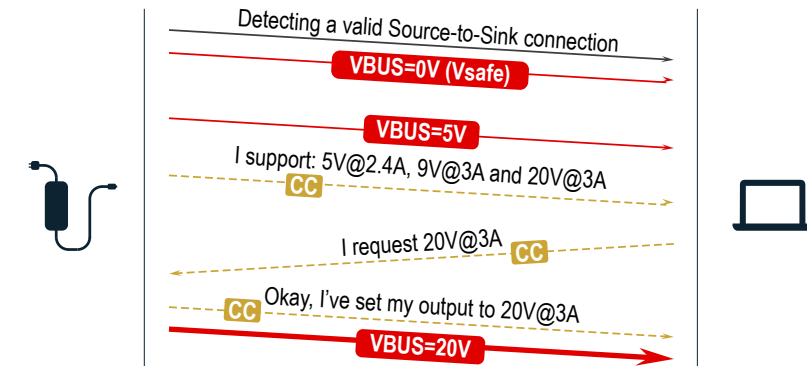
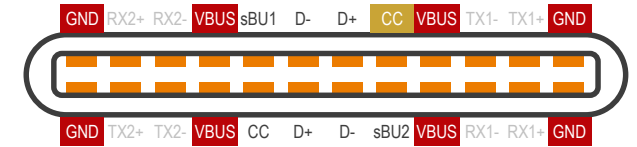

**Powering Handshake**

#### Dual-Role Power

With USB-C, the connector is the same on all products. Laptops, certain tablets and smartphones can be both a charger and a charged device (not simultaneously). Source/Sink defines the power role the port is currently operating in.

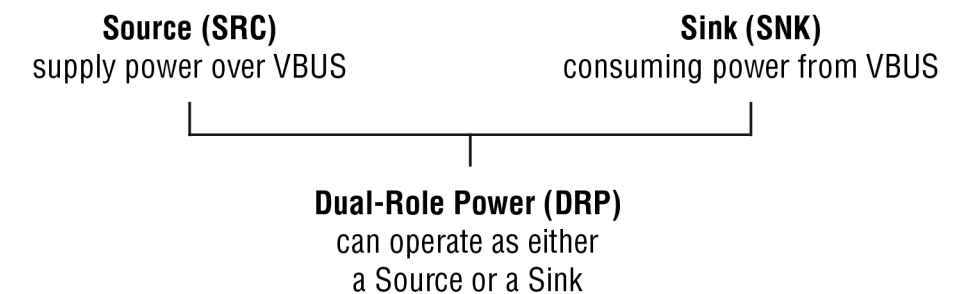

	Source-only	Sink-only	Dual-Role Power
Source-only	Non-functional	Functional	DRP = Sink
Sink-only	Functional	Non-functional	DRP = Source
Dual-Role Power	DRP = Sink	DRP = Source	DRPs negotiate

## 4.5. USB-C Cable Recommendation

Please find the recommendations for the applied cables below:

- Use Full-featured USB Type-C cables made by reliable brands.
- USB2.0 cables do not have the Superspeed channels, neither DP video, nor USB3 transmission works with them.
- Type-C cables certified for USB 3.x Gen1-Gen2 (5Gbps or 10Gbps) and Displayport Alternate mode HBR2-HBR3 (5.4Gbps or 8.1Gbps) applications are recommended.
- Thunderbolt cables are not backwards compatible with USB3.x or Displayport unless the manufacturer explicitly states so.
- Passive, 20Gbps Thunderbolt 3 cables, which are also specified for USB3.x are a good, but more expensive choice.
- 5A charging capability is advised (for charging with 100W). However, all USB Type-C cables should support at least 3A (up to 60W) charging.

### 4.6. Connecting Steps

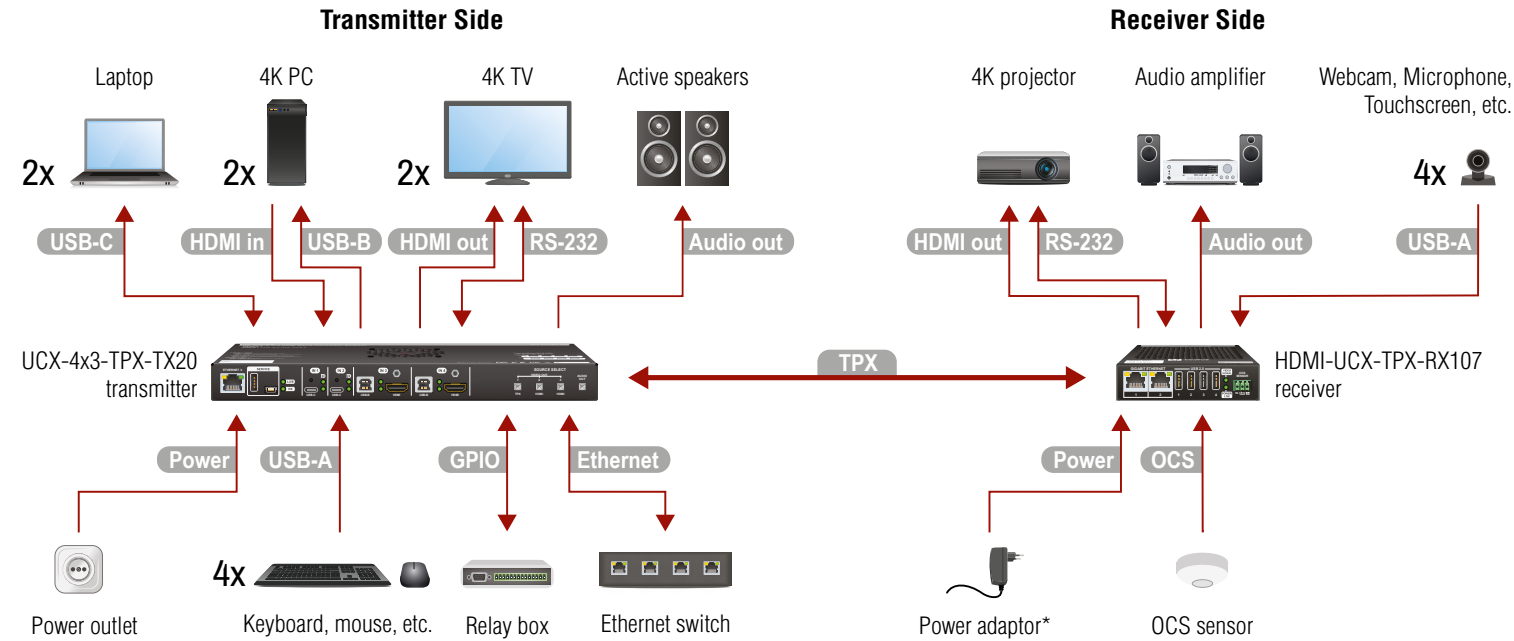

Transmitter side	
<b>TPX</b>	Connect a CATx cable between the TPX output port of the transmitter and the TPX input port of the receiver.
<b>USB-C</b>	Connect a USB-C source (e.g. BYOD laptop) to the USB-C input port. The applied cable shall be certified for Displayport Alternate mode HBR2 (4x5.4Gbps) applications.
<b>HDMI in</b>	Connect an HDMI source (e.g. BYOD laptop or room PC) to the HDMI input port.
<b>Ethernet</b>	Optionally connect the device to a LAN network.
<b>USB</b>	<b>USB Type-A:</b> Optionally connect the USB device (e.g. keyboard and mouse). <b>USB Type-B:</b> Optionally connect the USB host (e.g. PC).
<b>HDMI out</b>	Connect an HDMI sink (e.g. projector) to the HDMI output port.
<b>RS-232</b>	Optionally for RS-232 extension: connect a controller/controlled device (e.g. projector) to the RS-232 port.
<b>Audio out</b>	Optionally connect an audio device (e.g. active speakers) to the analog audio output port by an audio cable.
<b>GPIO</b>	Optionally connect a device (e.g. a relay box) to the GPIO port.
<b>Power</b>	Connect the external power supply to the AC power socket and the switcher unit. Powering the device is recommended as the final step.

**ATTENTION!** Please only connect one side (TX or RX) to the LAN, otherwise a loop may be created.

Receiver side	
<b>TPX</b>	Connect a CATx cable between the TPX output port of the transmitter and the TPX input port of the receiver.
<b>HDMI out</b>	Connect a sink (e.g. projector) to the HDMI output port.
<b>USB</b>	<b>USB Type-A:</b> Optionally connect the USB device (e.g. webcams or USB sticks).
<b>RS-232</b>	Optionally for RS-232 extension: connect a controller/controlled device (e.g. projector) to the RS-232 port.
<b>Audio out</b>	Optionally connect an audio device (e.g. audio amplifier) to the analog audio output port by an audio cable.
<b>OCS</b>	Optionally connect an occupancy sensor to the OCS port.
<b>Power</b>	Connect the external power supply to the AC power socket and the switcher unit. Powering the device is recommended as the final step. *Connecting the power adaptor is only necessary if the receiver is not being powered over Ethernet by the transmitter.

**ATTENTION!** The USB-C ports of Taurus are developed to connect native USB-C sources. HDMI-USB-C or DP-USB-C adapters are not supported and not recommended to apply.

**INFO:** Connecting USB-B and HDMI ports to the same PC or laptop is recommended in case of IN3 and IN4 inputs (IN2 in case of UCX-2x1-TPX-TX20).

# 5

## Device Concept

The following chapter describes the features of the devices with a few real-life examples:

- ▶ UNIVERSAL SWITCHER CONCEPT
- ▶ USB INTERFACE
- ▶ VIDEO INTERFACE
- ▶ THE AUTOSELECT FEATURE
- ▶ AUDIO INTERFACE
- ▶ ETHERNET INTERFACE
- ▶ LIGHTWARE ADVANCED ROOM AUTOMATION (LARA)
- ▶ BASIC NETWORK SECURITY
- ▶ 802.1x AUTHENTICATION
- ▶ ADVANCED ETHERNET SECURITY
- ▶ LIGHTWARE CRYPTO CORE
- ▶ WEBSOCKET SERVICE (WS, WSS)
- ▶ BULK DEVICE MANAGEMENT
- ▶ SERIAL INTERFACE
- ▶ GPIO INTERFACE
- ▶ OCS INTERFACE
- ▶ FURTHER BUILT-IN FEATURES



## 5.1. Universal Switcher Concept

Lightware's universal switcher transmitter exploits the USB-C connectivity for a simplified transmission of 4K video, audio, control signals and power providing meeting participants with easy host switching, utilizing data speeds of up to 480 Mbps under the USB 2.0 providing video supporting up to 4k@60Hz at 4:4:4 video resolution.

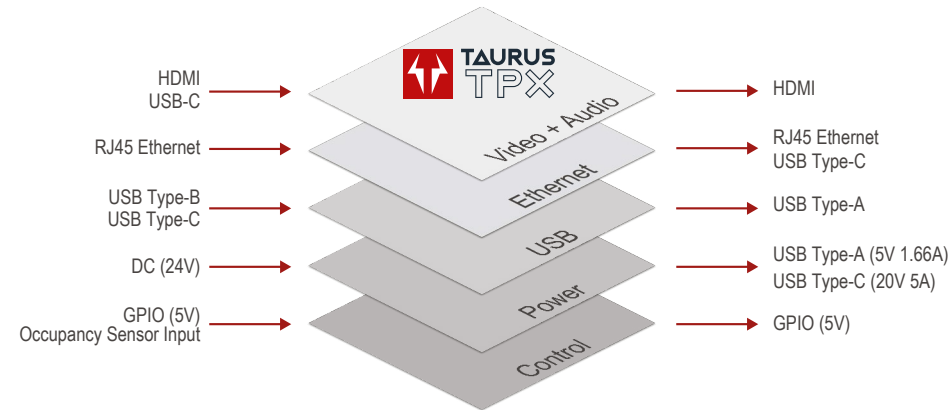

## 5.2. USB Interface

### 5.2.1. USB-C Interface

USB-C Pinout and Data Channels

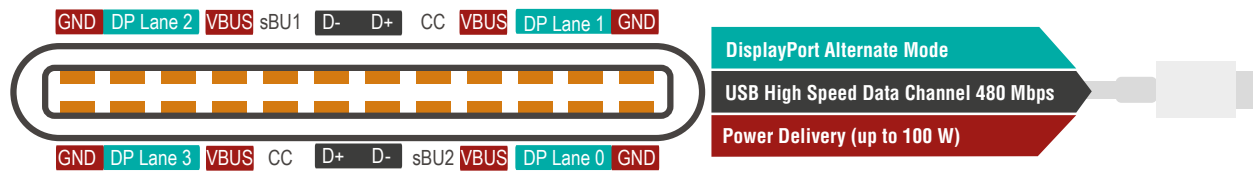

The USB-C interface consists of three main layers:



#### USB Data

- USB 2.0 data (480 Mbps) is transferred over the High-speed data channels. The built-in USB-Ethernet bridge provides Ethernet connection over the USB-C connector. This function uses the High-speed channels. For more details, see the [USB Port Diagram \(UCX-4x3-TPX-TX20\)](#) and the [Ethernet Interface](#) section.

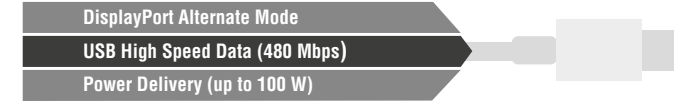

#### Displayport Alternate Mode (Video + Embedded Audio)

- DisplayPort Alternate Mode:** Alternate mode is designed for carrying uncompressed, native Displayport video as non-USB data (All Superspeed Data lanes deliver video signals, it reserves the whole bandwidth of the SS Lines).

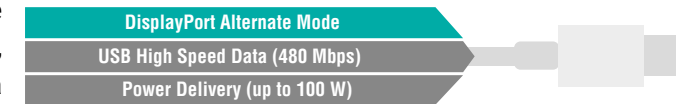

#### Power Delivery

- Going outward to power/charge external devices.

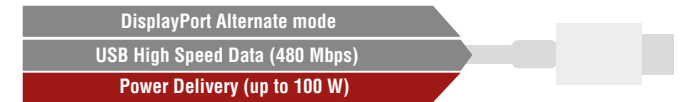

### 5.2.2. USB Data - USB Interface

Summary of USB ports

	Upstream ports (UFP)			Downstream ports (DFP)	
	USB-C 2.0 (480 Mbps)	USB-B 2.0 (480 Mbps)	USB-B 3.1 (5Gbps)	USB-A 2.0 (480 Mbps)	USB-A 3.1 (5Gbps)
UCX-4x3-TPX-TX20	2x	2x	-	4x	-
UCX-2x1-TPX-TX20	1x	1x	-	4x	-
UCX-3x3-TPX-RX20	-	-	2x	-	4x
HDMI-UCX-TPX-RX107	-	-	-	4x	-

INFO: The -LCC models have the same values as non-LCC models.

**USB Port Diagram (UCX-4x3-TPX-TX20)**

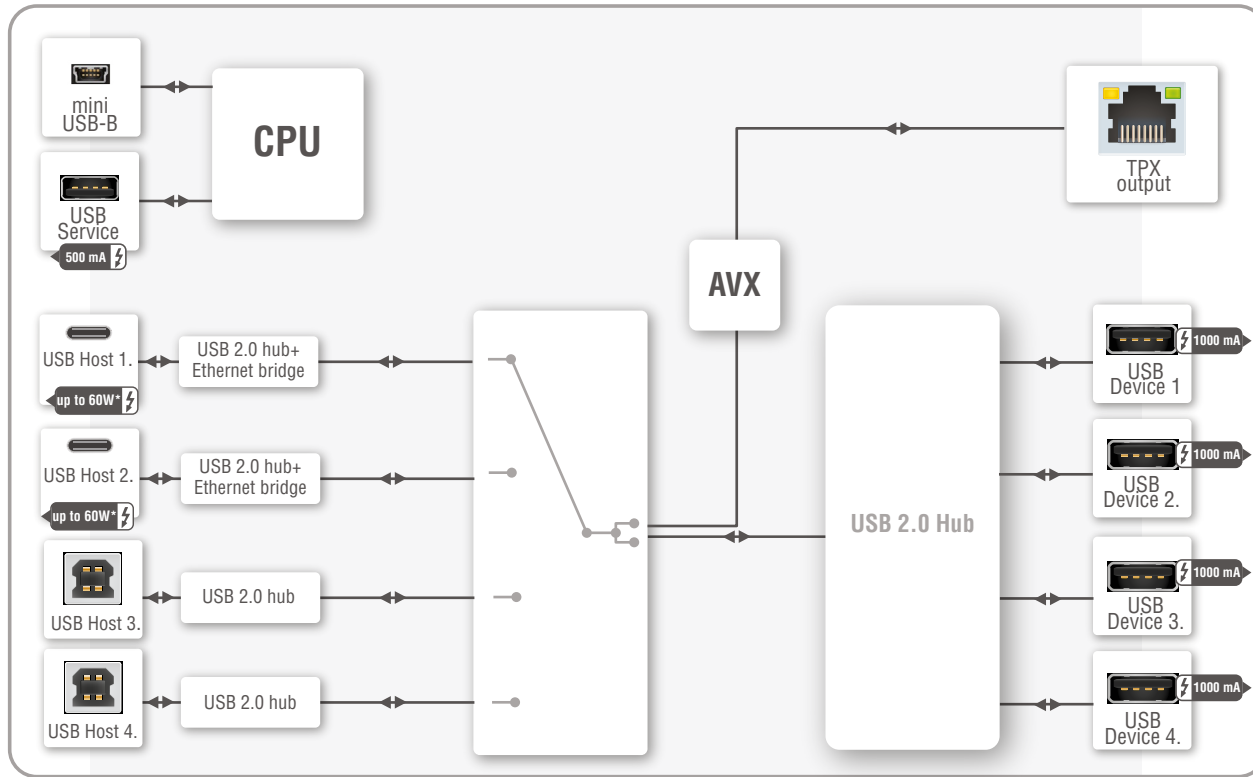

\* For more details about the power delivery of the USB-C port, see the [Powering Options](#) section.

**INFO:** The UCX-TPX series devices present 2 tiers in the USB topology due to the USB2 layer (two HUBs). USB-A, USB-B and USB-C connectors also have high-speed data lines besides Superspeed.

The built-in USB-Ethernet bridge provides Ethernet for the USB-C connection. It is still available while the USB data channels are reserved for video or USB data transmission. For more details, see the [Ethernet Port Diagram \(UCX-4x3-TPX-TX20\)](#).

**USB Features**

**DisplayPort Alternate Mode**

This function is available only for USB type C connectors. See more details in the [DisplayPort Alternate Mode](#) section.

**Host detection**

One host is available at once. UCX-TPX series devices give a feedback about the connected hosts.

In case of USB Type-B ports: When the 5V is detected on USB Vbus, the **Connected** property becomes true.

In case of USB Type-C ports: USB Type-C introduced the port Power Roles: Sink port, Source port and Dual Role Power port. Supplying VBUS is not the privilege of the USB Host anymore.

Detecting the presence of a BYOD device on Type-C ports is done using the Power Delivery protocol over the Communication Channel.

**Sending 5V Power to the Device**

This function allows sending 5V power to the device (USB peripheral). Most USB devices can be powered by this 5V, so disabling and enabling this property is equal to unplugging the USB connector and plugging it back in.

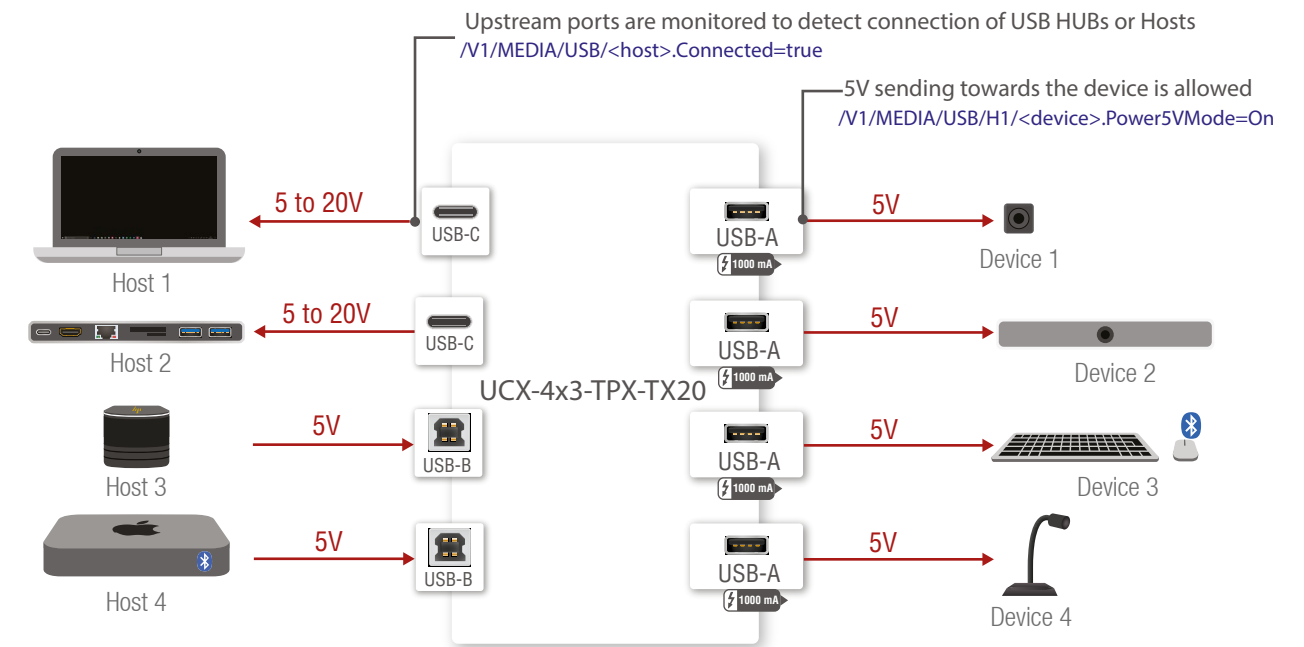

**USB features in the UCX-4x3-TPX-TX20**

**Application of USB - Example**

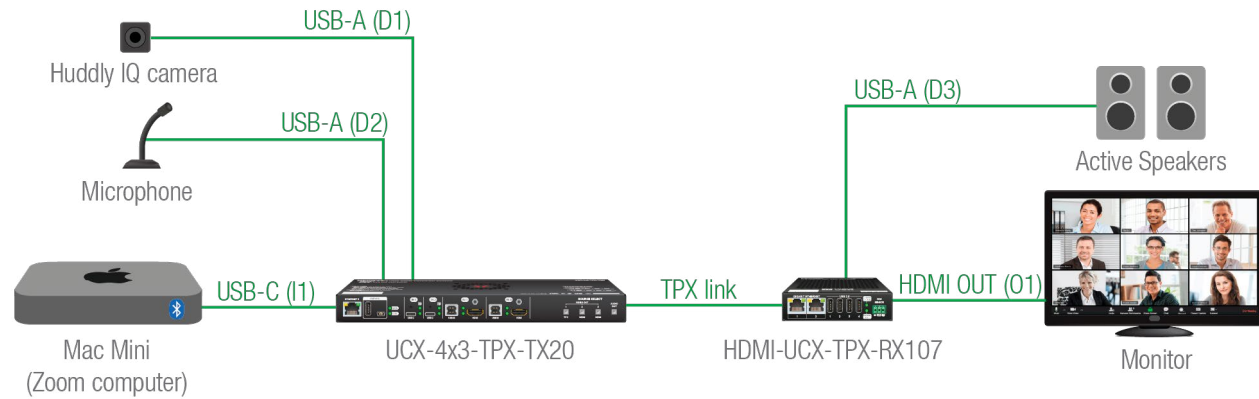

**The Concept**

The Webcam and USB microphone (D2) are connected to the Mac Mini computer(U3) through a USB HUB (UCX-4x3-TPX-TX20). Zoom running on the computer sends video and embedded audio signal to the Taurus HDMI input (I3).



The switcher forwards the signals to the receiver, which routes the analog audio to the active speakers and digital video to the HDMI display.

**Settings**

- Step 1.** In the Crosspoint menu, USB tab, switch the Mac Mini (U3) to the USB hub(H1).
- Step 2.** Pay attention to the connected USB devices (D1 and D2) and turn on the **Power 5V Mode**.
- Step 3.** The video crosspoint is switched to I3-O1.

**5.2.3. USB Service Ports - USB 2.0 Interface**

**Summary of USB 2.0 Service ports**

	Service ports	
	USB-A USB 2.0 (480 Mbps)	mini USB- B USB 2.0 (480 Mbps)
		
UCX-4x3-TPX-TX20	✓	✓
UCX-2x1-TPX-TX20	✓	✓
UCX-3x3-TPX-RX20	✓	✓
HDMI-UCX-TPX-RX107	-	-

The **SERVICE**-labelled USB-A connector is designed for service function. The Mini B-type connector is reserved for future LW3 control. Both features will be added by a future firmware update.

**INFO:** The -LCC models have the same values as non-LCC models.

**5.3. Video Interface**

**ATTENTION!** The USB-C ports of Taurus are developed to connect native USB-C sources. HDMI–USB-C or DP–USB-C adapters are not supported and not recommended to apply.

**Summary of Video Ports**

	#welcomescreen			
	<i>WELCOME</i> Welcome screen option	Displayport Alternate mode HBR2 (4x5.4Gbps)	HDMI 2.0 (18 Gbps)	HDMI 2.0 (18 Gbps)
UCX-4x3-TPX-TX20	✓	2x	2x	2x
UCX-2x1-TPX-TX20	✓	1x	1x	-
UCX-3x3-TPX-RX20	✓	-	2x	3x
HDMI-UCX-TPX-RX107	-	-	-	1x

**INFO:** The -LCC models have the same values as non-LCC models.

**5.3.1. Welcome Screen**

**DEFINITION:** The Welcome screen is an internal source, which can be customized by uploading an image file, jpg, or bmp. Besides this, custom text can be set to display on the output with or without the image.

**DIFFERENCE:** From FW version v1.10.0 the Welcome screen is disabled in the transmitters if the connected Receiver is UCX-3x3-TPX-RX20.

**Rules**

- Welcome screen is an option and appears as an **additional input**.
- The image and the text can be **displayed separately or together** as well.
- If the image option is not enabled, a **light grey screen** is displayed.
- One image can be stored in the device. If a new image is uploaded, the existing one **will be overwritten**.
- The max. image size is 4MB, preferred resolution is 1280x720.
- The text length can be max. **63 characters** and the following characters are allowed: letters (a-z, A-Z), space, hyphen (-), underscore (\_), numbers (0-9) and dot (.). The text color is **black**.
- If no image is uploaded, the factory default image (**Lightware logo**) can be displayed.



**The Default Welcome Screen**

**Limitations**

- If the I1 input port is switched to an output, the **Welcome screen is not available**.
- If the Welcome screen is switched to an output:
  - **I1 input port is not available** and I1 audio cannot be de-embedded to the analog audio output port.
  - I1 does not send hotplug signal and the **signal parameters of the I1 port are not measured**.
- If the audio of the I1 port is switched to the analog audio output and the Welcome screen is switched to the output, **the audio signal is lost**, however, the audio crosspoint is not changed.

**5.3.2. Video Port Diagrams**

**UCX-4x3-TPX-TX20**

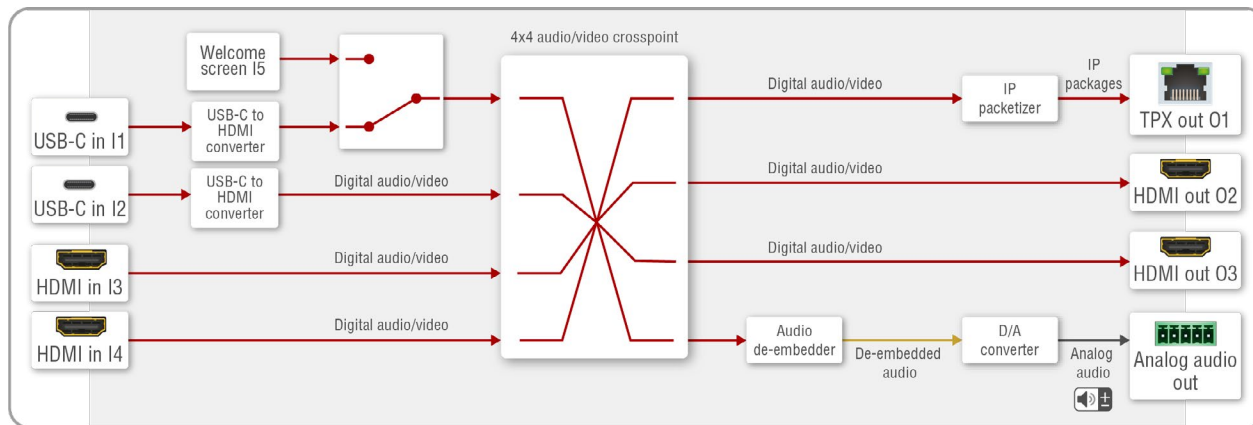

**INFO:** The source that is connected to the USB-C port sends DisplayPort video signal. This signal is converted to HDMI by the video IC internally.

**UCX-2x1-TPX-TX20**

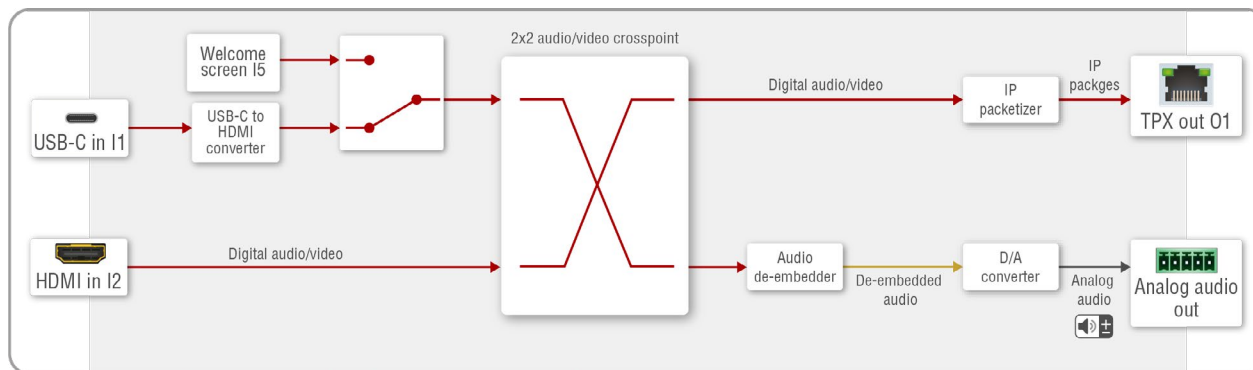

**INFO:** The source that is connected to the USB-C port sends DisplayPort video signal. This signal is converted to HDMI by the video IC internally.

**UCX-3x3-TPX-RX20 #new**

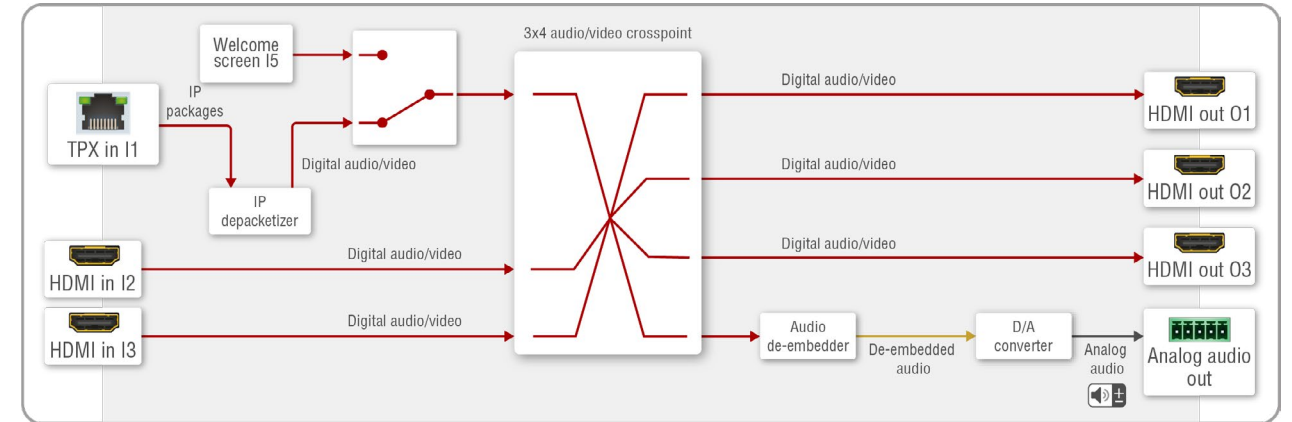

**HDMI-UCX-TPX-RX107**

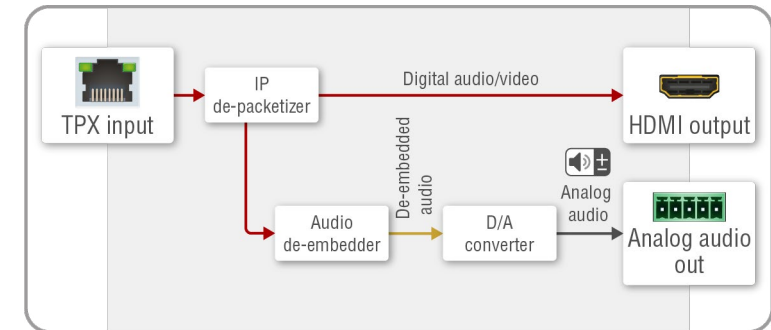

**5.3.3. DisplayPort Alternate Mode**

USB-C sources send Displayport signal for video transmission.

Displayport Alternate mode allows using the USB-C cable instead of DisplayPort cable for DP video signals. The standard uses the Superspeed data transfer channels for carrying the video stream.

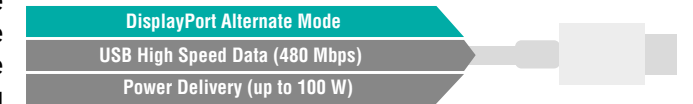

**ATTENTION!** The bandwidth of the video is based on the capacity of the source and the sink. USB3.1 Generation (Gen1=5Gbps, Gen2=10Gbps) is not related to DP bitrate (HBR1=4x2.7Gbps, HBR2=4x5.4Gbps)

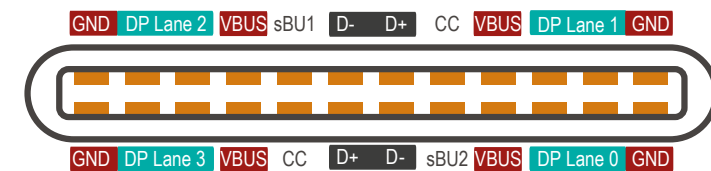

**USB-C pinout in DP Alt mode**

**DIFFERENCE:** From firmware version v1.8.0 and LDC version v2.8.0, UCX-4x3-TPX-TX20 and UCX-2x1-TPX-TX20 models have **2 Lane Video** setting alongside **4 Lane Video** setting in case the latter is not supported. In Alt Mode, 2 or all 4 of the USB-C Superspeed data channels can be configured as DisplayPort lanes. A full-bandwidth DisplayPort connection is always defined as 4 lanes.

The table below shows the correlation of the video resolution and the assigned lanes:

DisplayPort Video			DisplayPort Alternate Mode			
DisplayPort Standard	Raw bandwidth (1 lane)	Display Resolutions	2-Lane DP		4-Lane DP	
			BW	Display Resolutions	BW	Display Resolutions
HBR1 (DP 1.0 / 1.1)	2.7 Gbps	1440p@60 Hz	5.4 Gbps	1 × FullHD	10.8 Gbps	1 × 4K@30 Hz
HBR2 (DP 1.2)	5.4 Gbps	4K@60 Hz	10.8 Gbps	1 × 4K@30 Hz	21.6 Gbps	1 × 4K@60 Hz

### 5.4. The Autoselect Feature

Aside from manually selecting crosspoints, you can choose the Autoselect option in case of video and USB ports.

Video input source can be selected in the following ways:

- using the front panel buttons
- using Lightware Device Controller (LDC)
- sending LW3 protocol command or
- using the Autoselect function.

There are three Autoselect policies as follows:

- Disable autoselect
- First detect
- Last detect
- Follow video (in case of USB and audio ports)

**INFO:** SignalPresent cannot be sensed on I1 if I5 is displayed due to the mutually exclusive operation of video input I1 and the internal Welcome screen image generator I5. Welcome screen image will disappear and the video crosspoint will be switched to I1 upon connecting a Host computer to I1, regardless of whether the computer sends Displayport image or not.

#### Individual input settings

This setting defines the priority level of the ports. The priority property is valid both for first detect and last detect operation modes. It overrides the chronological order of the appearance of the active video signal. The highest priority active input is always selected to transmit (1- highest priority, 100- lowest priority).

**TIPS AND TRICKS:** To use the individual input settings, change the default priority settings from 1 to 5 depending on their importance (e.g. I1 priority:1; I2 priority:2; I3 priority:3; I4 priority:4; I5 priority:5).

**ATTENTION!** The autoselect function remains active after the manual crosspoint switching. This operation mode works in contrast to the other Lightware matrix switchers or extenders.

#### Disable autoselect

The crosspoint state change only happens manually.

#### First detect

The selected input port is kept connected to the output as long as it has an active signal. The crosspoint changes when the signal becomes inactive on the chosen input, or when the video signal appears on a higher priority port.

**TIPS AND TRICKS:** To uphold the first detect mode, default priority settings (I1 priority:50; I2 priority:50; I3 priority:50; I4 priority:50; I5 priority:100) are appropriate. Lower priority of the I5 port is highly recommended, because this is an internal source with constant video signal, thus this port is always the first one.

#### Last detect

It is always the last attached input that is selected to transmit. The crosspoint changes when the signal becomes inactive on the chosen input, or when the active video signal appears on a port with the same or higher priority.

**TIPS AND TRICKS:** To uphold the last detect mode, default priority settings (I1 priority:50; I2 priority:50; I3 priority:50; I4 priority:50; I5 priority:100) are appropriate.

#### Automatic Input Selection - Example 1.

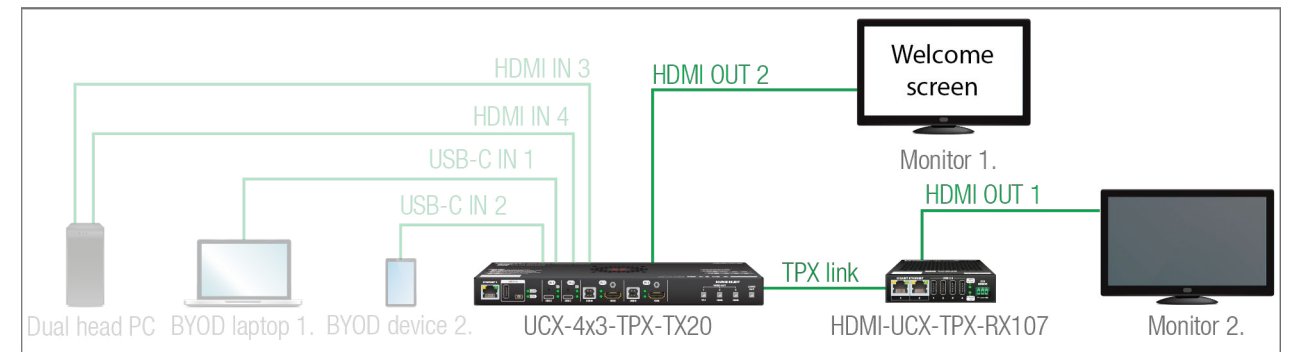

The Welcome screen appears on the Monitor 1. (O2) when no active source is connected.

The video signal of the dual-head PC (I3, I4) can be seen on Monitor 1. and Monitor 2. (O2 and O3) when it is powered on and no BYOD device is connected.

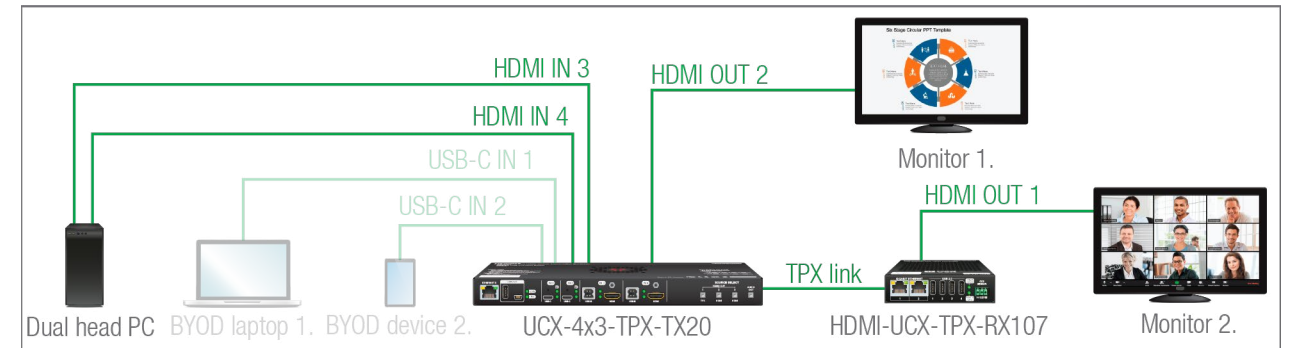

BYOD laptop 1. (I1) is displayed on Monitor 1. (O2) and BYOD device 2. (I2) can be seen on Monitor 2. when they are connected and send active video signal. The individual input settings are the following:

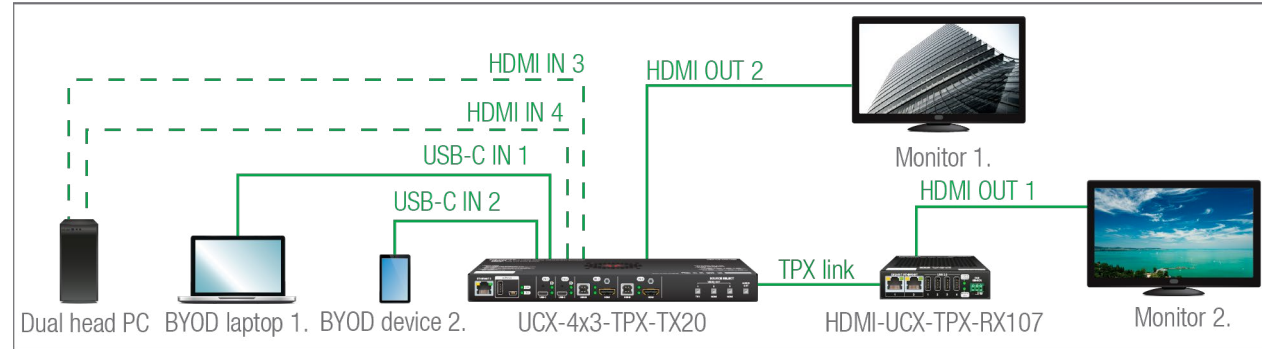

O1: I1 priority:1; I2 priority: disabled; I3 priority:2; I4 priority: disabled; I5 priority:3  
 HDMI OUT: I1 priority: disabled; I2 priority: 1; I3 priority: disabled; I4 priority: 2; I5 priority: disabled

**Automatic Input Selection - Example 2.**

One of the BYOD laptops is switched to Monitor 1. depending on the operation policy (Last detect/first detect) and the connection order of the BYOD laptops. The USB autoselect mode should be **Follow video**, the USB peripherals (webcam, microphone etc.) are connected to the chosen laptop. The USB Type-C provides Ethernet to the BYOD device, so the conferencing software can run there.

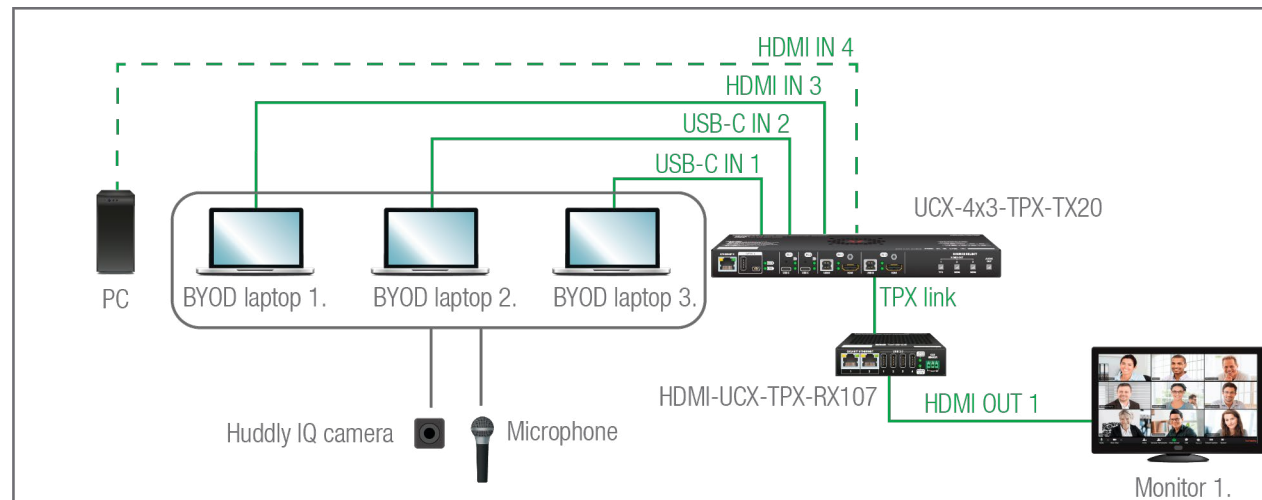

When no active BYOD device is connected and the local PC is powered on, the UCX-4x3-TPX-TX20 is switched to I4 and transmits the video to Monitor 1 through the receiver.

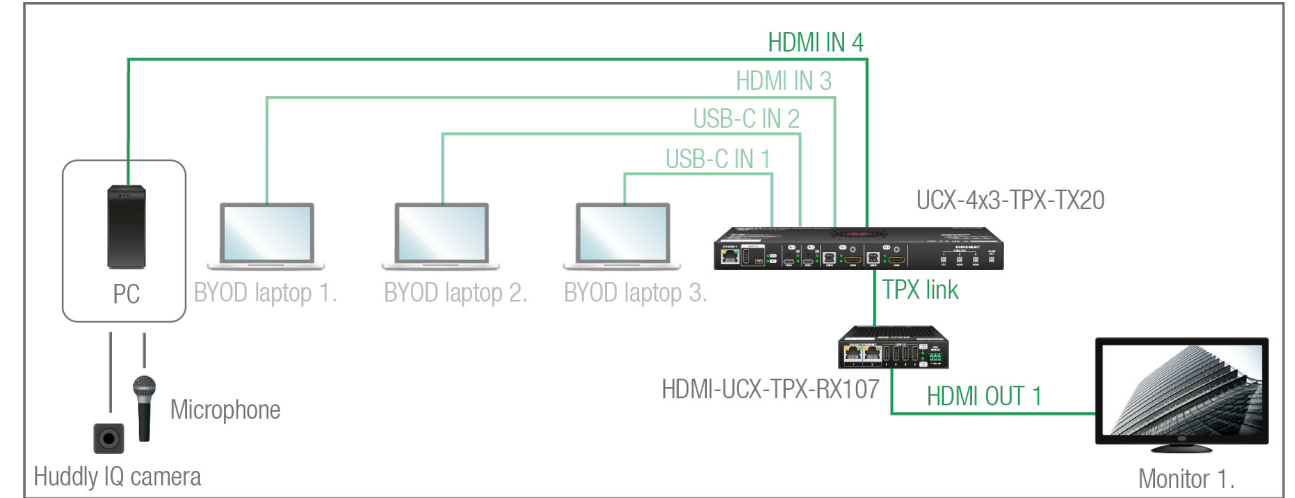

The individual input settings are the following:  
 HDMI OUT: I1 priority:1; I2 priority: disabled; I3 priority:2; I4 priority: disabled; I5 priority:3

**Automatic Input Selection - Example 3.**

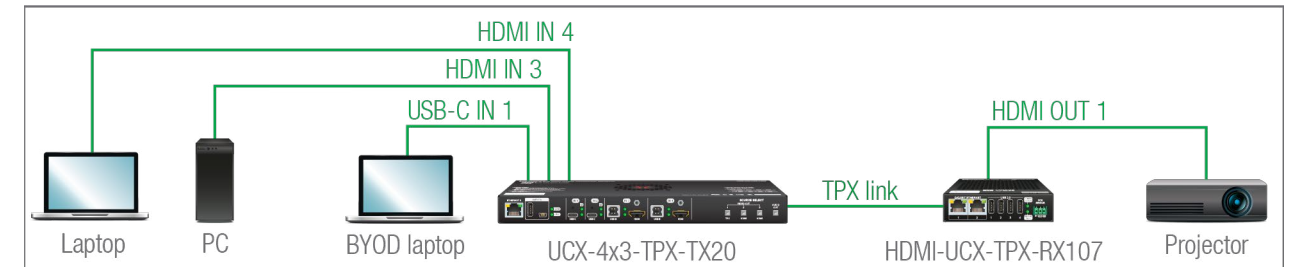

The laptop on HDMI IN 4 will be automatically switched to the HDMI output on the receiver if there is no other source connected to the switch. If the PC is powered on and has active video signal, the HDMI IN 3 will be switched to the HDMI output. If the BYOD Laptop is connected through the USB-C input 1, it will be switched to the HDMI output – independently of the presence of the other video signals.

Set the Autoselect mode to Last detect for HDMI OUT 1: The priorities are the following (the lowest number means the highest priority):

Source device	Input port	Priority
Laptop	I4 (HDMI IN 4)	3
PC	I3 (HDMI IN 3)	2
BYOD Laptop	I1 (USB-C IN 1)	1

Priorities can be set in Lightware Device Controller software, see the related settings in the [HDMI Video Output](#) section.

**Automatic Input Selection - Example 4.**

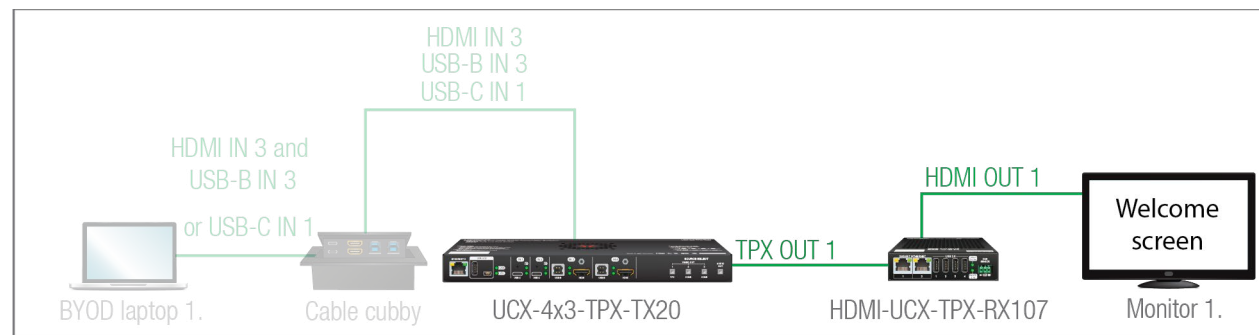

The Welcome screen appears on the Monitor 1. (O1) when no active source is connected. A presenter can choose what cable(s) are appropriate for their BYOD. Either a USB Type-C cable alone for both USB and Displayport, or one USB cable (USB-B or USB-C) for data and one HDMI cable for video can be used. The UCX-4x3-TPX-TX20 will switch both USB and video layers accordingly. Cable cubby for BYOD #1 has three cables connecting to USB-C (IN1), USB-B (IN3), HDMI (IN3).

**Case 1.**

When the BYOD laptop uses HDMI for video and USB-B for data.

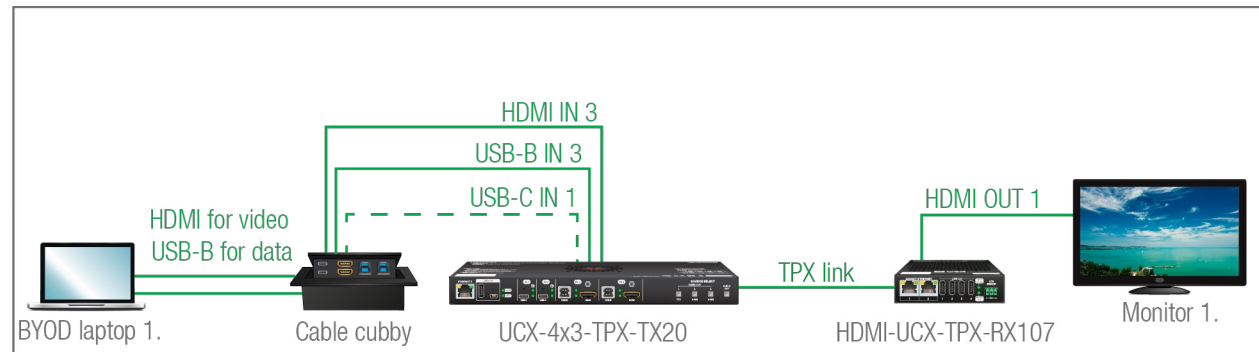

**Case 2.**

When the BYOD laptop uses HDMI for video and USB-C for data.

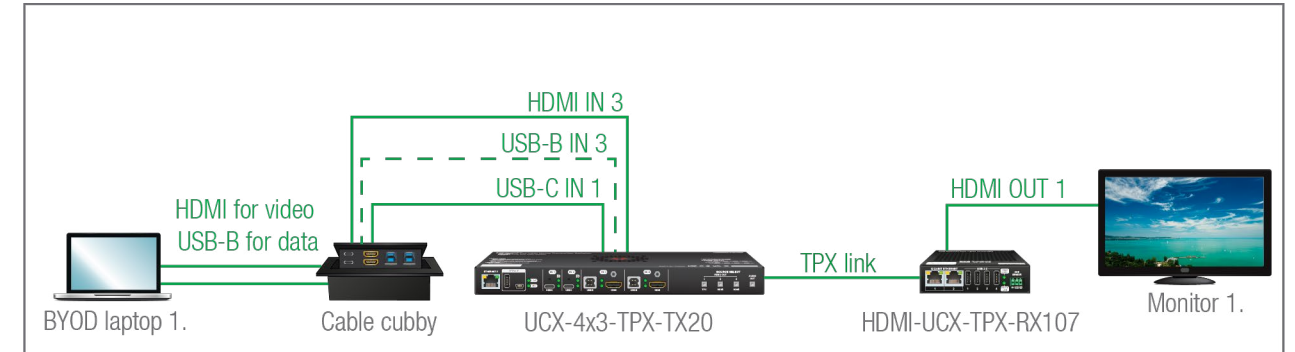

**Case 3.**

When the BYOD laptop uses USB-C for video and data and USB-C for data.

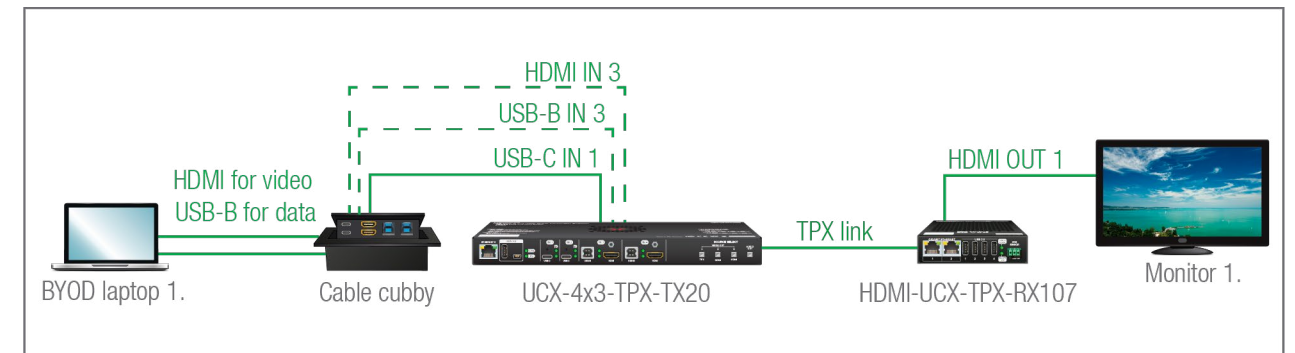

The individual input settings are the following:

**Video**

O1: Last detect; I1 priority:1; I2: disabled; I3 priority:1; I4: disabled; I5 priority:2

**ATTENTION!** Take care that the O2 video is not switched to I5 because of the crosspoint limitation: I1 and I5 ports are not available at the same time, only one of them can be selected to any output.

**USB**

H1: Last detect, U1 priority:1; U2 priority:1; U3 priority:1; U4 priority:1

## 5.5. Audio Interface

### Summary of Audio Ports

	Audio Outputs
	Analog audio de-embedding
	
	5-pole Phoenix® Combicon
UCX-4x3-TPX-TX20	✓
UCX-2x1-TPX-TX20	✓
UCX-3x3-TPX-RX20	✓
HDMI-UCX-TPX-RX107	✓

### Video and Audio Port Diagram (UCX-4x3-TPX-TX20)

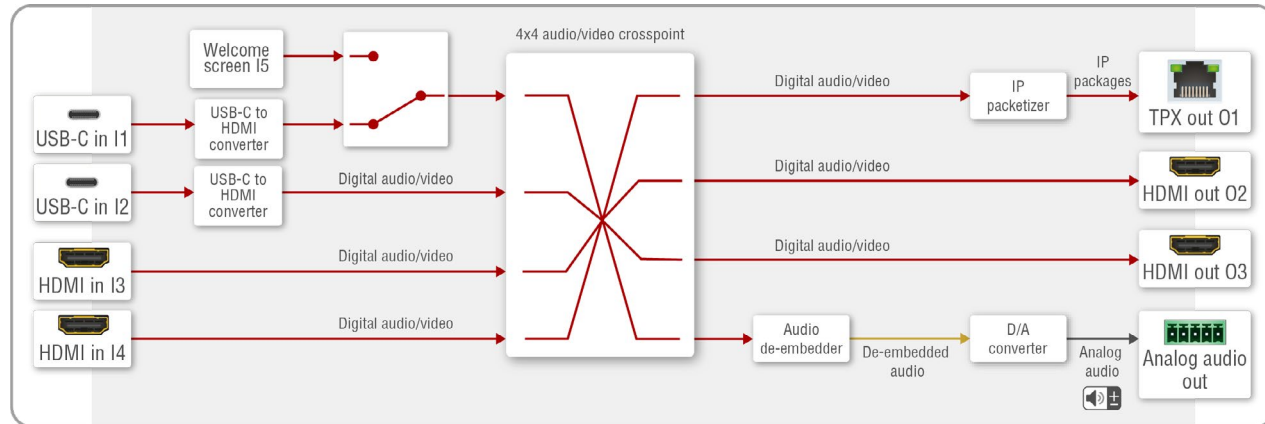

### Video and Audio Port Diagram (UCX-3x3-TPX-RX20)

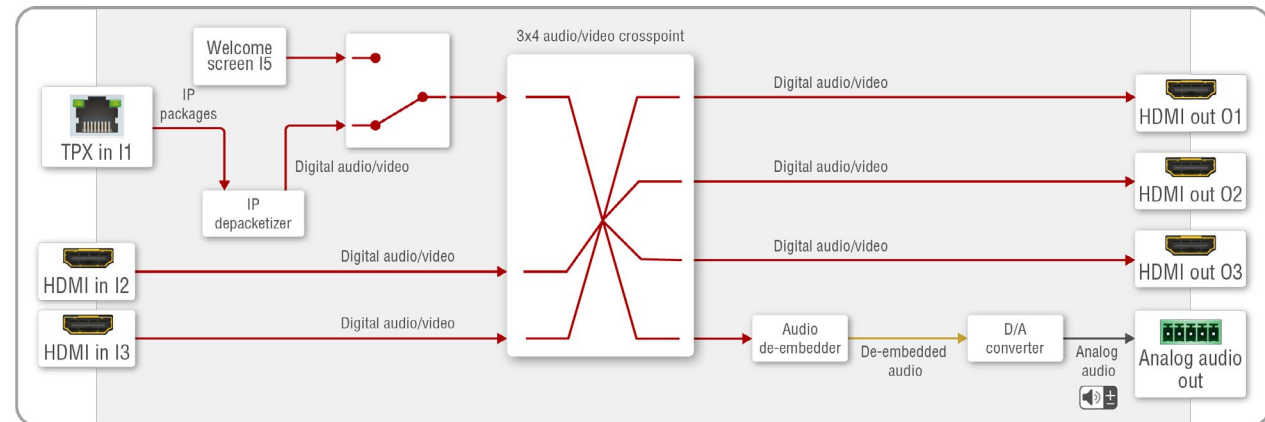

### Video and Audio Port Diagram (HDMI-UCX-TPX-RX107)

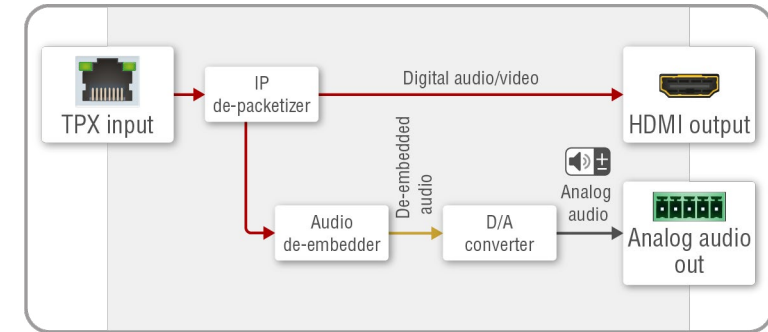

INFO: The -LCC models have the same values as non-LCC models.

### 5.5.1. Analog Audio Interface







The device can receive embedded audio signal on the HDMI or USB-C inputs.

The switcher transmitter has a built-in audio de-embedder, which means the device is able to de-embed audio from its video ports to its analog audio output port.

**ATTENTION!** Audio can not be de-embedded from I1 to O3 as long as I5 is in use. This is due to the mutually exclusive operation of I1 and I5 ports. Embedded audio signal present will read false in the case described above.

## 5.6. Ethernet Interface

### Summary of Ethernet ports

	USB-C	Ethernet 1	Ethernet 2	Ethernet 3	Gigabit Ethernet	TPX
						
UCX-4x3-TPX-TX20	2x	✓	✓	✓	-	✓
UCX-2x1-TPX-TX20	1x	✓	✓	✓	-	✓
UCX-3x3-TPX-RX20	-	✓	✓	✓	-	✓
HDMI-UCX-TPX-RX107	-	-	-	-	2x	✓

INFO: The -LCC models have the same values as non-LCC models.

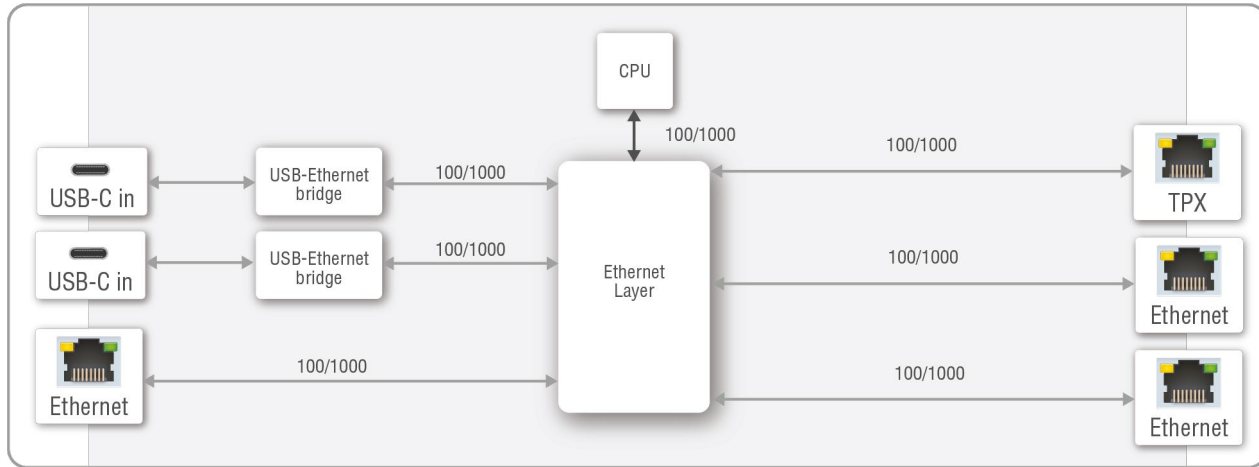
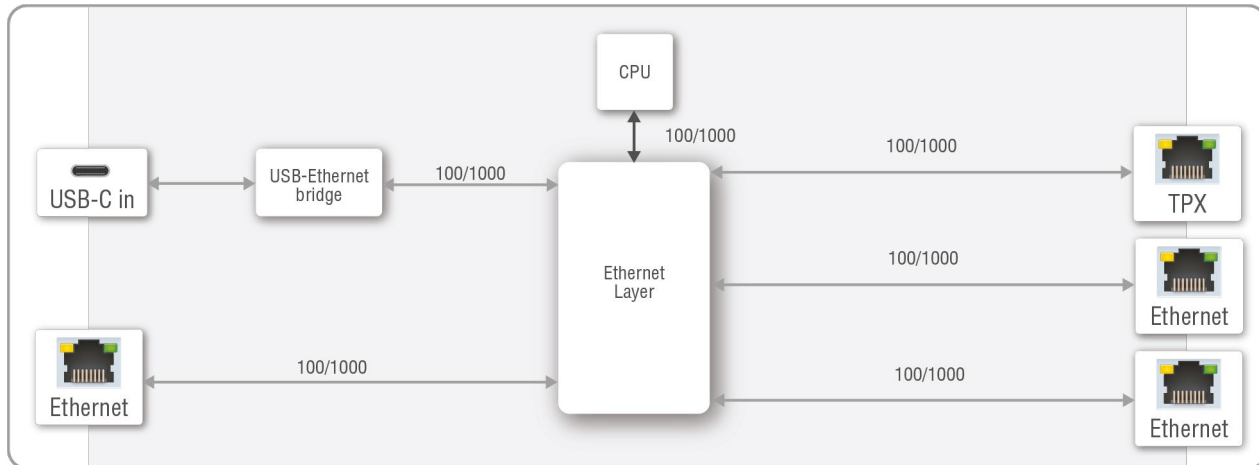
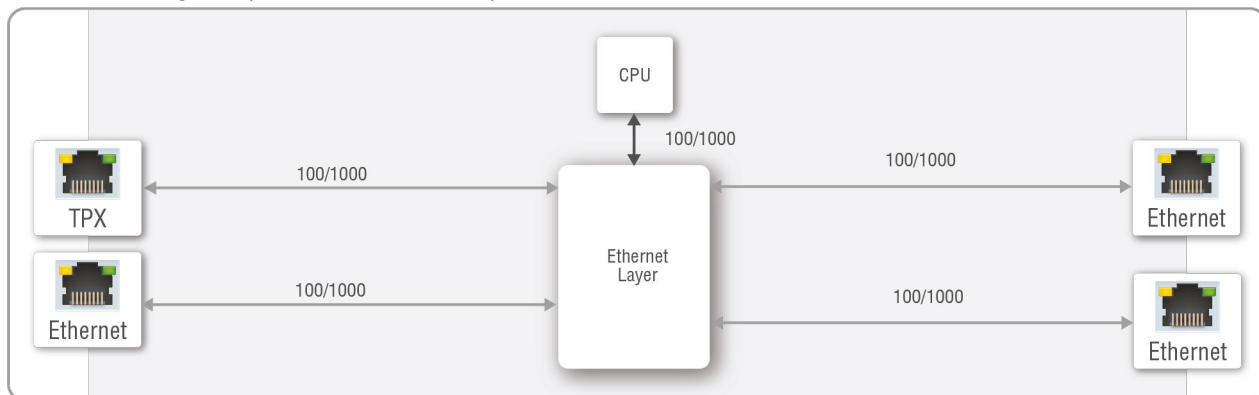

**Ethernet Port Diagram (UCX-4x3-TPX-TX20)****Ethernet Port Diagram (UCX-2x1-TPX-TX20)****Ethernet Port Diagram (UCX-3x3-TPX-RX20)**

The device can be controlled via Ethernet (standard RJ45 connector). This interface supports:

- Configuration of the device with Lightware Device Controller. For more information about the LDC, see the [Software Control Options](#) section.
- Control of the Lightware devices with LW3 command protocols. See more details about the Lightware protocol in the [LW3 Programmers' Reference](#) section.
- Establishing the connection to the Lightware Device Updater v2 software and performing Firmware Update.
- Creation of a local network, passthrough the Ethernet traffic.
- The switcher provides WS/WSS services on its 80 (for WS) and 443 (for WSS) ports to control the device with LW3 protocol commands. For more details, see the [WebSocket Service \(WS, WSS\)](#) section.
- REST API interface is also designed for control UCX switcher. See more details in the [Lightware REST API Reference](#) section.

**USB- Ethernet Bridge**

The built-in USB- Ethernet bridge provides Ethernet for the USB-C connection through the USB-2.0 layer.

**DIFFERENCE:** The UCX-3x3-TPX-RX20 and HDMI-UCX-TPX-RX107 models do not have USB-C ports.

**System Requirements of USB- Ethernet Bridge**

The built-in USB- Ethernet bridge operates as a third-party USB Ethernet hub.

- Windows and MacOS X operation systems handle it plug and play.

## 5.7. Lightware Advanced Room Automation (LARA)

Lightware Advanced Room Automation (LARA) is a future-proof room automation platform that enables controlling both Lightware and 3rd-party devices in a meeting room area and also accessing remote services over the network. LARA has an easy-to-use graphical interface that allows the integrators to set up and deploy their system and also helps the technicians and IT personnel to check the system status and diagnose possible errors. LARA comes with built-in touchscreen control support, where a fully customizable graphical interface can be provided to literally any modern touchscreen device.



LARA eliminates the need for an external controller unit or PC, as it is embedded into the Taurus UCX family. Because of the modular design, the integrators can build their system based on existing modules (drivers, touch screens, services and more) or create their own. Thanks to the approach of open source modules, the integrators can easily modify or extend the existing modules, or use them as a base for their new solutions.

With LARA, integrators can set up the behavior of the meeting room by creating rules and setting various parameters, there is an option to write codes. JavaScript is the most widespread language today, which has a steep learning curve and huge online community. By using the popular NodeJS engine, the integrators can rely on the public NPM repository (<http://www.npmjs.org>) and use the free packages available there.

We are working hard to release new functionalities regularly and make LARA more and more user-friendly.

### 5.7.1. Opening the LARA interface

**ATTENTION!** When connecting to a device, you will need the 443 port for HTTPS connection, and optionally the 6107 port for raw TCP connection and the 80 port for HTTP connection.

**Step 1.** Enable LARA in your device. Navigate to the Settings/Network tab. First set a password for the 'admin' user, then enable LARA via the checkbox.

**INFO:** As LARA is capable of running NodeJS scripts accessing your network, it is imperative to prevent open access that could be used by a malicious attacker.

**Step 2.** Open LARA in either of the following ways:

- Via the **Open LARA** button under the System tab in the LDC, or
- By typing `https://<ip_address>/lara` into the address field of your browser. Even though any modern browser should work, we recommend using the latest Chrome or Safari versions. If you don't know the IP address of your device, please use Lightware Device Controller to discover it on your local network.

LARA does not run by default, however, once it starts, it will remain running even after resetting the device or closing the browser, until it is stopped by the user. It can be disabled in the LDC software. Please be aware that calling factory reset will erase LARA configurations.

While a graphical interface is available for most of the general functions, LARA offers the option to use it with JavaScript codes for every step and modification for both basic and more advanced task creation. Wizard and JavaScript code usage can easily be combined for maximum efficiency.

#### Help

LARA offers a built-in help interface, which is available by clicking on the **Help** button near the top right corner. If you have active Internet connection, the [LARA User Manual](#) is available either via the QR code or the clickable link beneath it.

### 5.7.2. Running LARA

LARA uses modules and their instances as basic building blocks of a configuration.

#### Modules

Modules are software pieces that give a base to the processes in the LARA interface. There are five module categories available as follows:

- **Driver:** a module connected to a certain device in the network
- **Logic:** a module for organizing the other modules into a system
- **Userpanel:** provides a user interface for the end user (e.g. tabletop control)
- **Service:** a module connected to a certain service in the network (e.g. calendar services)
- **Script:** any custom module for a specific purpose

LARA modules have access to the devices' every port, connection interface and the entire parameter library of the LW3 tree.

There are several pre-made modules that can be found in LARA for quick and easy system setup. These modules can be found in the **Browse Modules** menu by clicking on the **Create New** button and choosing one of the options from the **Base modules** drop-down list.

- **Taurus/MMX2 driver** module - for controlling the device
- **Taurus/MMX2 CEC driver** module - for sending CEC messages via the HDMI ports
- **Generic LW3 driver** module - for controlling another Lightware device that supports LW3 protocol
- **Generic TCP/IP driver** module - for controlling any device that is available via TCP/IP connection
- **Cisco Webex script** module - integration with Cisco Webex supporting BYOD (Bring Your Own Device) functions
- **OCS sensor serial message script** module - for sending a serial message to a device (e.g. Display) if the Occupancy Sensor detects a signal
- **Generic REST Client driver** module: universal module for controlling third-party devices over HTTP(S) REST API (PUT, POST, GET, DELETE)
- **Signal present serial message script** module - for sending a serial message to a device (e.g. Display) if a video signal is detected on a port

#### Instances

Modules can be run as instances. Different parameters may be added to different instances for the same module to include every possible process in the desired system.

Instances can communicate with each other using **Events** and **Methods**.

**ATTENTION!** It is currently only possible to run all instances together, or run none of them.

#### Events

Every instance can emit Events when something happens. An event is always momentary, it will be emitted immediately when something triggers it. An event can be used by other logic or user panel instances, or even by the same instance itself.

## Methods

Methods are software pieces in any instance, which can be invoked (called) to initiate an activity in the associated room equipment.

## Rules

Rules allow setting up processes according to changes in the state of the device. A status change might dispatch an **Event**, which can trigger a rule. The rule will then be able to execute an **Action** according to the triggering Event. When defining a new rule, a triggering Event must be selected. In case of Logic and Userpanel modules any instance can be chosen as the source of the Event. In other cases only the given module's own Events may be selected.

Once an Event has been dispatched that triggered a rule, an Action will be launched. An Action may have an unlimited number of steps defined.

### 5.7.3. Downloading/Uploading a Configuration

The modules, or even the entire configuration can be downloaded to the computer as a .zip file, or a previously saved configuration can be uploaded to a device.

**ATTENTION!** If the links to methods/properties are compatible with other models within the UCX/MMX2 product family, the configuration will work without a problem. However, sometimes a simple fine tune in the LW3 path of the properties/methods is necessary.

In case of downloading (and later uploading) a configuration of the module, these files are contained within the .zip file.

### 5.7.4. Status Board

The Status board offers real-time information about the connected devices through all running instances as Status Indicators. Such information might include connection status, signal presence, or even parameter status tracking. The indicators may show either static or self-refreshing information based on the current states of the device.

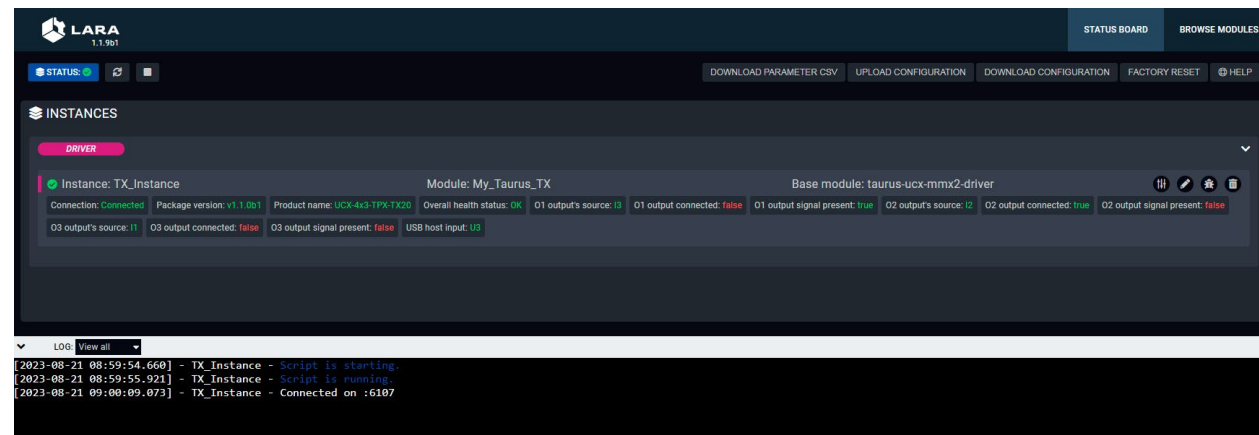

### 5.7.5. Touch Panel Support

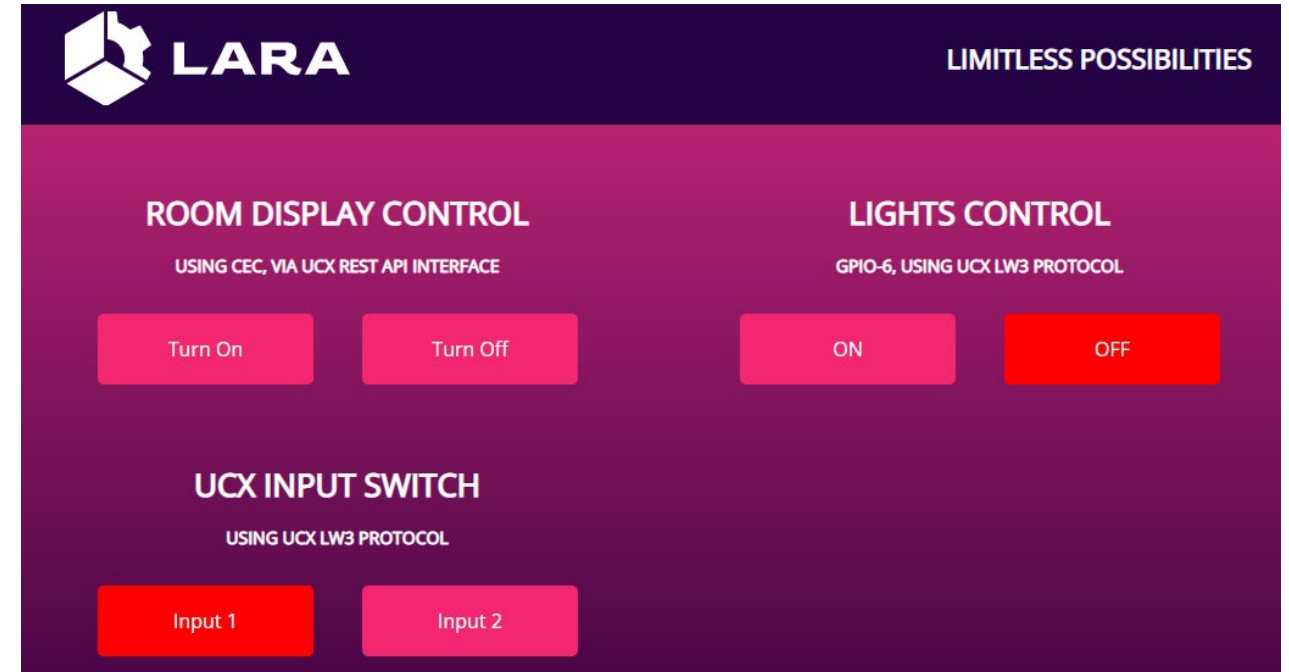

LARA offers support for any touch panel device that has a browser installed on it. With the use of Userpanel modules, you can easily upload project specific HTML/CSS/JS files to your devices, and edit or change them in LARA in real time. There is a Content option under a Userpanel module for the purpose of uploading and editing these files. It is also possible to create folders and subfolders for easy organization. Uploading can be done by dragging and dropping the files into the content section.

For proper operation, in the HTML code a unique ID shall be assigned to every HTML element where LARA interaction is required.

For more information, sample configurations and training materials, please visit [lightware.com/lara](https://lightware.com/lara) or take a look at the [LARA User Manual](#).

## 5.8. Basic Network Security

These basic network security improvements help to prevent unauthorized access to the UCX series switchers:

- Disable Ethernet Ports
- Disable Network Services
- Basic Authentication
- Encryption (HTTPS,WSS)

The following table summarizes the ports, protocols, features and the security options.

Port number	Protocol	Function	Affected software	Port disable option	Encryption	Authentication	Other features
80	TCP	HTTP port (LW3 over WS, REST API, LARA user panels)	LDC, LDU2	✓	✗	✓	FW update, Welcome Screen image upload, Log files, User Scripts Serial messaging
443	TCP	HTTPS port (LW3 over WSS, REST API, LARA management GUI)	LDC, LDU2	✓	✓	✓	
6107	TCP	LW3 protocol	LDC	✓	✗	✓	
8001, 8002; 8003 (RX)	TCP	Serial over IP (RS-232)	-	✓	✗	✗	
224.0.0.251: 5353	UDP	mDNS / Bonjour (Device Discovery)	LDC, LDU2	✗	✗	✗	
230.76.87.82: 37421	UDP	Remote IP	LDC, LDU2	✗	✗	✗	

**INFO:** The ports are necessary to be passed via a network switch/firewall for proper operation between the device and the softwares.

**ATTENTION!** Be careful when combining the security functions; improper settings may cause malfunction.

### 5.8.1. Disable Ethernet Ports

Internal Ethernet connections can be limited by enabling/disabling the Ethernet ports depending on the actual system configuration (e.g. Ethernet layer of the USB Type-C port can be disabled if necessary).

### 5.8.2. HTTP/HTTPS

UCX series switcher transmitter provides HTTP/HTTPS server services on its 80 (for HTTP) and 443 (for HTTPS) ports. It makes it possible to use the following services via HTTP/HTTPS:

- LW3 over WebSocket (WS, WSS) for LW3 protocol or using LDC for device control
- REST API for device control
- Serial message sending with REST API
- Firmware update
- Uploading WelcomeScreen image
- LARA interface
- Downloading logfiles from the device

**ATTENTION!** LARA management GUI is only available through HTTPS and it is password-protected.

#### Basic Authentication

To limit user access for HTTP/HTTPS server services, basic authentication can be turned on for the ports 80 and 443 separately.

**ATTENTION!** Authentication feature in UCX-TPX series is not equal to the Cleartext login feature in the Advanced Control Pack v3 of the TPS family extenders.

The picture below illustrates the successful authentication process:

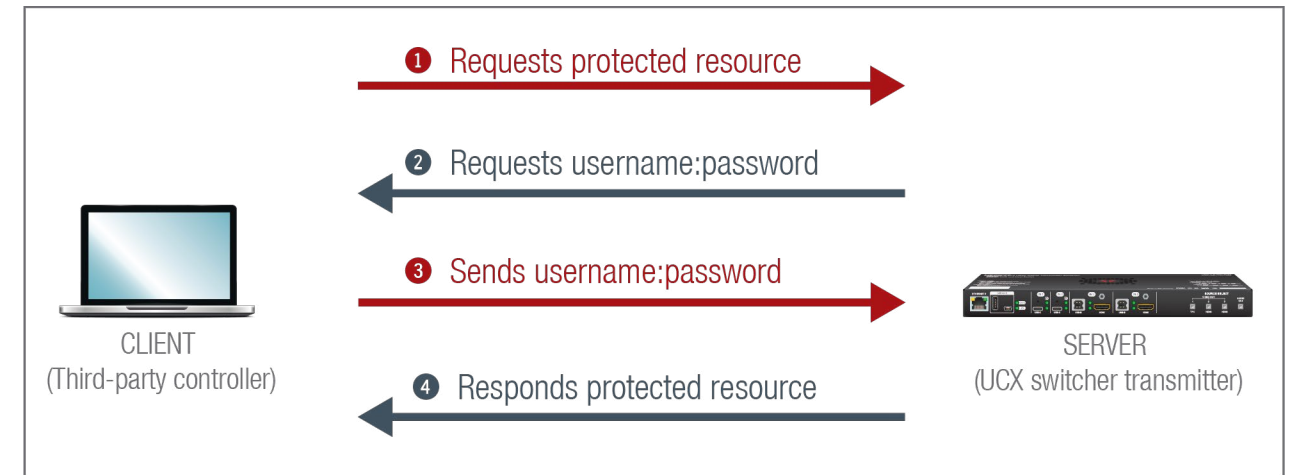

**User**

- The switcher can manage one user (with fixed username: admin) with full access.

**Password**

- No password is set by default, the authentication can be enabled after setting a password. The old password is required when password is changed.
- The password must be at least 10 characters long, and any UTF-8 character is allowed.
- From firmware version v1.8.0, password history is maintained in the web authentication, not allowing for the last 10 passwords to be set again.
- The device does not store the password string, so it can not be queried.
- The password can be reset by calling factory defaults ([Reset to Factory Default Settings](#)).

Follow the instructions to set the authentication:

- Step 1.** Set the password with Lightware Device Controller software ([Network](#)) or REST API command ([Setting a Password for Authentication](#)).
- Step 2.** Enable the authentication on the chosen port (HTTP: 80 or HTTPS: 443) with the Lightware Device Controller software ([Network](#)) or LW3 protocol command ([Enabling the Authentication](#)).
- Step 3.** Restart network services.

**ATTENTION!** The password will not be encrypted by this authentication mode, it remains accessible when the communication happens on HTTP.

**5.8.3. Encryption (HTTPS, WSS)**

HTTP protocol uses clear text format for data transport. This method allows a third-party to listen in and eavesdrop on the transferred information.

**HTTP request-response**

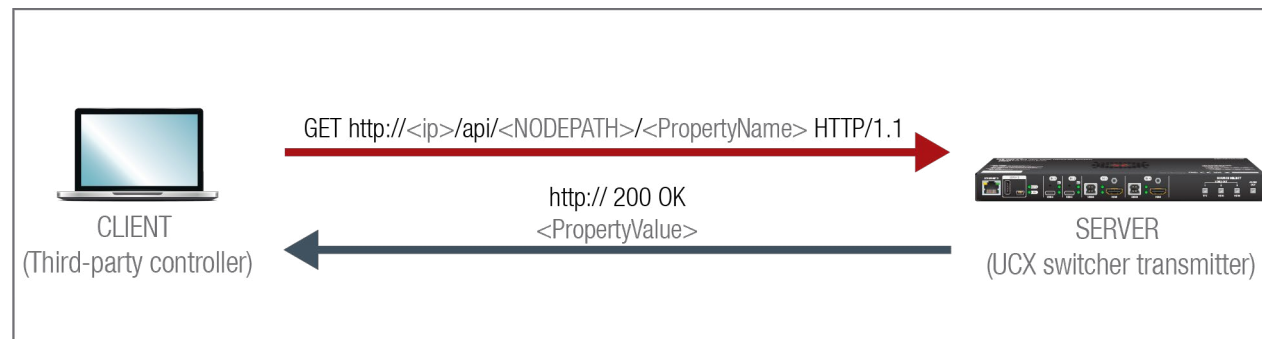

To ensure the secure data transmission, the HTTP port (80) can be disabled, and the all the information can be transferred via HTTPS (443 port). HTTPS protocol encrypts the clear text, so it becomes incomprehensible for a third-party and keeps the data secure.

**HTTPS request-response**

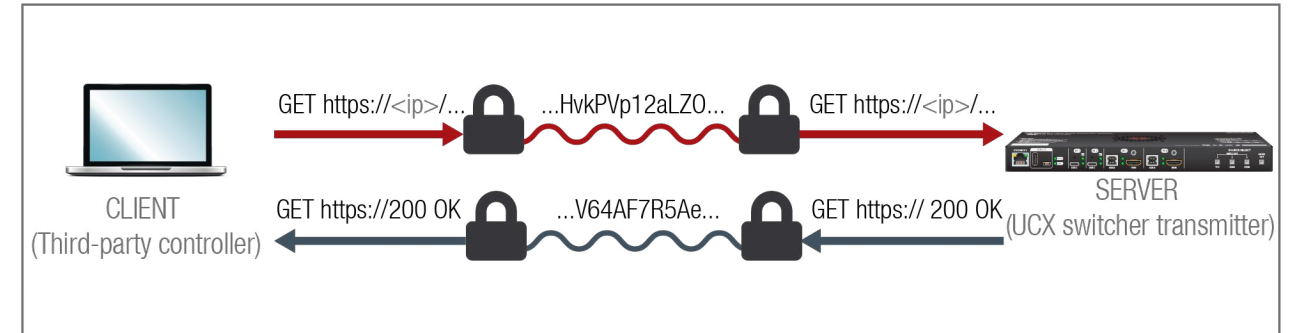

The same services are available on HTTPS as HTTP (for the detailed service list, see the [HTTP/HTTPS](#) section).

- The UCX series switcher transmitter generates a self-signed certificate, so the user does not have to deal with the configuration.
- SSL certificates can also be uploaded into the device ([Certificate Management](#)).
- A new certificate is generated after hostname changing or restoring the factory default settings.
- Please ensure proper UCX time and date setting in UCX, because it affects the self-signed certificate (SSL) generation when using WSS or HTTPS. Improper time and date setting may lead to certificate rejection.

**ATTENTION!** HTTPS does not guarantee that the communication is secure. Make sure that the client communicates with the server directly, without any third-party element in the communication route (Man-in-the-middle attack).

**Basic Security System Example**

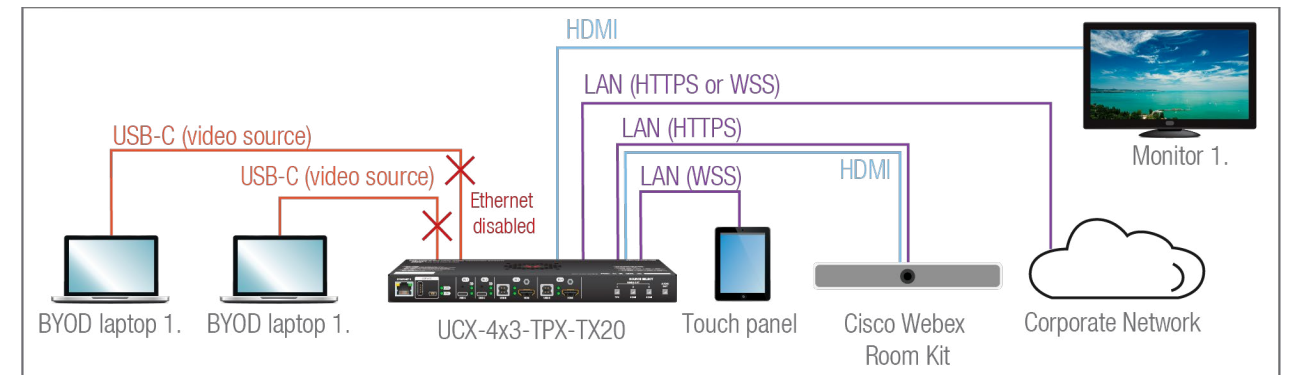

To keep the system protected, the unsecured ports should be disabled and data traffic should be managed by secured channels.

**Step 1. Disable the Ethernet layer of the USB-C ports towards the laptops. The video and USB data transmission still work.**

The setting is available in the following ways:

- Lightware REST API HTTP posts (see the details in the [Network](#) section)
- LW3 protocol commands (see the details in the [Enabling/Disabling the Ethernet Port](#) section)

**Step 2. Disable the HTTP port (80) and use HTTPS (443) instead.**

The setting is available in the following ways:

- Lightware REST API HTTP posts (see the details in the [Enabling/Disabling the Network Service Port](#) section).
- LW3 protocol commands (see the details in the [Enabling/Disabling the Service Port](#) section).

**Step 3. Set the password and enable the authentication.**

The username is always fix (admin) and the password has to be set before authentication is enabled. The setting is available in the following ways:

- Lightware Device Controller software (see the details in the [Network](#) section)
- Lightware REST API HTTP posts (see the details in the [Setting a Password for Authentication](#) and the [Enabling the Authentication](#) section).

**Step 4. Disable 6107 port, use Lightware REST API HTTPS (443 port) or WSS for LW3 protocol to control the device.**

The setting is available in the following ways:

- Lightware REST API HTTP posts (see the details in the [Enabling/Disabling the Network Service Port](#) section).
- LW3 protocol commands (see the details in the [Enabling/Disabling the Service Port](#) section).

**Step 5. Disable the remaining unsecured Serial over IP ports (8001 and 8002).**

The setting is available in the following ways:

- Lightware REST API HTTP posts (see the details in the [Enabling/Disabling the Network Service Port](#) section).
- LW3 protocol commands (see the details in the [Enabling/Disabling the Service Port](#) section).

## 5.9. 802.1x Authentication

**ATTENTION!** Only the UXC-4x3-TPX-TX20, UCX-2x1-TPX-TX20 and UCX-3x3-TPX-RX20 models are capable of this function. The HDMI-UCX-TPX-RX107 model will receive it in a later update.

802.1x is a server-based port authentication protocol that restricts unauthorized clients from accessing a LAN through a public port. Three parties make up the most basic setup of 802.1x: a supplicant (client device), an authenticator (Ethernet switch) and an authentication server. Before the device is permitted access to the network, port communication is restricted to Extensible Authentication Protocol over LAN (EAPOL) traffic.

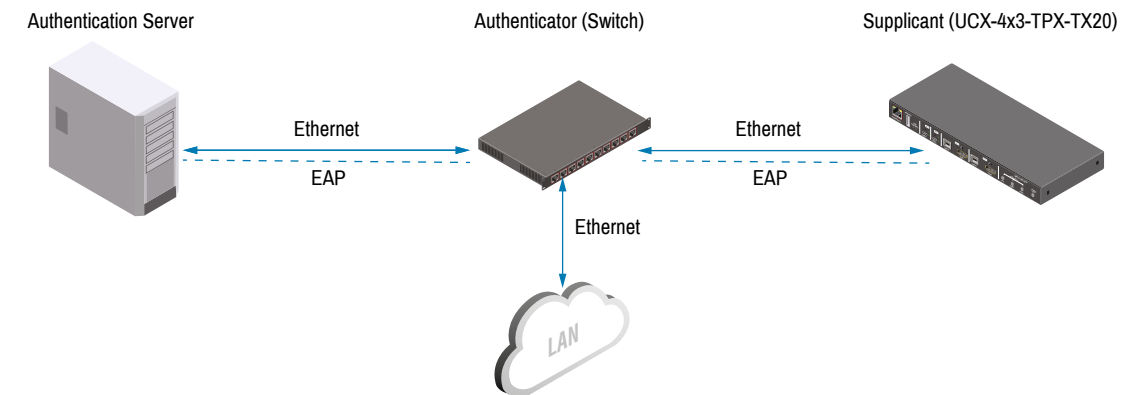

After the device passes the authentication process, the authentication server notifies the switch, allowing the client to access the LAN.

There are two available methods for 802.1x authentication in the UCX-TPX series devices:

- **EAP-MD5:** This commonly used method authenticates by verifying MD5 (Message Digest 5) hash of a user password.
- **EAP-TLS:** This method utilizes Public Key Infrastructure to authenticate with an authentication server. To communicate with the server, a certification authority (CA) certificate and a client-side certificate that is signed by a known certification authority are needed.

**DIFFERENCE:** From firmware version v1.9.0, EAP-MD5 authentication is unavailable.

The UCX itself can act as a supplicant, but also as a route through which a BYOD device can reach the authenticator as a supplicant.

**ATTENTION!** This method authenticates the UCX device, not the BYOD connected to the UCX! If you only want to authenticate the connected BYOD device and not the UCX, you do not need to activate 802.1x authentication in the UCX device.

**INFO:** When updating the firmware of the UCX-TPX series device, sensitive information (passwords, keys etc.) on the authentication will not be downloaded into the backup file, but it will be retained in the device during the update.

## 5.10. Advanced Ethernet Security

**DIFFERENCE:** The advanced ethernet security feature is available only from FW package v1.6.0.

This feature is a port-based VLAN setting, which allows the user to decide which network(s) the USB-C ports are connected to, and thus which network(s) the connected devices can use. This way the connected devices can be separated from the corporate network, increasing network security.

There are two options available, which are the following:

- **Transparent:** this is the default mode, with the network openly used by Taurus and the BYOD devices. If you want to authenticate the connected BYOD through 802.1x, this option is not recommended.
- **Custom:** the setting of any Ethernet port differs from the default property

**INFO:** Only one mode can be active at the same time.

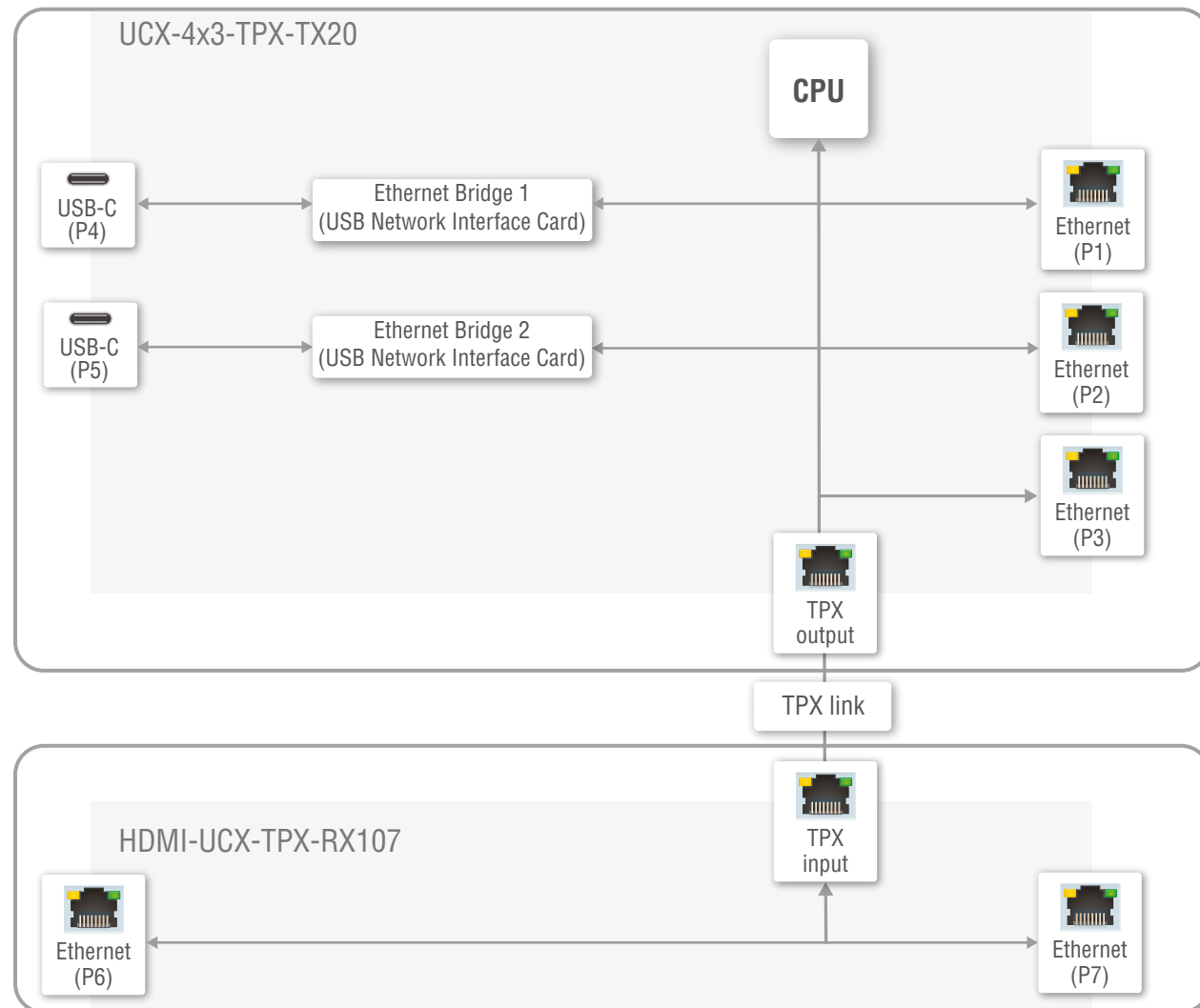

Transparent VLAN preset with UCX-4x3-TPX-TX20 and HDMI-UCX-TPX-RX107

### 5.10.1. Network Separation

**DIFFERENCE:** From FW version v1.13.0b3, Management network is introduced in UCX-TPX-TX devices.

The matrix switch supports two VLANs: the Default/AV network and the Management network. However, due to a topology limitation, both VLANs may currently operate under the same MAC address. This setup can lead to connectivity issues such as:

- Packet Misrouting: Network traffic may be sent to the incorrect VLAN.
- Loop and Congestion: Duplicate MAC addresses can cause loops or broadcast storms.
- Device Inaccessibility: Difficulty in managing devices or maintaining network reliability.

To ensure stable operation and avoid connectivity conflicts, follow this practice:

On the switch, disable any ports or VLANs that are not actively in use. This reduces the chance of unintended traffic crossing between VLANs.

**DEFINITION:** Management network is a VLAN Membership setting that creates an Ethernet port that can be used to only connect to the CPU for controlling and updating purposes.

**INFO:** The illustrations have been simplified for easier understanding. Please see the full port layouts in the Ethernet Interface section.

#### Example Scenario

Both the TX and the RX are connected to the Corporate network through the Management network, and to each other through the Default/AV network via the TPX ports. In this case the switches will see the same MAC addresses on both networks, and would be unable to tell which network to route to a MAC address.

One of the endpoints must be disconnected from the Management network in order for the system to work.

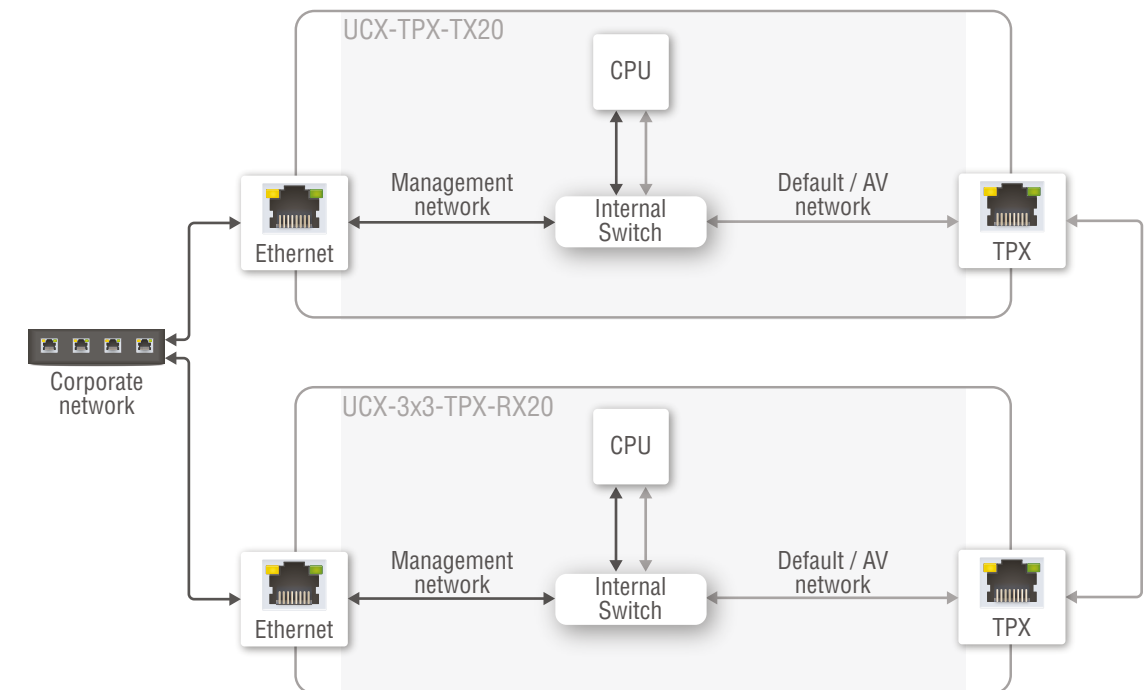

**Switch Restrictions - One UCX-TPX-TX device**

If the networks are only separated via VLANs, but not outer switches, the switch inside the transmitter will be unable to tell which VLAN to route packets to. To solve this, make sure to connect the ports of the separate networks to physically separate switches.

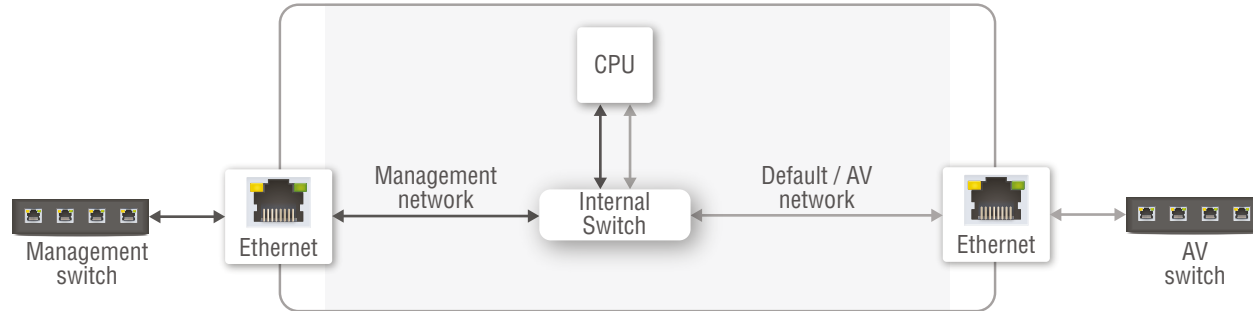

**Switch Restrictions - Several UCX-TPX-TX devices**

The system can only work properly if the transmitters are only connected to each other through a switch on the management network. If they are also connected to each other through a switch on the Default/AV network at the same time, the switches will be unable to tell which network to route to a MAC address.

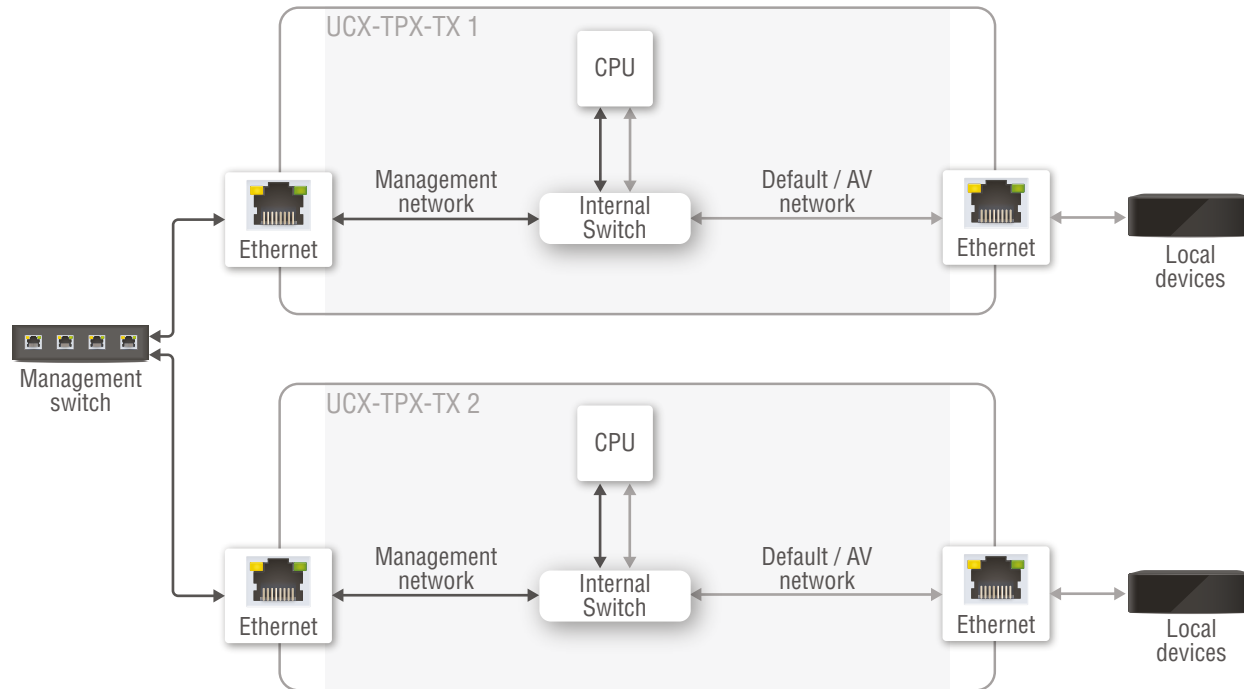

**Update Restrictions - UCX-TPX-TX with HDMI-UCX-TPX-RX107**

The transmitter is connected to the Management network, and the receiver is connected to the transmitter through the Default/AV network. In this case, updating the receiver remotely is not possible. Either disabling the network separation or a physical connection to the RX is required for the update.

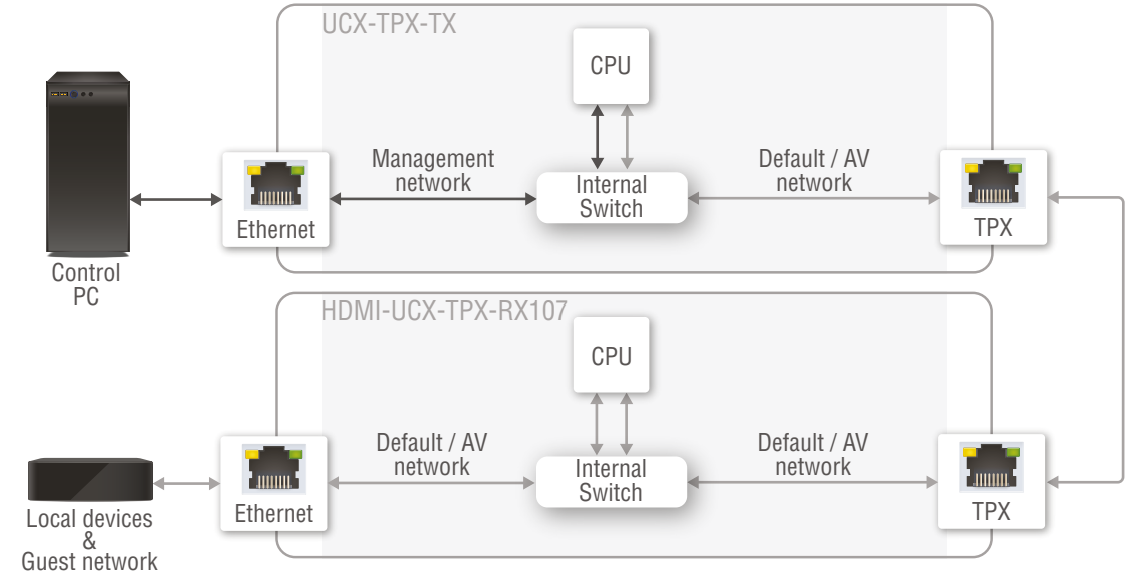

**Update Restrictions - UCX-TPX-TX with UCX-3x3-TPX-RX20**

The endpoints are connected to each other through the Default/AV network, and either of them can be connected to the Management network, **but only one at a time**. In this case, remotely updating the endpoint **not** connected to the Management network is not possible - a physical connection to the remote endpoint is required for the update, similarly to the previous case.

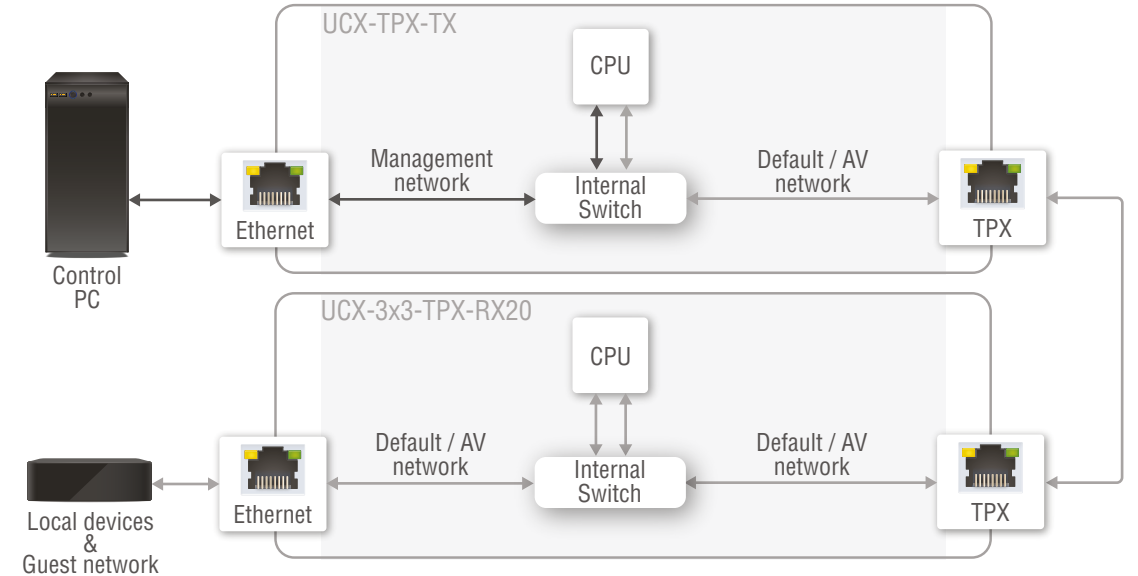



### 5.11. Lightware Crypto Core

**DIFFERENCE:** This feature is only available for the -LCC models of the UCX-TPX family.

Lightware Crypto Core is a standards-based cryptographic engine for embedded Linux systems. The module delivers core cryptographic functions to the embedded systems of Taurus product family's hardware devices and features robust algorithm support.

#fips #new

It also offloads functions for secure key management, data integrity, data at rest encryption, and secure communications to a trusted implementation.

Lightware Crypto Core is Lightware's own FIPS 140-2-validated, Level 1-certified, cryptographic software module that is integrated into UCX-TPX products.



### 5.12. WebSocket Service (WS, WSS)

UCX series switcher transmitter provides WS/WSS services on its 80 (for WS) and 443 (for WSS) ports to control the device with LW3 protocol commands.

The UCX series switcher transmitter can manage 18 connected clients in total simultaneously for WS (80), WSS (443) and LW3 (6107) ports.

The WebSocket connection is built up by HTTP handshake. After the connection is established, communication switches to a bi-directional WebSocket protocol for LW3 communication.

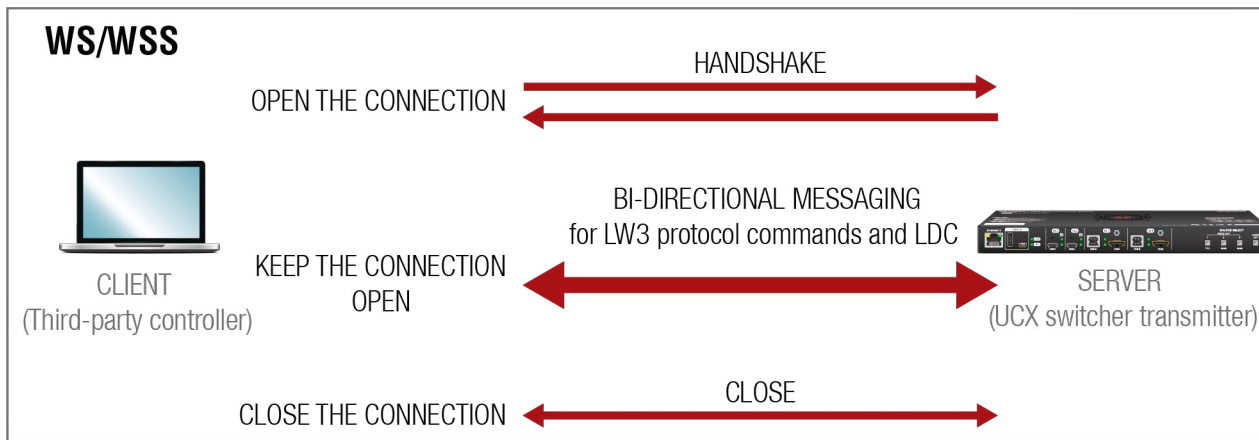

The main difference between HTTP and WS communication process is that HTTP closes the connection between the client and the server after one request-response pair, while WebSocket keeps the connection open. This feature allows real-time communication such as **controlling the device with LW3 protocol commands**. The WS functions are also available via WebSocket Secure (WSS).

### 5.13. Bulk Device Management

It is possible to configure several devices at once with the Bulk Device Management tool. This feature can be accessed by clicking on the **Tools** button in the bottom left corner of the Device Discovery window of the LDC and choosing the Bulk Management option.

See the [Bulk Device Management](#) section for more details.

#### 5.13.1. Network Settings

This function makes it possible to change and adjust the network settings of several devices at once (unique settings for each device), without having to set them at each device one by one. A .csv file can be created containing the list and desired settings of the devices and it can be uploaded into the LDC to be applied to the devices quickly.

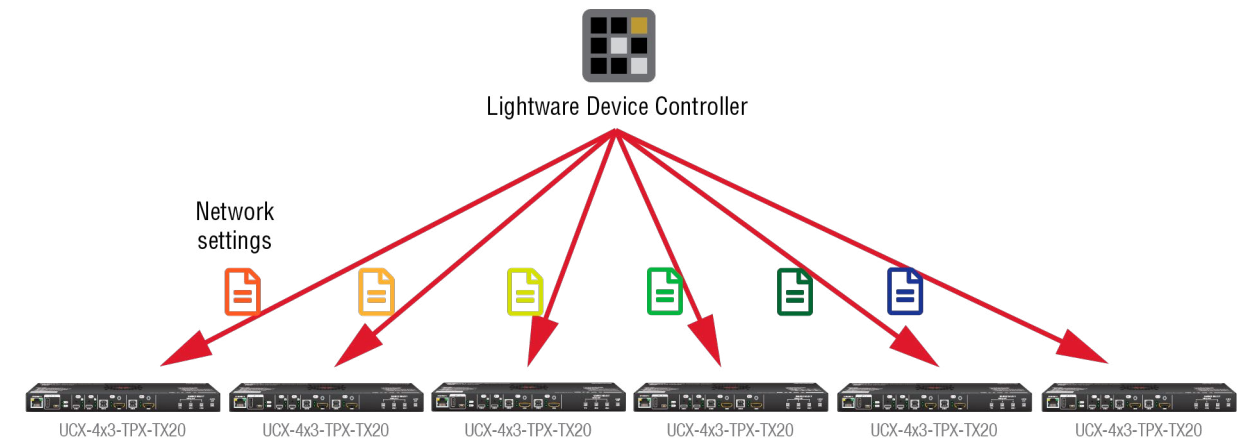

#### 5.13.2. Device Configuration

Here you can choose the devices that need to be configured, and upload a previously saved configuration to all of them at once. This is a helpful tool for quick and easy reconfiguration of the devices after a firmware update. This function allows uploading configurations to devices with the same firmware version, without changing their network settings.

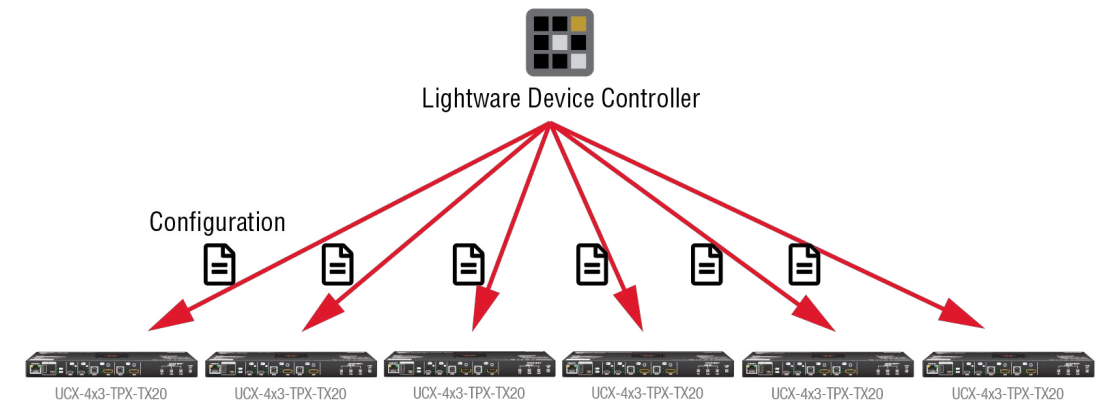

### 5.14. Serial Interface

Serial data communication can be established via the local RS-232 port (Phoenix® connector).

#### Summary of Serial Ports

	RS-232
	
UCX-4x3-TPX-TX20	2x
UCX-2x1-TPX-TX20	1x
UCX-3x3-TPX-RX20	2x
HDMI-UCX-TPX-RX107	1x

INFO: The -LCC models have the same values as non-LCC models.

#### 5.14.1. Serial Port Diagram

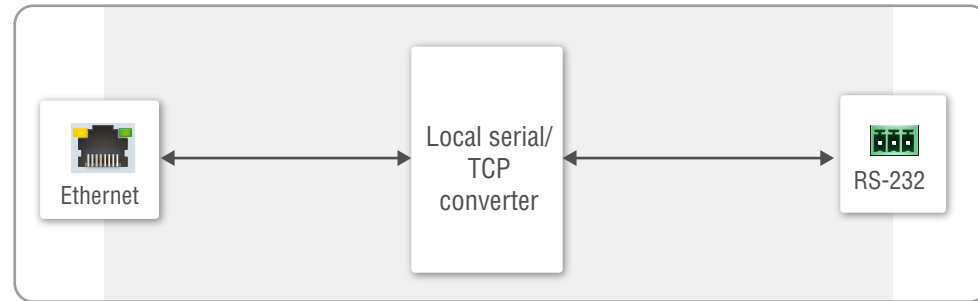

The UCX switcher extenders work as an RS-232 bi-directional converter. The TCP signal is converted to RS-232 data and vice versa. TCP/IP port numbers are defined for serial ports (8001, 8002) for this purpose. If a command is coming from the Ethernet interface that is addressed to the port no. 8001, it will be transmitted to the Tx pin of the local RS-232 port (P1). That works in the opposite direction too, and the method is the same on the serial interface of the Ethernet port as well, but the serial message will be transmitted to all opened TCP sockets (if the TCP connection closed meanwhile, the message will not be transmitted). It can handle a maximum of 20 connections at the same time.

**Disabling Serial over IP** function disconnects the Serial/TCP converter from the Ethernet layer and the serial data won't be transmitted to the Ethernet network. This setting is available in the Lightware Device Controller software (in the Settings menu, [Network](#) tab) or with REST API command ([Enabling/Disabling the Network Service Port](#)).

The extenders can manage a maximum of 20 connected clients at the same time for each serial port.

#### Message Sending Function

Message sending function allows RS-232 command sending to a third-party (or a Lightware) device from the UCX-TPX series. Any format is acceptable (text, binary, hexadecimal, etc.), maximum message size is 100Kb. Escaping is unnecessary.

Serial message sending is possible by using HTTP Post with Lightware REST API.

- ➔ header: POST: http://<ip>/api/V1/MEDIA/SERIAL/<serial\_port>/send-HTTP/1.1
- ➔ body: <message>

<serial\_port> is P1 or P2.

The MP1 (CPU) is available over REST API interface. The MP1 (CPU) sends the message via the serial port to a third-party (or a Lightware) device. This is a one-way communication, the response will not be interpreted by the CPU. Consider using Serial over IP function instead of listening to a serial device.

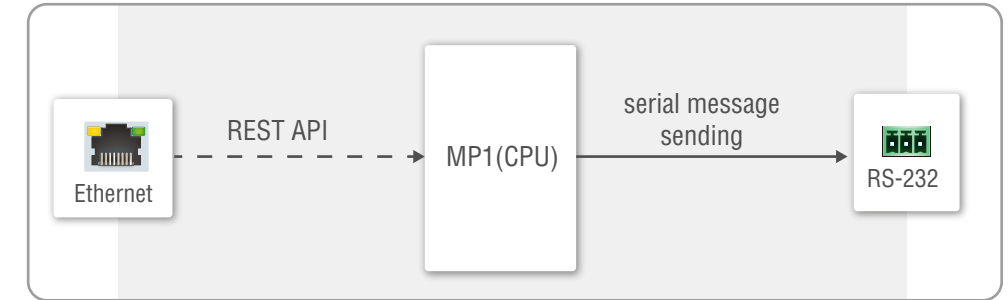

For more details about the Lightware REST API, see the [Lightware REST API Reference](#) chapter.

INFO: Taurus can receive a serial message in a special way. When a message is sent from the Taurus, the response from the connected device is accepted within 100 ms. The communication is closed after that time interval.

#### Serial Options - Example

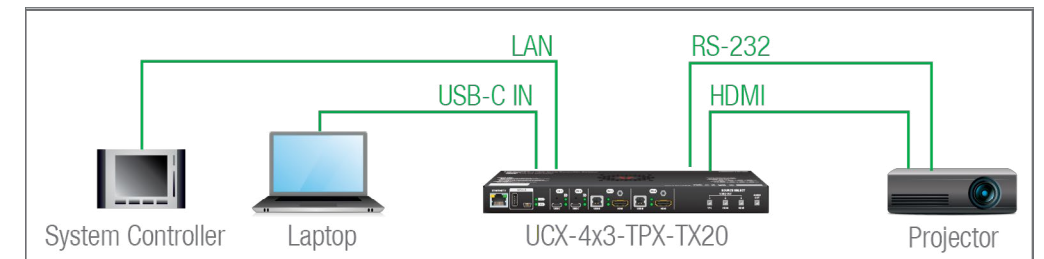

#### External Controller Concept

The projector is turned on and off by the external System Controller. The **System controller** has an internal REST API client, which is connected to the UCX switcher transmitter. It sends a HTTP POST to the **UCX-4x3-TPX-TX20**. The **Switcher transmitter** sends a serial message over the P1 port to the **Projector**.

**Security:** When interpreting of the response from the projector is necessary, serial over IP port (8001 or 8002) can be enabled, in this case, the 8001 or 8002 ports are available from other devices too, and it makes the system unsecured.

### 5.15. GPIO Interface

The General Purpose Input/Output (GPIO) port is a multifunctional input/output interface to control the switcher transmitter or third-party devices and peripherals. You can establish the connection between the controller/controllable device and the switcher transmitter via the 8-pole Phoenix connector. The direction of the six pins is configurable independently from each other.

#### GPIO Options - Example

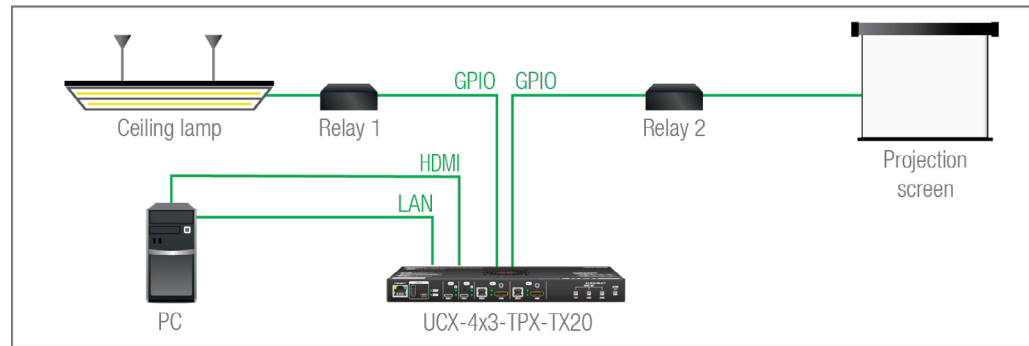

The ceiling lamp is turned off by Relay 1 and the projection screen is rolled down by Relay 2. Both relays are controlled by the GPIO port.

When the PC starts to play the video presentation, the signal is received over the HDMI input, so the GPIO pins send a signal to Relay 1 to open, which results in the lights being turned off. Furthermore, the GPIO pins also send a signal to Relay 2 to close and the projection screen is rolled down. When the presentation ends, signal ceases on the HDMI input, so the GPIO pins send a signal to Relay 1 to close, which results in the lights being turned on, and send a signal to Relay 2 to open, so the projection screen returns to its enclosure.

**ATTENTION!** Please always check the electrical parameters of the devices that you want to control. The maximum current of one GPIO pin is 30 mA, the maximum total current for the six pins is 180 mA.

### 5.16. OCS Interface

#### OCS Application Example

When the occupancy sensor detects people in the meeting room, the transmitter turns on the ceiling lamp.

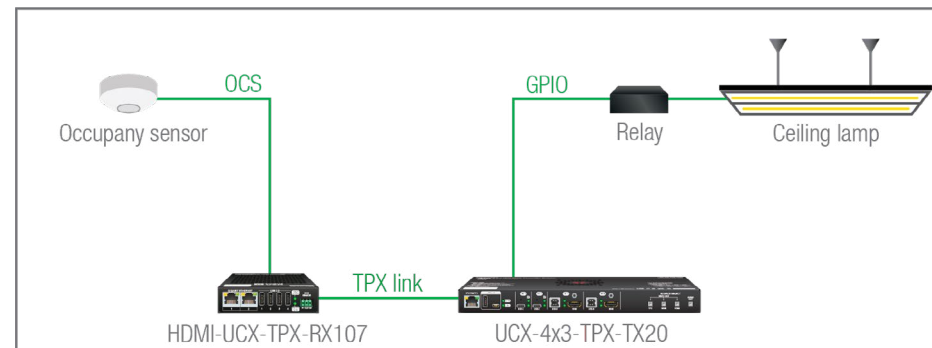

### 5.17. Further Built-in Features

#### 5.17.1. Device Cloning – Configuration Backup and Restore

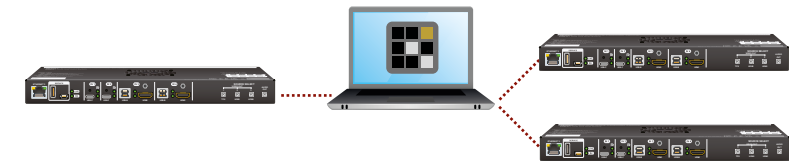

The device (configuration) cloning of UCX-TPX series switcher transmitters is a simple method that eliminates the need to repeatedly configure certain devices to have identical (non-factory) settings. If the devices are installed in the same type of system multiple times, then it is enough to set up only one device to fit the user's needs and then copy those settings to the others, thus saving time and resources.

Cloning is possible between devices using the same firmware version. All LW3 settings and the WelcomeScreen Image will be saved.

Please note that the clone file can be downloaded and uploaded via HTTP or HTTPS, so 80 or 433 port has to be enabled.

See more information about the settings in the [Clone configuration](#) section.

# 6

## Software Control Options

UCX-TPX devices allow setting all the parameters via a user-friendly interface. Open a web browser (Google Chrome or Mozilla Firefox is highly recommended) and connect to the device to access the parameters and settings. The other option is to use the Lightware Device Controller (LDC) software and connect to the device without a web browser. The features are described in the coming sections.

### 6.1. Software Control Modes

The device can be controlled in the following ways:

- Using the **built-in web page**,
- Using the **Lightware Device Controller (LDC)** software,
- Sending **REST API commands** (see the [Lightware REST API Reference](#) chapter), or
- Sending **LW3 commands** (see the [LW3 Programmers' Reference](#) chapter).

#### Built-in web page vs. LDC

The LDC and the built-in web page shows the same content, but there are some minor differences:

Function	Built-in Web	LDC
Platform	A Web browser running under Windows, macOS or Android	Windows, mac OS
Installation	Web browser needed only	Required
Device discovery	-	✓
Logout	✓	-

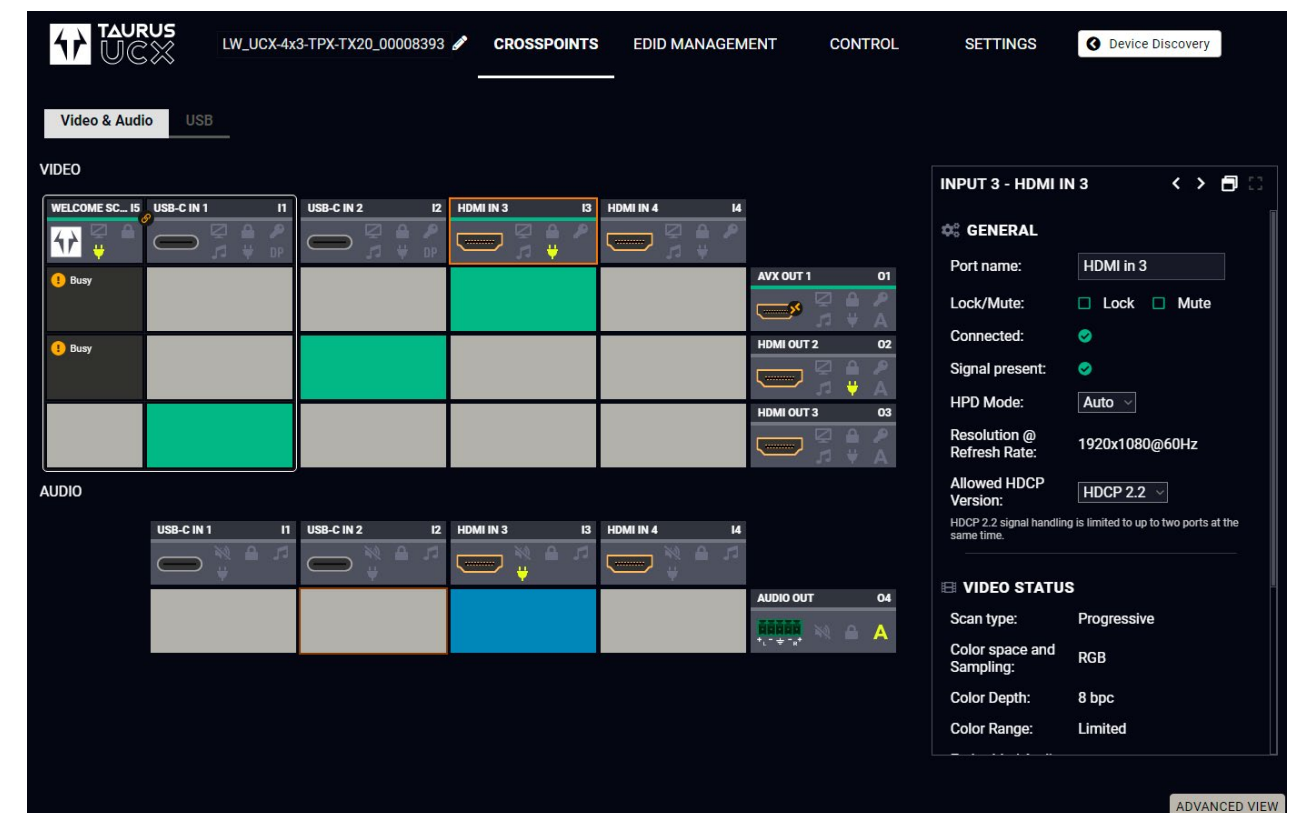

The Main window – displayed in LDC

- ▶ SOFTWARE CONTROL MODES
- ▶ USING THE BUILT-IN WEB
- ▶ INSTALL AND UPDATE THE LDC
- ▶ RUNNING THE LDC
- ▶ ESTABLISHING THE CONNECTION
- ▶ BULK DEVICE MANAGEMENT
- ▶ VIDEO & AUDIO CROSSPOINT
- ▶ PORT PROPERTIES WINDOW
- ▶ CEC TOOL
- ▶ USB CROSSPOINT
- ▶ EDID MENU
- ▶ CONTROL MENU
- ▶ SETTINGS MENU
- ▶ ADVANCED VIEW WINDOW

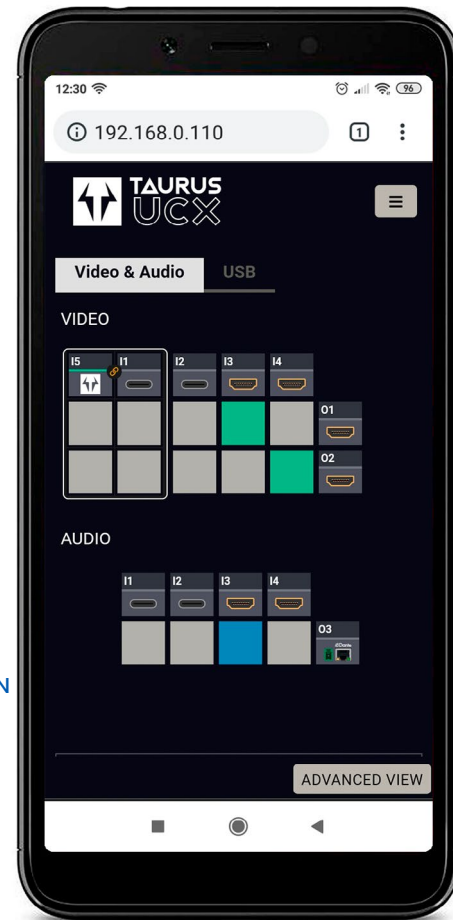

### The Main Window - Displayed on a Smartphone

## 6.2. Using the Built-in Web

UCX-TPX devices can easily be controlled and configured without downloading and installing LDC, by utilizing the built-in web.

Connecting to the device is possible by typing its IP address into the URL of the browser.

The layout of the built-in web is generally the same as the LDC, with a few differences:

- There is no **Device Discovery** button.
- From FW version v1.7.0, there is a **Logout** button.

**INFO:** The **Logout** button will only appear if the device has a password and the user is logged in

**DIFFERENCE:** From FW version v1.7.0, the maximum length of a single session is **120 minutes**. If this time is up, you will be logged out, and the device will only be available upon logging in again.

**DIFFERENCE:** From FW version v1.7.0, in case of **30 minutes** of inactivity the session will expire. The system will remind you in a pop-up window if the current session is about to expire five minutes before the time limit. If the reminder receives no answer, the session will restart and you will be forced to log out.

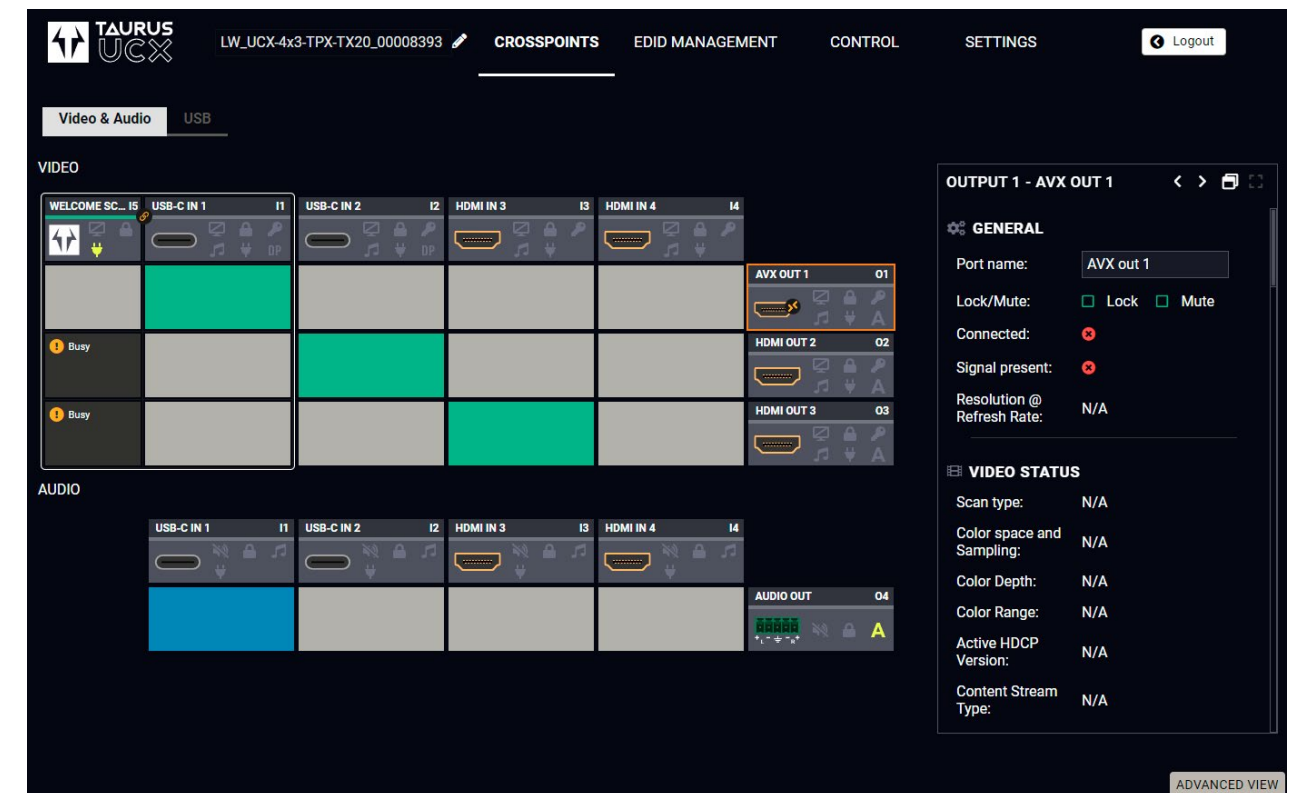

The Logout button appears in the upper right corner upon login

### 6.3. Install and Update the LDC

**INFO:** After the installation, the Windows and the Mac applications have the same look and functionality. This type of the installer is equal with the Normal install in case of Windows and results in an updatable version with the same attributes.

#### Installation for Windows OS

Run the installer. If the User Account Control drops a pop-up message, click **Yes**.

During the installation you will be prompted to select the type of the installation: **normal** and the **snapshot** install:

Normal install	Snapshot install
Available for Windows and macOS	Available for Windows
The installer can update only this instance	Cannot be updated
Only one updatable instance can exist for all users	More than one different version can be installed for all users

#### Comparison of installation types

**ATTENTION!** Using the Normal install as the default choice is highly recommended.

#### Installation for macOS

Mount the DMG file by double clicking on it, and drag the LDC icon over the Applications icon to copy the program into the Applications folder. If you want to copy the LDC into another location, just drag the icon over the desired folder.

#### Updating of LDC

**Step 1.** Run the application.

The **Device Discovery** window appears automatically, and the program checks the available updates on Lightware's website and opens the update window if LDC updates are found.

The current and the update version numbers can be seen at the top of the window and they are shown in this window even with the snapshot install.

The **Update** window can also be opened by clicking the **About icon** and the **Update** button.

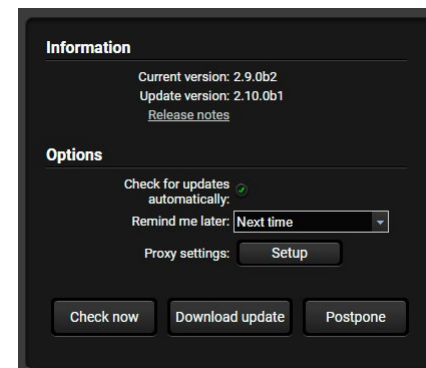

**Step 2.** Set the desired update setting in the **Options** section.

- If you do not want to check for the updates automatically, uncheck the **circle** that contains the green tick.
- If you want to postpone the update, a reminder can be set with different delays from the **drop down list**.
- If the proxy settings traverse the update process, set the proper values, then click on the **OK** button.

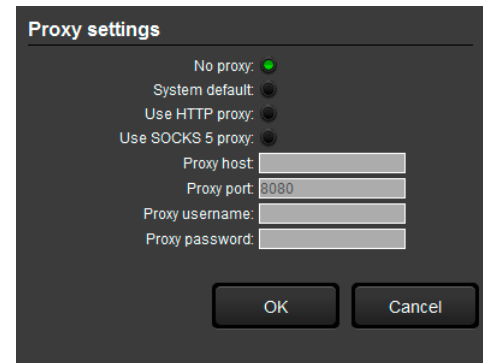

**Step 3.** Click on the **Download update** button to start the updating.

The updates can be checked manually by clicking on the **Check now** button.

## 6.4. Running the LDC

The common way to start the software is to double-click on the LDC icon. But the LDC can be run by command line parameters as follows:

### Connecting to a Device with Static IP Address

The LDC is connected to a device with the indicated static IP address directly; the Device Discovery window is not displayed. When the port number is not set, the default port is used: 6107 (LW3 protocol).

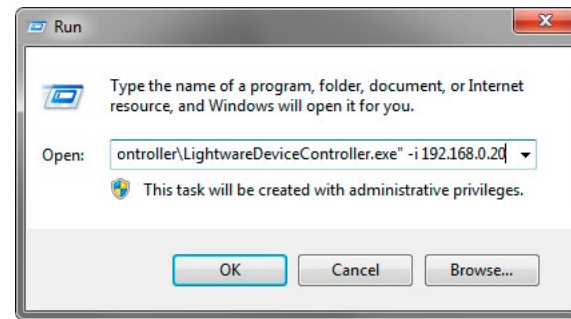

**Format:** LightwareDeviceController -i <IP\_address>:<port>

**Example:** LightwareDeviceController -i 192.168.0.20:6107

### Adjusting the Zoom

The window can be zoomed to a specific value to fit to the resolution of the desktop (higher/lower). '1' is the default value (100%).

**Format:** LightwareDeviceController -z <magnifying\_value>

**Example:** LightwareDeviceController -z 1.2

**ATTENTION!** The last set value is stored and applied when LDC is started without a parameter.

## 6.5. Establishing the Connection

**Step 1.** Connect the device to a computer via Ethernet.

**Step 2.** Run the controller software; device discovery window appears automatically.

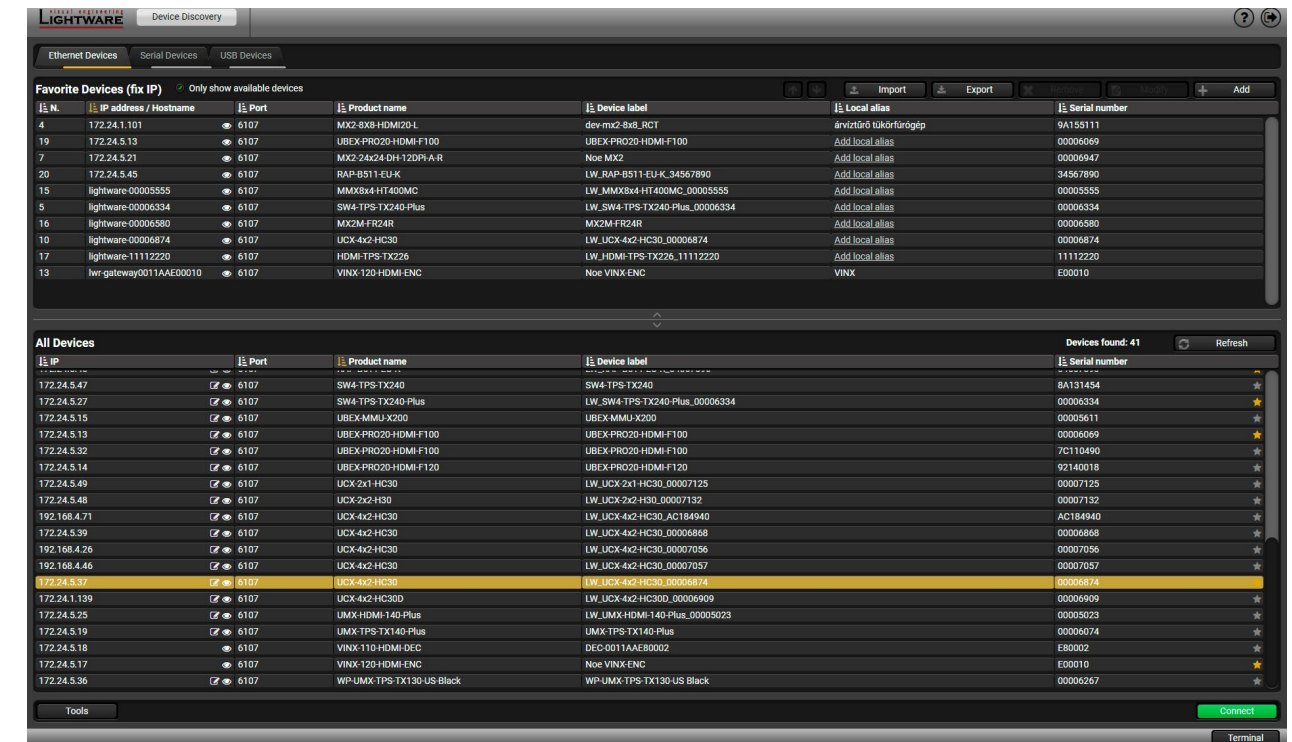

*Device discovery window in LDC*

The Ethernet tab consists of two lists. **All devices** list contains all Lightware devices that are available in the connected network (in the 255.255.0.0 subnet). However, there is no need to browse all the available devices as you can expand the list of **Favorite devices** with any Lightware device that is connected via Ethernet by any of the following ways:

- Mark the desired device with the ★ symbol in the **All Devices** list,
- Press the **Add** button and add the device in the appearing window, or
- **Import** the list of favorite devices that was **exported** previously.

When both the 6107 and 80 ports are disabled, only the secure 443 port remains open, the UCX switcher appears in the all devices list with 443 port.

Double click on the device offers an option to open the other ports (80 and 6107) and use e.g. Lightware Device Controller software.

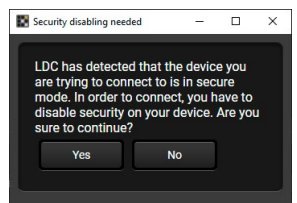



### Add New Favorite Device

**DIFFERENCE:** This feature is available only from 2.5.5 LDC version.

Press the **Add** button; in the appearing window you can enter the **IP address**. The **hostname** of the desired device can be used instead, if it is supported. That allows setting a unique name to identify the device in a network. If the host name is saved in this window and the IP address is changing, the device will still be available and connectible.

**ATTENTION!** The host name connection-feature does not work when the target device is accessed over VPN.

See more information about the host name property in the [Setting the Host name](#) section.

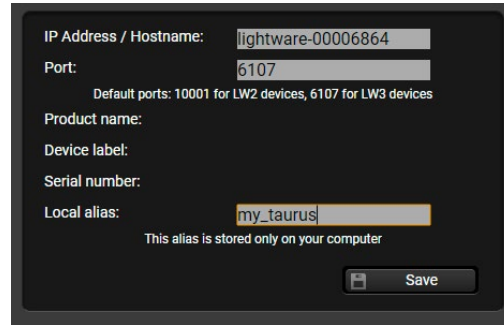

### Import/Export the List of Favorite Devices

**DIFFERENCE:** This feature is available only from 2.5.5 LDC version.

The list of favorite devices can be exported/imported by the dedicated buttons (saved as \*.JSON file). The list can be imported later (in another computer, too), but please note that the current list will be overwritten by the imported list.

### Changing the IP Address



To modify the IP address settings quickly, it is not necessary to enter the device's settings/network menu, you can set them by clicking the pencil icon beside the IP address.

You can see the new settings only in this window. The device needs a few seconds to apply the new settings. *#ipaddress*

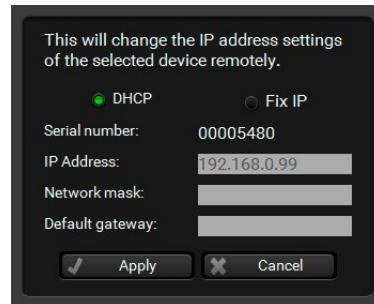

### Identifying the Device



Clicking on the icon results in the blinking of the status LEDs for 10 seconds. The feature helps to find the device itself physically.

## 6.6. Bulk Device Management

It is possible to configure several devices at once with the Bulk Device Management tool. This feature can be accessed by clicking on the Tools button in the bottom left corner of the Device Discovery window and choosing the Bulk Management option.

**DIFFERENCE:** This function is available from the version v2.6.0b6 of the LDC.

### 6.6.1. Network Settings

It is possible to set the network settings of several devices at once by using a .csv file that contains the list of the devices that we need to configure, then uploading it into the LDC.

Please note that if the data in the file is missing or incorrect, then the discovery of the affected device will fail and an 'Invalid data' message will be displayed in the State column. In case of an IP or MAC address conflict, the message is 'Duplicated'.

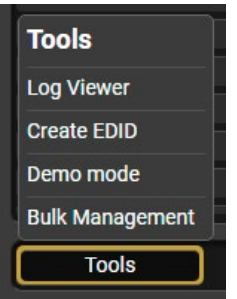

**BULK DEVICE MANAGEMENT**

Network Settings | Device Configuration

CHOOSE NETWORK FILE: template\_new.csv

Discovered	MAC Address	Part Number	DHCP	IP Address	Netmask	Gateway	Host Name	Device Label	State
✓	a8:d2:36:ff:50:23	91560003	DISABLED	192.168.0.111	255.255.255.0	192.168.0.1		LW_UMX-HDMI-140-Plus_00005023	Invalid Data
✓	a8:d2:36:00:55:60	91310042	ENABLED	192.168.0.116	N/A	N/A	MMX8x4	LW_MMX8x4-HT420M_00005560	
✓	a8:d2:36:ff:38:59	91540059	DISABLED	192.168.0.121	255.255.255.0	192.168.0.1	lightware-00003859	UMX-TPS-TX140-kicsirizs	
✓	a8:d2:36:ff:44:29	91310034	ENABLED	192.168.0.121	N/A	N/A	lightware-00004429	MMX4x2-HDMI	Duplicated
✓	a8:d2:36:ff:22:63	91540065	ENABLED	192.168.0.117	N/A	N/A	lightware-00002263	LW_SW4-TPS-TX240-Plus_00002263	
✓	a8:d2:36:ff:99:99	91540021	ENABLED	192.168.0.122	N/A	N/A	lightware-99999999	LW_HDMI-TPS-RX110AY_00005909	
✓	a8:d2:36:f0:69:74	91310082	ENABLED	192.168.0.112	N/A	N/A	lightware-00006974	LW_UCX-4x2-HC30D_00006974	
✓	a8:d2:36:f0:73:16	91310078	ENABLED	192.168.0.115	N/A	N/A	lightware-00007316	LW_MMX2-4x3-H20_00007316	
✓	a8:d2:36:ff:66:02	91310075	ENABLED	192.168.0.127	N/A	N/A	mtg-room1	MMX8x8_USB	

MACADDRESS	PARTNUMBER	DHCP	IP	NETMASK	GATEWAY	HOSTNAME	DEVICELABEL
a8:d2:36:ff:50:23	91560003	DISABLED	192.168.0.111	255.255.255.0	192.168.0.1	lightware-00005023	LW_UMX-HDMI-140-Plus_00005023
a8:d2:36:00:55:60	91310042	ENABLED	192.168.0.116	255.255.255.0	192.168.0.1	MMX8x4	LW_MMX8x4-HT420M_00005560
a8:d2:36:ff:38:59	91540059	DISABLED	192.168.0.121	255.255.255.0	192.168.0.1	lightware-00003859	UMX-TPS-TX140-kicsirizs
a8:d2:36:ff:44:29	91310034	ENABLED	192.168.0.120	255.255.255.0	192.168.0.1	lightware-00004429	MMX4x2-HDMI
a8:d2:36:ff:22:63	91540065	ENABLED	192.168.0.117	255.255.255.0	192.168.0.1	lightware-00002263	LW_SW4-TPS-TX240-Plus_00002263
a8:d2:36:ff:99:99	91540021	ENABLED	192.168.0.122	255.255.255.0	192.168.0.1	lightware-99999999	LW_HDMI-TPS-RX110AY_00005909
a8:d2:36:f0:69:74	91310082	ENABLED	192.168.0.112	255.255.255.0	192.168.0.1	lightware-00006974	LW_UCX-4x2-HC30D_00006974
a8:d2:36:f0:73:16	91310078	ENABLED	192.168.0.115	255.255.255.0	192.168.0.1	lightware-00007316	LW_MMX2-4x3-H20_00007316
a8:d2:36:ff:66:02	91310075	ENABLED	192.168.0.127	255.255.255.0	192.168.0.1	mtg-room1	MMX8x8_USB

Changing the network settings can be done in a few easy steps:

- Step 1.** First alter the settings you need to change in the .csv file that contains the devices. You can use a template file accessible via the **Export template** button and saving the file to your computer, then filling it out with the parameters of the devices. The file contains the MAC address, Partnumber, DHCP status, IP address, Netmask, Gateway, Hostname and Device label of each device.
- Step 2.** Upload the .csv file into the LDC by pressing the **Choose network file** button and browsing the file in the pop-up window. This will result in a list of the devices appearing on the screen.
- Step 3.** Finally, press the **Apply settings** button to execute the changes. This might take up to a minute to finish.

Discovered	MAC Address	Part Number	DHCP	IP Address	Netmask	Gateway	Host Name	Device Label	State
✓	a8:d2:36:ff:50:23	91560003	DISABLED	192.168.0.111	255.255.255.0	192.168.0.1		LW_UMX-HDMI-140-Plus_00005023	Invalid Data
✓	a8:d2:36:00:55:60	91310042	ENABLED	192.168.0.116	N/A	N/A	MMX8x4	LW_MMX8x4-HT420M_00005560	All Done
✓	a8:d2:36:ff:38:59	91540059	DISABLED	192.168.0.121	255.255.255.0	192.168.0.1	lightware-00003859	UMX-TPS-TX140-kicsirizs	Partly Done
✓	a8:d2:36:ff:44:29	91310034	ENABLED	192.168.0.121	N/A	N/A	lightware-00004429	MMX4x2-HDMI	Duplicated
✓	a8:d2:36:ff:22:63	91540065	ENABLED	192.168.0.117	N/A	N/A	lightware-00002263	LW_SW4-TPS-TX240-Plus_00002263	All Done
✓	a8:d2:36:ff:99:99	91540021	ENABLED	192.168.0.122	N/A	N/A	lightware-99999999	LW_HDMI-TPS-RX110AY_00005909	All Done
✓	a8:d2:36:f0:69:74	91310082	ENABLED	192.168.0.112	N/A	N/A	lightware-00006974	LW_UCX-4x2-HC30D_00006974	All Done
✓	a8:d2:36:f0:73:16	91310078	ENABLED	192.168.0.115	N/A	N/A	lightware-00007316	LW_MMX2-4x3-H20_00007316	All Done
✓	a8:d2:36:ff:66:02	91310075	ENABLED	192.168.0.127	N/A	N/A	mtg-room1	MMX8x8_USB	All Done

Message	DHCP enabled	DHCP disabled	Device discovered
✓ All Done	Successful procedure		✓
✗ Partly Done	Failure setting the Host name and/or the Device label		✗
Unavailable device	Host name <b>and</b> Device label missing	IP address, Network, <b>and/or</b> Gateway missing	✗
Failed	Host name <b>and</b> Device label incorrect	IP address, Network <b>and</b> Gateway incorrect	✓
IP mismatch	-	Host name <b>and</b> Device label incorrect	✗

**ATTENTION!** The 'Failed' and 'IP mismatch' status indicators are not common, they appear when the multicast and/or the port used for LMDMP connection is disabled, or if the firmware version of the device is below the recommended (see the pop-up window when opening the Bulk Management or the beginning of this chapter).

### 6.6.2. Device Configuration

**DIFFERENCE:** From v2.6.4 LDC version it is possible to upload configurations to devices protected by a password as well.

Here you can choose the devices that need to be configured and upload a previously saved configuration to all of them at once. This is a helpful tool for quick and easy reconfiguration of the devices after a firmware update. This function allows uploading configurations to devices with the same firmware version, without changing their network settings.

MAC Address	Part Number	DHCP	IP Address	Host Name	Device Label	State
a8:d2:36:ff:50:23	91560003	DISABLED	192.168.0.111	lightware-00005023	LW_UMX-HDMI-140-Plus_0...	Unsupported Device
a8:d2:36:00:55:60	91310042	ENABLED	192.168.0.116	MMX8x4	LW_MMX8x4-HT420M_000...	Unsupported Device
a8:d2:36:ff:38:59	91540059	DISABLED	192.168.0.121	lightware-00003859	UMX-TPS-TX140-kicsirizs	Unsupported Device
a8:d2:36:ff:44:29	91310034	ENABLED	192.168.0.120	lightware-00004429	MMX4x2-HDMI	Unsupported Device
a8:d2:36:ff:22:63	91540065	ENABLED	192.168.0.117	lightware-00002263	LW_SW4-TPS-TX240-Plus_...	Unsupported Device
a8:d2:36:ff:99:99	91540021	ENABLED	192.168.0.122	lightware-99999999	LW_HDMI-TPS-RX110AY_0...	Unsupported Device
a8:d2:36:f0:69:74	91310082	ENABLED	192.168.0.112	lightware-00006974	LW_UCX-4x2-HC30D_0000...	
a8:d2:36:f0:73:16	91310078	ENABLED	192.168.0.115	lightware-00007316	LW_MMX2-4x3-H20_00007...	
a8:d2:36:ff:66:02	91310075	ENABLED	192.168.0.127	mtg-room1	MMX8x8_USB	Unsupported Device
a8:d2:36:f0:69:42	91310082	ENABLED	192.168.0.125	lightware-00006942	LW_UCX-4x2-HC30D_0000...	IP mismatch!
a8:d2:36:f0:33:16	91310078	ENABLED	192.168.0.110	lightware-00003316	LW_MMX2-4x3-H20_00003...	Duplicated
a8:d2:36:f0:71:03	91310078	ENABLED	192.168.0.110	lightware-00007103	LW_MMX2-4x3-H20_00007...	DEVICELABEL mismatch!
a8:d2:36:f0:73:13	91310081	ENABLED	192.168.4.33	lightware-C3257074	LW_UCX-4x2-H30_C325707...	HOSTNAME mismatch! DE...
	91310081	ENABLED	192.168.5.76	lightware-C3258910	LW_UCX-4x2-HC30_C3258...	Invalid Data

Please note that if the data in the .csv file is missing or incorrect, then the discovery of the affected device will fail and an 'Invalid data' message will be displayed in the State column. In case of an IP or MAC address conflict, the message is 'Duplicated', or if the IP address is incorrect, 'IP mismatch!'. 'Hostname mismatch!' or 'Device label mismatch!' appears if the respective values are incorrect.

Changing the configuration of the devices can be done in a few easy steps.

- Step 1.** Set the desired configurations in one of the devices, then clone your configuration in the **Settings** menu, under the **System** tab. Click on the **Download clone file** button in the right, set the file name in the pop-up window and press **Save**. Please note that this file is not available for offline editing.
- Step 2.** Go back to the Device Discovery screen of the LDC, click on the **Tools** button in the bottom left corner and select the **Bulk Management** option.
- Step 3.** Select the Device Configuration tab, then press the black **Device discovery** button for the LDC to list all compatible devices, or upload a device list that has been created beforehand. For such a file, you can use a template by clicking on the **Export template** button and saving it to your computer, see in the previous section. You can upload this file into the LDC by clicking on the **Upload device list** button, browsing the desired file and pressing the **Open** button.

- Step 4.** Once uploaded, you can further select devices from the list to be configured or you can change settings in all of them by ticking the box next to the head of the list.
- Step 5.** To change the configuration of the devices, you need to upload a configuration file previously saved from a device with the same firmware version via the **Upload config file** button. Browse the file in the pop-up window and press **Open**.
- Step 6.** In order to upload a configuration to a device that has authentication, it is necessary to fill out the credentials. This can be done via the **Credential Details** button (key icon in case of a smaller window). LDC will attempt uploading the configuration over HTTPS first, if that fails, it will attempt it over HTTP.
- Step 7.** Click on the **Apply settings** button in the lower right corner to start the reconfiguration procedure.

### BULK DEVICE MANAGEMENT

Network Settings
Device Configuration
EXPORT TEMPLATE

DEVICE DISCOVERY
OR
UPLOAD DEVICE LIST
template\_new.csv
UPLOAD CONFIG FILE
config\_clone\_00007316\_v14...

Only .gz files are supported

<input type="checkbox"/>	MAC Address	Part Number	DHCP	IP Address	Host Name	Device Label	State
<input type="checkbox"/>	a8:d2:36:ff:50:23	91560003	DISABLED	192.168.0.111	lightware-00005023	LW_UMX-HDMI-140-Plus_0...	Unsupported Device
<input type="checkbox"/>	a8:d2:36:00:55:60	91310042	ENABLED	192.168.0.116	MMX8x4	LW_MMX8x4-HT420M_000...	Unsupported Device
<input type="checkbox"/>	a8:d2:36:ff:38:59	91540059	DISABLED	192.168.0.121	lightware-00003859	UMX-TPS-TX140-kicsirizs	Unsupported Device
<input type="checkbox"/>	a8:d2:36:ff:44:29	91310034	ENABLED	192.168.0.120	lightware-00004429	MMX4x2-HDMI	Unsupported Device
<input type="checkbox"/>	a8:d2:36:ff:22:63	91540065	ENABLED	192.168.0.117	lightware-00002263	LW_SW4-TPS-TX240-Plus...	Unsupported Device
<input type="checkbox"/>	a8:d2:36:ff:99:99	91540021	ENABLED	192.168.0.122	lightware-99999999	LW_HDMI-TPS-RX110AY_0...	Unsupported Device
<input type="checkbox"/>	a8:d2:36:f0:69:74	91310082	ENABLED	192.168.0.112	lightware-00006974	LW_UCX-4x2-HC30D_0000...	✘ Firmware version mis...
<input type="checkbox"/>	a8:d2:36:f0:73:16	91310078	ENABLED	192.168.0.115	lightware-00007316	LW_MMX2-4x3-H20_00007...	✔ Configuration saved su...
<input type="checkbox"/>	a8:d2:36:ff:66:02	91310075	ENABLED	192.168.0.127	mtg-room1	MMX8x8_USB	Unsupported Device
<input type="checkbox"/>	a8:d2:36:f0:69:42	91310082	ENABLED	192.168.0.123	lightware-00006942	LW_UCX-4x2-HC30D_0000...	✔ HTTPS: Configuration sa
<input type="checkbox"/>	a8:d2:36:f0:33:16	91310078	ENABLED	192.168.0.110	lightware-00003316	LW_MMX2-4x3-H20_00003...	Duplicated
<input type="checkbox"/>	a8:d2:36:f0:71:03	91310078	ENABLED	192.168.0.110	lightware-00007103	LW_MMX2-4x3-H20_00007...	DEVICELABEL mismatch!
<input type="checkbox"/>	a8:d2:36:f0:73:13	91310081	ENABLED	192.168.4.33	lightware-C3257074	LW_UCX-4x2-H30_C325707...	HOSTNAME mismatch! DE...
<input type="checkbox"/>	91310081	91310081	ENABLED	192.168.5.76	lightware-C3258910	LW_UCX-4x2-HC30_C3258...	Invalid Data

APPLY SETTINGS

The list will be updated when the configuration procedure is finished, where in case of success, the **✔ Configuration saved successfully** message will be displayed in the State column.

Please note that a configuration can only be applied to a device with the same firmware version, otherwise the **✘ Firmware version mismatch** error message will appear under the State column.

If the configuration is applied to a different variant, the **✘ Variant mismatch** error message will appear.

If the network settings are incorrect, applying the configuration will fail, and the message **✘ Incorrect network settings** will appear under the State column.

For more details about saving a configuration, see the [Clone configuration](#) section.

If a device that is in the list is not connected to the network or its IP address is incorrect, the software will fail to detect it, and will display a **✘ Failed to fetch** message in the State column when applying settings.

## 6.7. Video & Audio Crosspoint

#crosspoint #switch

The screenshot displays the TAURUS UCX configuration interface for Video & Audio Crosspoint. The interface is divided into several sections:

- Top Navigation:** Includes tabs for CROSSPOINTS, EDID MANAGEMENT, CONTROL, and SETTINGS. A 'Device Discovery' button is located in the top right corner (10).
- Video Section:** Features a grid of video ports (VIDEO) including USB-C IN 1, 2, HDMI IN 3, and 4. A 'Busy' indicator is shown for USB-C IN 1 (4). A 'Video & Audio' tab is selected (3).
- Audio Section:** Features a grid of audio ports (AUDIO) including USB-C IN 1, 2, and AUDIO OUT 04. A 'Busy' indicator is shown for USB-C IN 1 (5).
- Right Panel (INPUT 1 - USB-C IN 1):** Contains configuration options for the selected port:
  - GENERAL:** Port name (USB-C in 1), Lock/Mute (Lock and Mute checkboxes), Connected status, Signal present status, HPD Mode (Auto), Resolution @ Refresh Rate (N/A), Allowed HDCP Version (HDCP 1.4).
  - VIDEO STATUS:** Scan type (N/A), Color space and Sampling (N/A), Color Depth (N/A), Color Range (N/A), Embedded Audio Present (checked), Active HDCP.
- Bottom Right:** An 'ADVANCED VIEW' button is located (8).

- 1 **Main menu** The available menu items are displayed. The active one is shown underlined in white.
- 2 **Information ribbon** The label shows the device label, which can be edited in the Settings menu - [TX Status](#) tab.
- 3 **Submenu selector** The audio and video crosspoint menu and the USB crosspoint menu are available under the two tabs.
- 4 **Video input ports** Each tile represents a video input port: [Welcome Screen](#), [USB-C Inputs](#), [HDMI Video Inputs](#). The tile below the port shows the current crosspoint setting; if the port is switched to the output, the color of the tile is green, otherwise grey. Clicking on the tile opens the input properties window.
- 5 **Audio input ports** Each tile represents an audio input port. All of them are logical audio ports, they mean the de-embedded audio channel of the selected USB-C/HDMI inputs. For more details, see [Embedded Audio Input](#).
- 6 **Audio output port** Analog audio output port; clicking on the O3 tile opens the [Analog Audio Output](#) window.
- 7 **Video output ports** AVX and HDMI video output ports; clicking on the tile opens the [HDMI Video Output](#) port properties window.
- 8 **Advanced view** Displaying the [Advanced View Window](#), showing the Terminal window and the LW3 protocol tree.
- 9 **Properties window** Settings and status information of the selected panel are displayed in this section. Clicking on the icon  opens the properties section in a new window.
- 10 **Navigation button** The device discovery window can be displayed by clicking on this button.

**ATTENTION!** Video crosspoint has a limitation: I1 and I5 ports are not available at the same time, only one of them can be selected to any output. The **Busy** label on the crosspoint tile refers to the limitation. When I5 is selected for the video source, the de-embedded audio of the I1 is not available because of the video crosspoint limitation. For more details about it, see the port diagram in the [Audio Interface](#) section.

### 6.7.1. Port Tiles



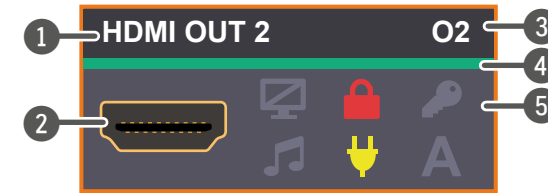











The colors of the port tiles and the displayed icons represent different states and information:



- 1 Port name
- 2 Port symbol
- 3 Port number
- 4 Signal present indicator  
**green:** present  
**grey:** not present
- 5 State indicators

**State Indicators**    *#lock #unlock #mute #unmute*

The following icons display different states of the port/signal:

Icon is grey	Description	Icon is highlighted	Description
	Port is unmuted		Port is muted
	Port is unlocked		Port is locked
	Signal is not encrypted with HDCP		Signal is encrypted with HDCP (the HDCP version is displayed)
	Embedded audio is not present		Embedded audio is present
	There is no connected device		The device is connected
DP	No USB Host connected or DP Alt mode is not supported by USB Host	DP	DP Alternate mode successfully entered
		DP <del>o</del>	Unable to enter DP Alternate mode
A	Autoselect is disabled	A	Autoselect is enabled
	Audio is unmuted		Audio is muted
	Charging function is inactive		Charges the connected device

## 6.8. Port Properties Window

Clicking on the port tile opens the Port properties window. This section shows the available settings and status information by port types. [#lock](#) [#unlock](#) [#mute](#) [#unmute](#)

### 6.8.1. Welcome Screen

Welcome screen is an internal source, which can be customized – see more information in the [Welcome Screen](#) section. [#welcomescreen](#)

**ATTENTION!** Video crosspoint has a limitation: I1 and I5 ports are not available at the same time, only one of them can be selected to any output. The **Busy** label on the crosspoint tile refers to the limitation.

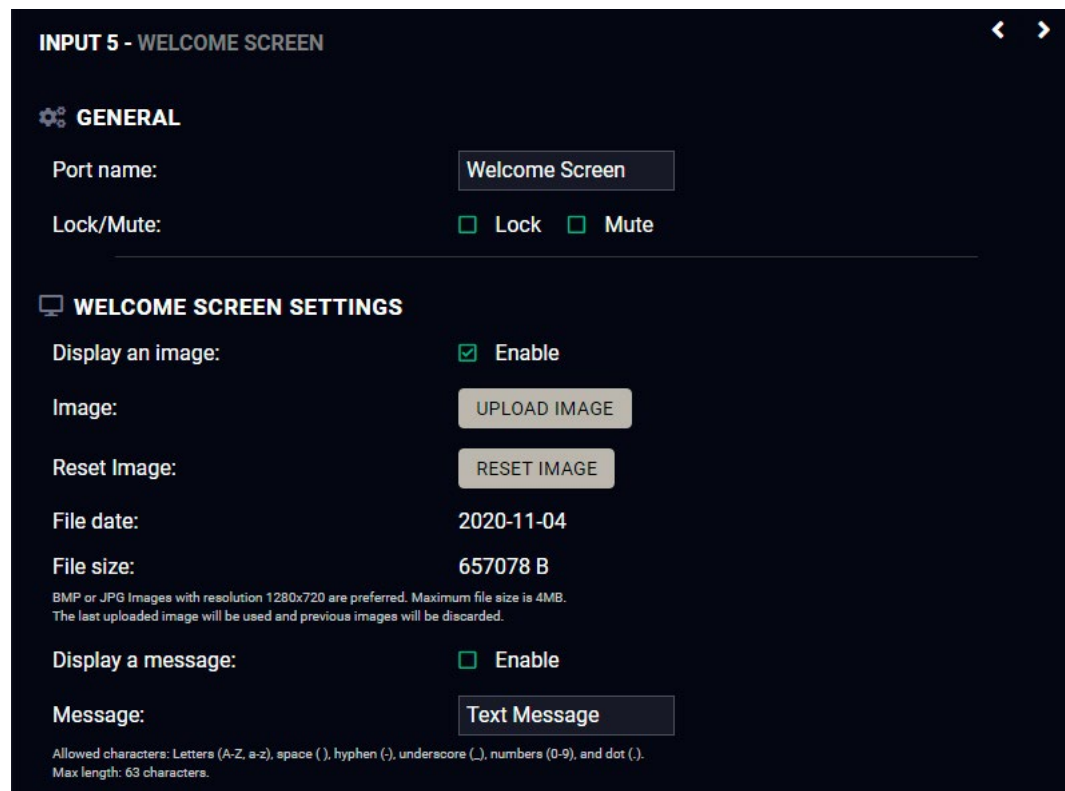

### General

#### Port name

The name of a port can be changed by typing the new name and clicking on the **Set** button. The following characters are allowed when naming: Letters (A-Z) and (a-z), hyphen (-), underscore (\_), numbers (0-9), and dot (.). Max length: 63 characters.

#### Lock [#lock](#) [#unlock](#)

The port can be locked to the currently connected output ports by adding a tick. If the port is locked, the crosspoint state of this port cannot be changed.

#### Mute [#mute](#) [#unmute](#)

The port can be muted/unmuted by adding/removing a tick. If the port is muted, no signal is transmitted from the input port.

### Welcome Screen Settings

#### Display Welcome Screen Image

Add a tick to **Display Welcome Screen Image** to enable the appearance of the internal image.

#### Upload Image

Click on the **Upload Image** button to browse jpg or bmp file to customize the welcome screen picture. Recommended resolution: 1280x720 pixel, maximum file size is 4MB.

**ATTENTION!** Uploading a new image will overwrite the previous one.

#### Reset Image

Clicking on the **reset image** button restores the factory default state.

#### Display Welcome Screen Message

Add a tick to **Display Welcome Screen Message** to enable the appearance of the text message.

#### Welcome Screen Message

The following characters are allowed: Letters (A-Z) and (a-z), hyphen (-), underscore (\_), numbers (0-9), space ( ) and dot (.). Max length: 63 characters.

## 6.8.2. USB-C Inputs

Clicking on the USB-C video input port icon opens the Port properties window. The most important information and settings are available from the panel.

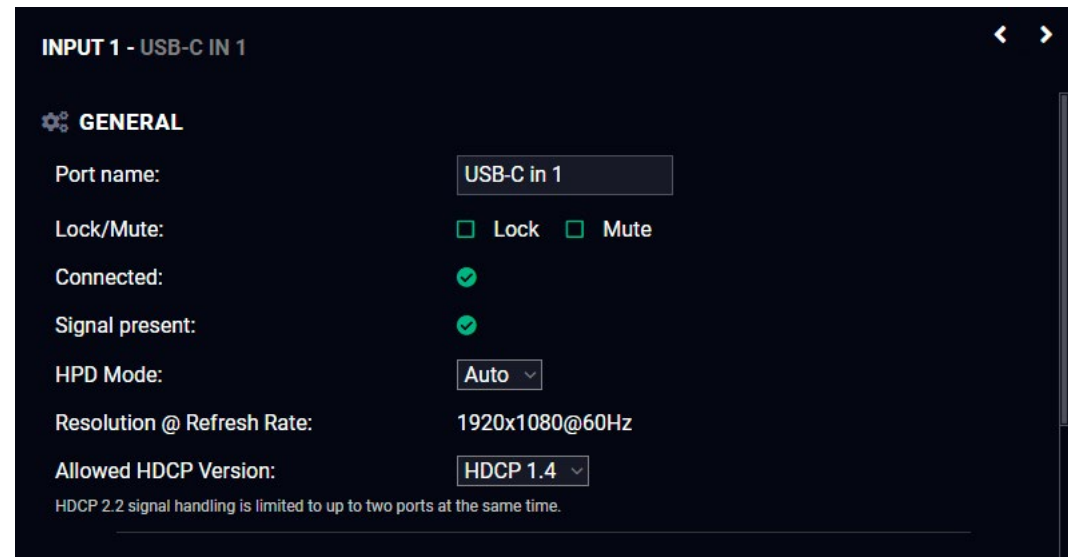

*USB-C input port properties window*

### General

#### Port name

The name of a port can be changed by typing the new name and clicking on the **Set** button. The following characters are allowed when naming: Letters (A-Z) and (a-z), hyphen (-), underscore (\_), numbers (0-9), and dot (.). Max length: 63 characters.

#### Lock *#lock #unlock*

The port can be locked to the currently connected output ports by adding a tick. If the port is locked, the crosspoint state of this port cannot be changed.

#### Mute *#mute #unmute*

The incoming signal can be muted/unmuted by adding a tick. If the port is muted, no signal is transmitted from the input port.

#### HPD Mode

Hot Plug Detection function can be set here. Using Auto mode is highly recommended.

#### Status information

Connected / Signal Presence / Resolution

#### Allowed HDCP Version *#hdcv*

**ATTENTION!** HDCP 2.2 signal handling is limited to up to two input ports at the same time.

- **Off:** The connected source will detect that the switcher is not HDCP-compliant and turn off authentication if the content allows it.
- **HDCP 1.4:** The connected source will detect that the switcher is compliant with HDCP 1.4, but not compliant with HDCP 2.2.
- **HDCP 2.2:** The connected source will detect that the switcher is compliant with HDCP 2.2.

#### Video Status

This section gives a feedback about the current video stream:

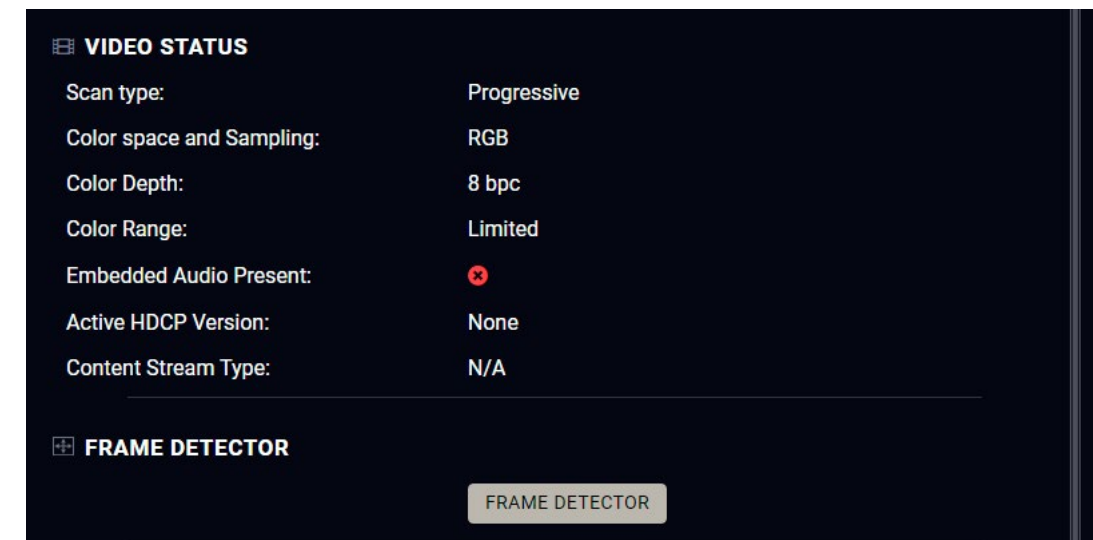

*USB-C input port properties window*

#### Frame detector

For more details, see the [Frame Detector](#) section.

## DisplayPort Link

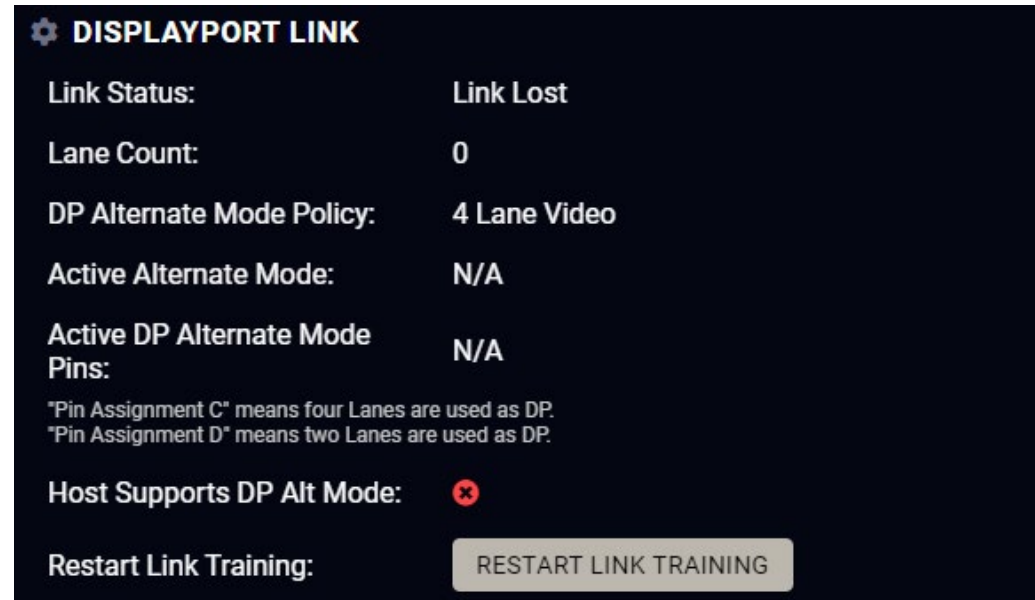
**USB-C input port properties window**

**INFO:** The USB-C source sends Displayport video signal, so the video setting options of the USB-C port are similar to the DisplayPort. The UCX switcher transmitter converts DP signal to HDMI internally.

**DP Alternate Mode Policy**

**DIFFERENCE:** From firmware version v1.8.0 and LDC version v2.8.0, UCX-4x3-TPX-TX20 and UCX-2x1-TPX-TX20 models have **2 Lane Video** setting alongside **4 Lane Video** setting in case the latter is not supported.

**Restart Link Training** *#linktraining*

Link training is a process where the source (PC, laptop, media server) and the sink (switcher transmitter) agree on a data rate, lane count and electrical parameters. The successful link training is a pre-requisite of the video transmission. If the quality of the USB cable is insufficient to reliably handle higher data rates, link training will result in a lower data rate, where stable connection between the source and the switcher can be maintained.

Clicking on the **Restart Link Training** button starts to build up the connection again between the switcher and the source (it happens automatically when the source is connected). It is equal to unplugging and reconnecting the Type-C connector.

**6.8.3. HDMI Video Input**

Clicking on the HDMI video input port icon results in opening the Port properties window. The most important information and settings are available from the panel.

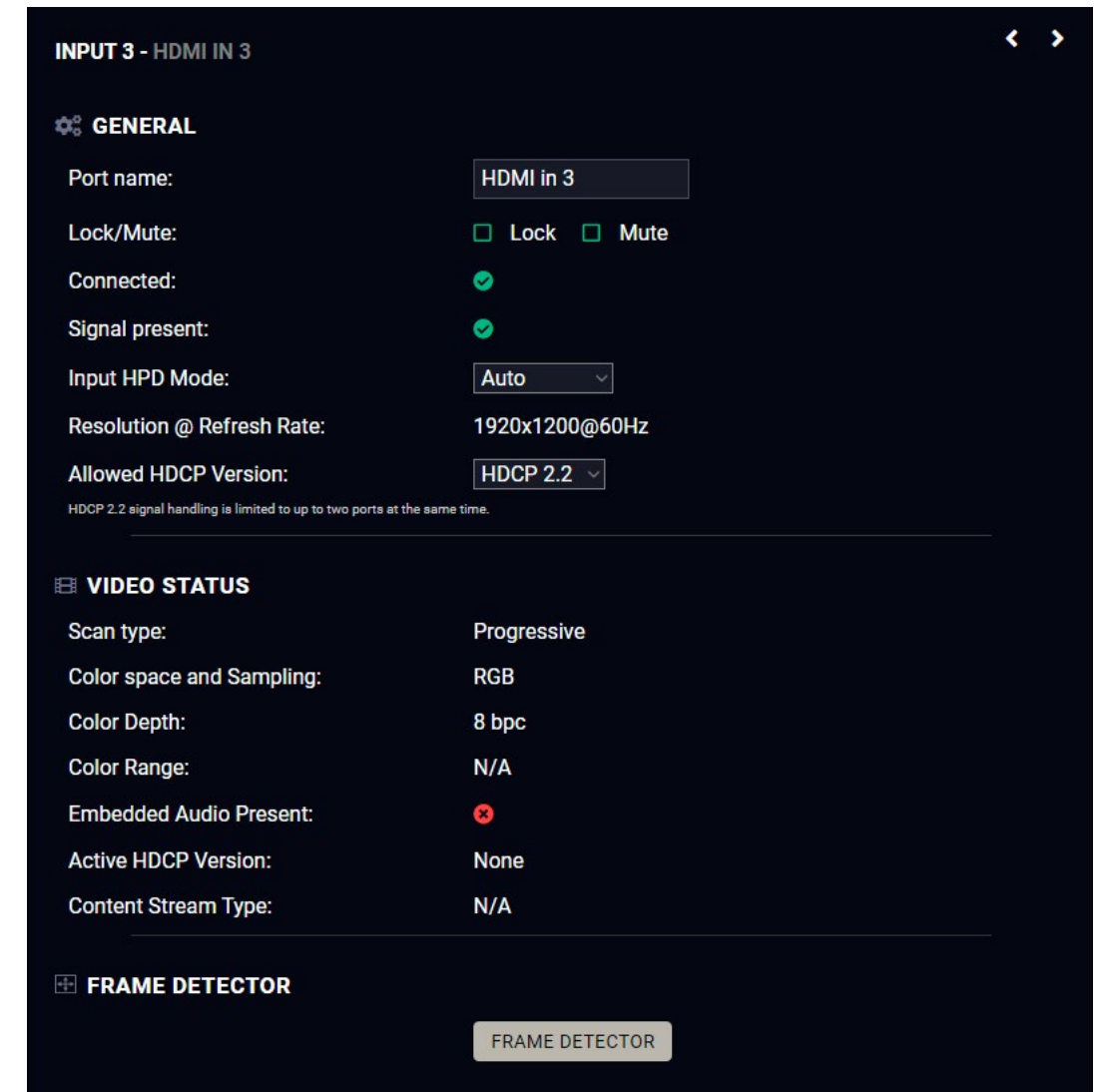
**Port properties window of the HDMI video input**

### Available settings and tools

#### Port name

The name of a port can be changed by typing the new name and clicking on the **Set** button. The following characters are allowed when naming: Letters (A-Z) and (a-z), hyphen (-), underscore (\_), numbers (0-9), and dot (.). Max length: 63 characters.

#### Lock *#lock #unlock*

The port can be locked to the currently connected output ports by adding a tick. If the port is locked, the crosspoint state of this port cannot be changed.

**INFO:** When the locked input is switched to the output, the crosspoint state can not be changed and all inputs are locked in that line.

#### Mute *#mute #unmute*

The incoming signal can be muted/unmuted by adding/removing a tick. If the port is muted, no signal is transmitted from the input port.

#### Allow HDCP Version *#hdcv*

**ATTENTION!** HDCP 2.2 signal handling is limited to up to two input ports at the same time.

- **Off:** The connected source will detect that the switcher transmitter is not HDCP-compliant and turn off authentication if the content allows it.
- **HDCP 1.4:** The connected source will detect that the switcher transmitter is compliant with HDCP 1.4, but not compliant with HDCP 2.2.
- **HDCP 2.2:** The connected source will detect that the switcher transmitter is compliant with HDCP 2.2.

#### Frame detector

For more details, see the [Frame Detector](#) section.

### 6.8.4. HDMI Video Output

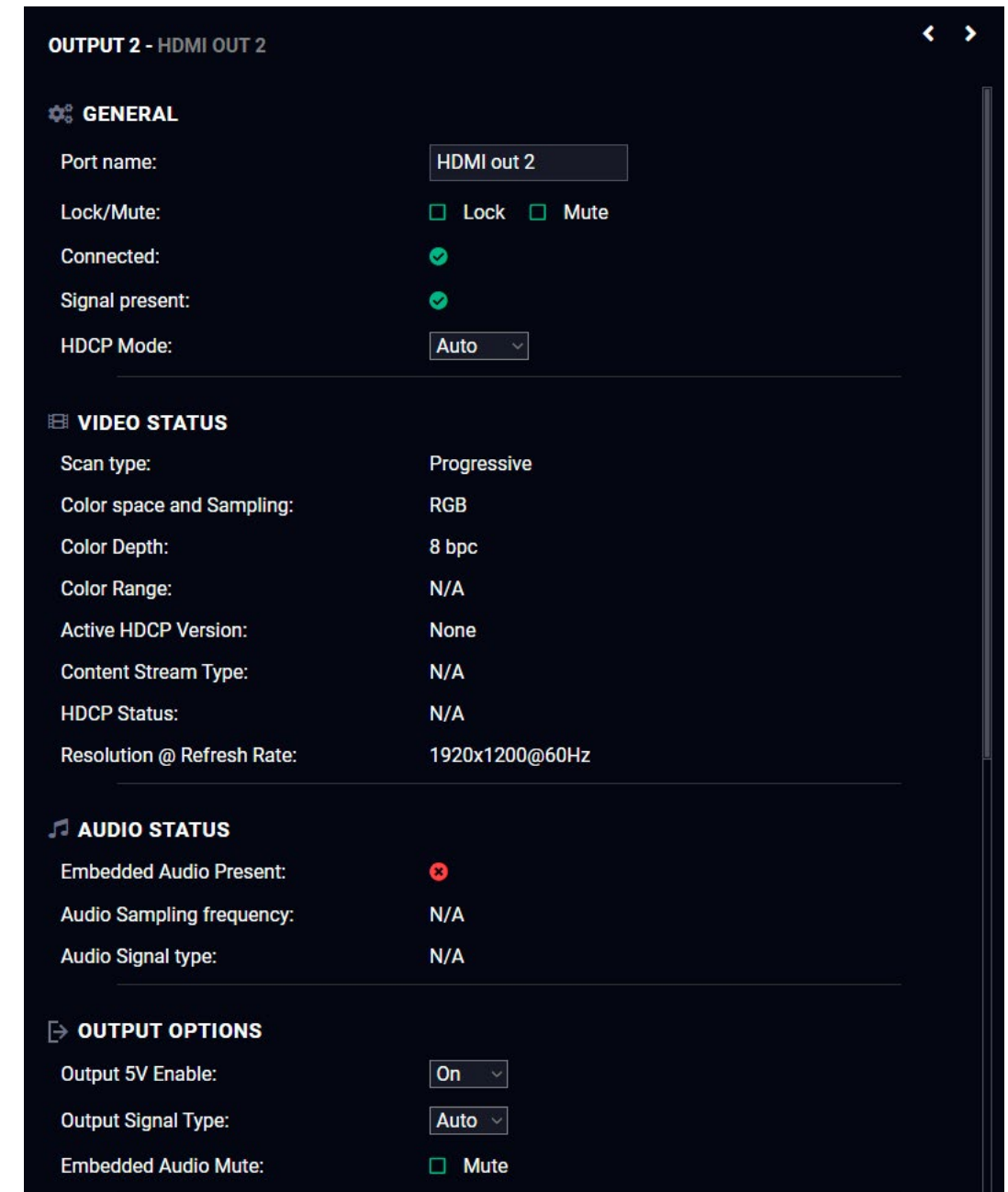

*Port properties window of the HDMI video output*



## Available settings and tools

### General

#### Port name

The name of a port can be changed by typing the new name and clicking on the **Set** button. The following characters are allowed when naming: Letters (A-Z) and (a-z), hyphen (-), underscore (\_), numbers (0-9), and dot (.). Max length: 63 characters.

#### Lock *#lock #unlock*

The port can be locked to the currently connected output ports by adding a tick. If the port is locked, the crosspoint state of this port cannot be changed.

#### Mute *#mute #unmute*

The incoming signal can be muted/unmuted by adding/removing a tick. If the port is muted, no signal is transmitted from the input port.

#### HDCP Mode *#hdc*

- **HDCP mode:** Auto / Always - The transmitter forces the source to send the signal without encryption if the content allows when Auto mode is selected; *#signaltype #hdc*

### Output Options

#### Output 5V Enable

- Auto / On / Off - The setting lets the source and the sink devices be connected – independently of the transmitted signal.

#### Output Signal Type

- Auto / DVI - The outgoing signal format can be selected from a drop-down menu.

#### Embedded Audio Mute

Add a tick to turn off the embedded audio.

### Frame detector

For more details, see the [Frame Detector](#) section.

### Autoselect

Autoselect feature makes the switching of an input to an output without human intervention possible. The crosspoint state changes based on the active input signals.

Three operation policies can be set: *#autoselect #videoautoselect*

**Disable autoselect:** crosspoint state change happens manually.

**First detect:** selected input port is kept connected to the output as long as it has an active signal.

**Last detect mode:** it is always the last attached input that is selected to be transmitted.

**Individual input settings:** it is always the highest priority active input that is selected to be transmitted (1-highest priority, 100-lowest priority).

Pay attention to the following settings for the proper operation of the Autoselect function:

- Be sure that all priority values are filled in;
- Be sure that all inputs are enabled with the green tick on the right side;
- Always click on the **Apply autoselect settings** button after the changes to launch the new settings.

See more details about the feature in the [The Autoselect Feature](#) section.

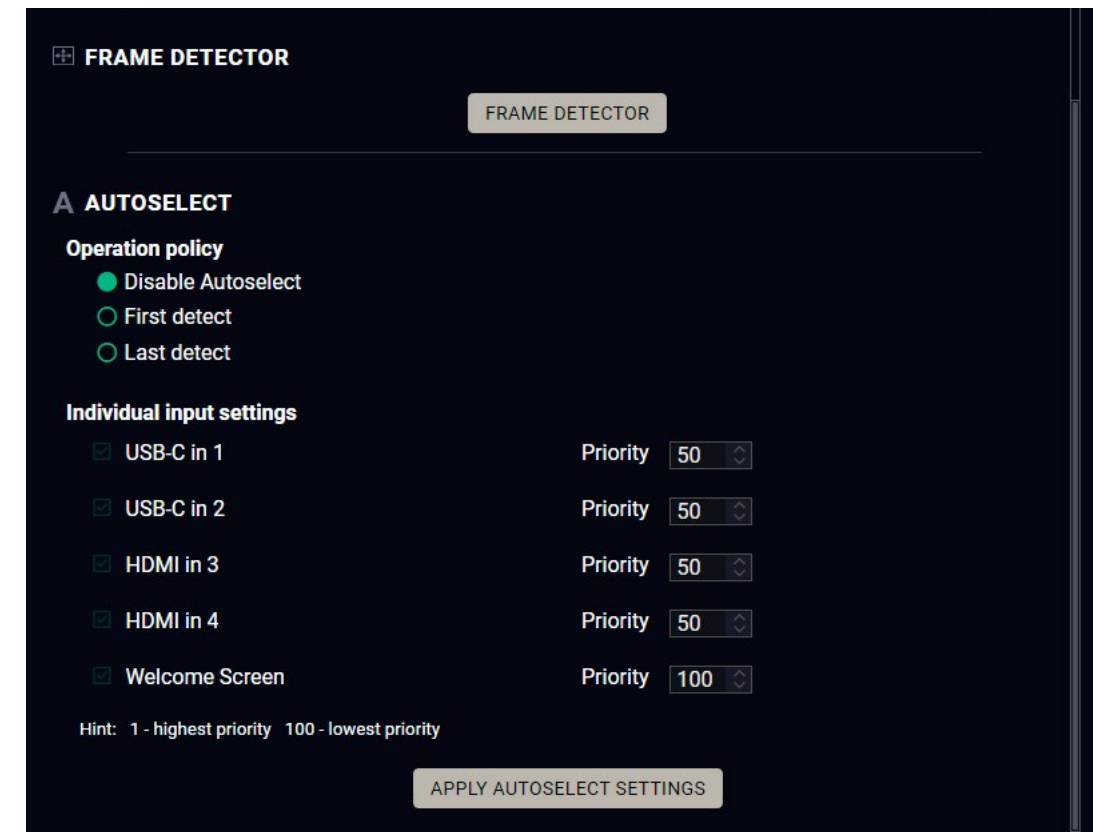

### 6.8.5. Embedded Audio Input



*Port properties window of the audio input*

#### Available settings

##### Port name

The name of a port can be changed by typing the new name and clicking on the **Set** button. The following characters are allowed when naming: Letters (A-Z) and (a-z), hyphen (-), underscore (\_), numbers (0-9), and dot (.). Max length: 63 characters.

##### Lock *#lock #unlock*

The port can be locked to the currently connected output ports by adding a tick. If the port is locked, the crosspoint state of this port cannot be changed.

##### Mute *#mute #unmute*

The incoming signal can be muted/unmuted by adding/removing a tick. If the port is muted, no audio signal is transmitted from the input port.

**ATTENTION!** Video crosspoint has a limitation: I1 and I5 ports are not available at the same time, only one of them can be selected to any output. When I5 is selected for video source, the de-embedded audio of the I1 is not available because of the video crosspoint limitation. For more details about it, see the port diagram in the [Audio Interface](#) section.

### 6.8.6. Analog Audio Output

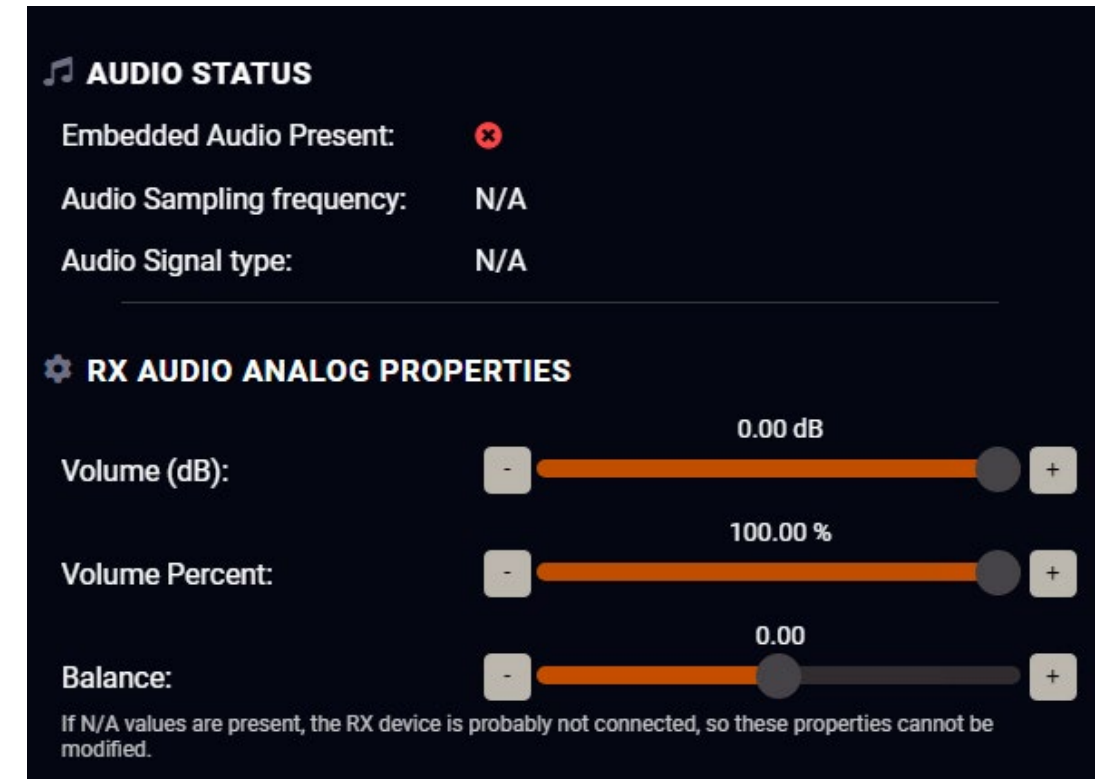

*Port properties window of the RX analog audio output*

#### Available settings: *#analogaudio #volume #balance*

- Port name
- Mute/unmute the port;
- Lock/unlock the port;
- Autoselect settings: off / follow video (O1 or O2). Follow video option means that the audio of the selected video input will be switched to the analog audio output. When the video crosspoint changes, audio crosspoint follows it.
- Volume: from 100 to 0%, in step 1% (0 dB to -95.625 dB, in step 0.375 dB (default is 0 dB));
- Balance: from -100 to +100, in step 1 (default is 0 = center).

### 6.8.7. Frame Detector

The ports can show detailed information about the signal like full size and active video resolution. This feature is a good troubleshooter if compatibility problems occur during system installation. To access this function, open the port properties window and click on the **Frame detector** button. `#framedetector`

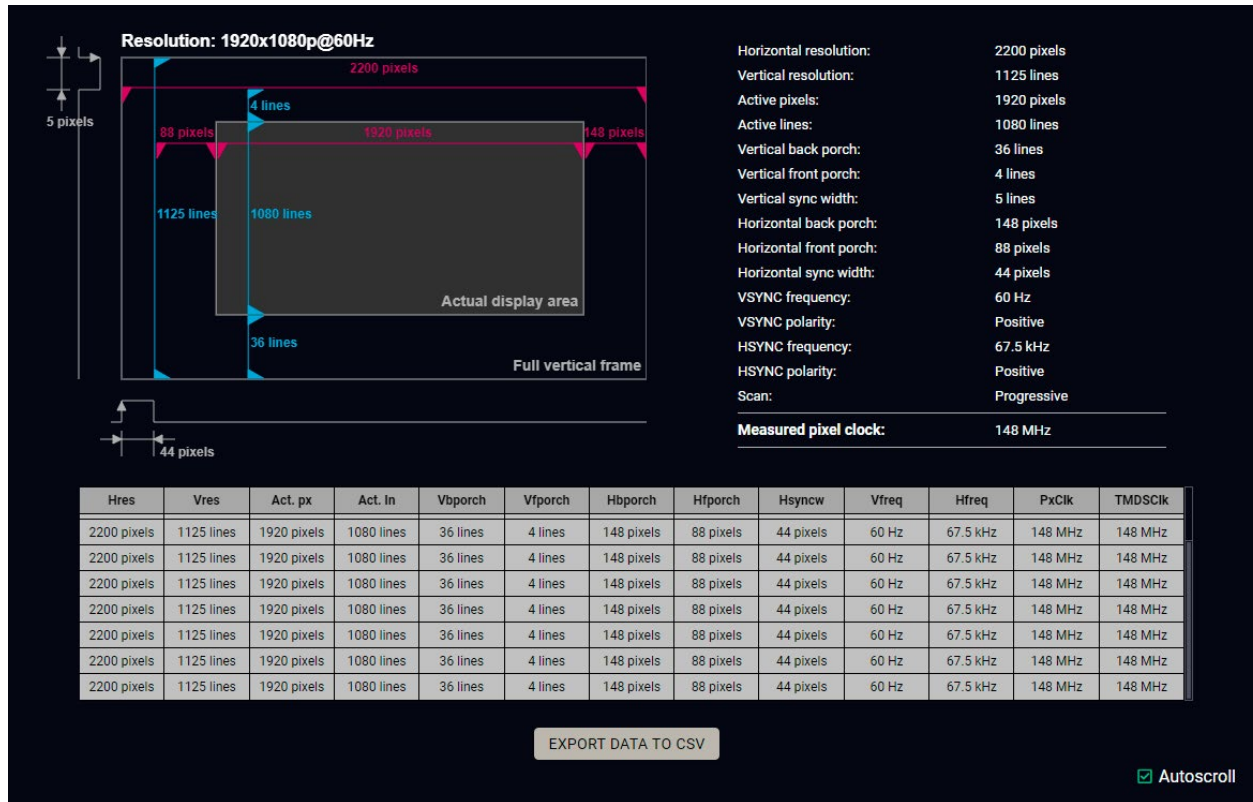

Frame Detector Window

Lightware's Frame Detector function works like a signal analyzer and makes it possible to determine the exact video format that is present on the port, thus helps identify many problems. E.g. actual timing parameters may differ from the expected and this may cause some displays to drop the picture.

Frame Detector measures detailed timings on the video signals just like a built-in oscilloscope, but it is much easier to use. The actual display area shows the active video size (light grey). Dark grey area of the full frame is the blanking interval, which can contain the info frames and embedded audio data for HDMI signals. Shown values are measured directly on the signal and not retrieved only from the HDMI info frames.

It is possible to download the results by clicking on the **Export Data to CSV** button.

Automatic scrolling can be toggled by clicking on the **Autoscroll** checkbox in the lower right corner. It is enabled by default.

### 6.9. CEC Tool

The device is able to send Consumer Electronics Control (CEC) commands via the HDMI outputs. This feature is to remote control the sink device. CEC is a bi-directional communication via the HDMI cable.

`#cec`

**ATTENTION!** Make sure that the controlled unit is CEC-capable and this function is enabled.

**INFO:** UCX-TPX series devices are only capable of sending CEC commands, but not of receiving them.

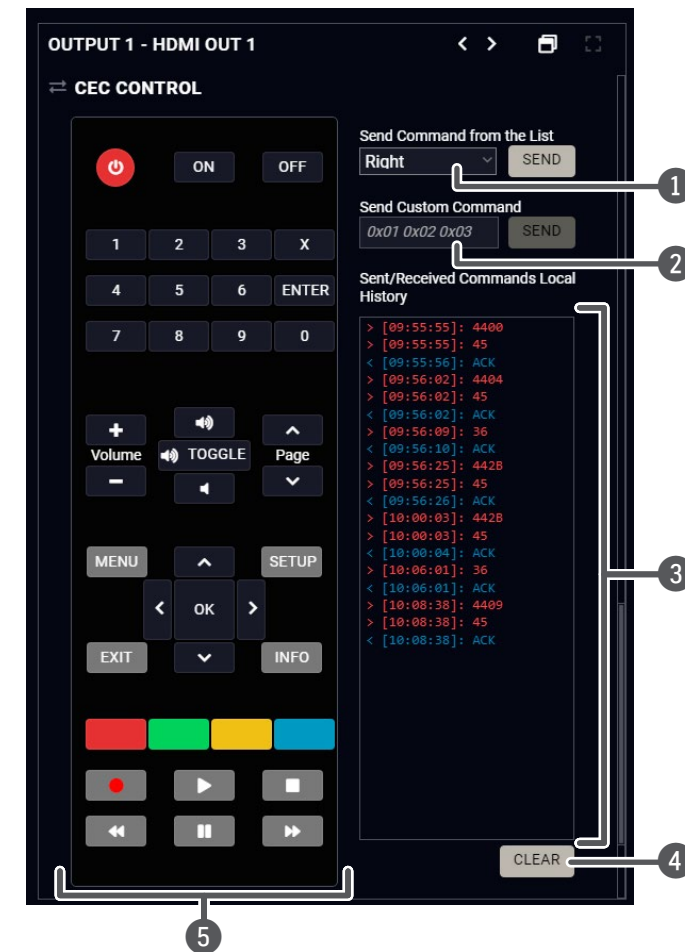

- 1 **Drop-down command list** Containing the basic CEC commands, most of them are displayed on the graphical interface too (on the left side). Click on the **Send** button to send the command.
- 2 **Custom command textbox** The text field is for sending hexadecimal commands in the indicated format to the source. Click on the **Send** button to send the command.
- 3 **Received Command box** Displays all the sent CEC commands (in red) and the received answers (in blue) with a timestamp.
- 4 **Clear button** Click on the **Clear** button to erase the content of the terminal window.
- 5 **CEC command button panel** This panel provides the quick and easy management of CEC commands. These buttons are pre-programmed with basic functions and send commands towards the sink. The communication is displayed in the Received Command box. For the list of the commands, see the [CEC Command Sending](#) section. Both the layout and functionality are similar to the design of a remote control.

It can occur that the third-party device can receive, but not execute the command, because it is not supported by the product. Check the accepted commands in the documentation of the device.

## 6.10. USB Crosspoint

In USB crosspoint tab, the connection between the of the upstream ports (USB-C and USB-B ports) and the USB hub (USB-A ports) can be set. `#usb #usbc`

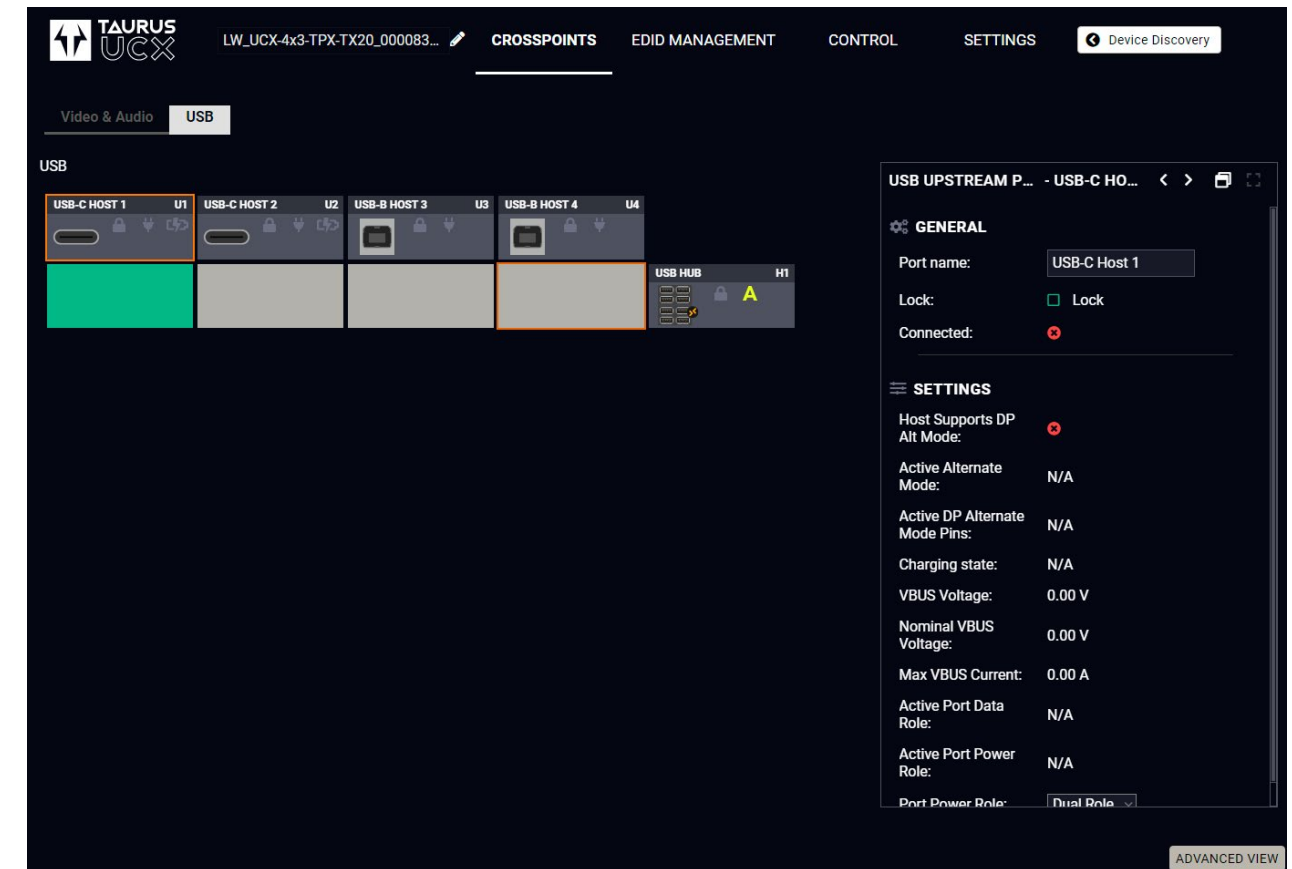

### 6.10.1. USB-C Port Properties

**USB UPSTREAM PORT 1 - USB-C HOST 1** < >

**GENERAL**

Port name:

Lock:  Lock

Connected:

USB-C Power Limit:

---

**SETTINGS**

Host Supports DP Alt Mode: ✘

Active Alternate Mode: DP

Active DP Alternate Mode Pins: Pin Assignment C

\*Pin Assignment C\* means four Lanes are used as DP and USB 2.0 is supported.  
\*Pin Assignment D\* means two Lanes are used as DP and USB 3.1 is supported.

DP Alternate Mode Policy:

Charging state: Charging

VBUS Voltage: 5.00 V

Nominal VBUS Voltage: 5.00 V

Max VBUS Current: 3.00 A

Active Port Data Role: UFP

Active Port Power Role: Source

Port Power Role:

#### Available settings and tools

##### General

###### Port name

The name of a port can be changed by typing the new name and clicking on the **Set** button. The following characters are allowed when naming: Letters (A-Z) and (a-z), hyphen (-), underscore (\_), numbers (0-9), and dot (.). Max length: 63 characters.

###### Lock *#lock #unlock*

The port can be locked to the currently connected output ports by adding a tick. If the port is locked, and the crosspoint state of this port cannot be changed.

##### USB-C Power Limit

**ATTENTION!** Only the UCX-4x3-TPX-TX20 is capable of charging two devices with 60W at once - UCX-2x1-TPX-TX20 has only one USB-C port, thus it can only charge one device up to 100W.

Choose a powering option from the drop-down menu: *#power*

- **Equal output power:** both USB-C ports supplies max. 60W power.
- **Port 1 maximum, Port 2 minimum:** U1port supplies max. 100W power, U2 port supplies 5V/3A.
- **Port 2 maximum, Port 1 minimum:** U2port supplies max. 100W power, U1 port supplies 5V/3A.

##### Settings

###### DP Alternate Mode Policy

This is equal to the [DP Alternate Mode Policy](#) setting on the USB-C video port. *#dpaltmode #alternatemode #displayportalternatemode*

###### Power Role

**Dual role:** The switcher transmitter can be source (and sends power to the connected device) or sink (the switcher transmitter does not send power, real power consumption does not happen) depending on the connected device.

**INFO:** Using **Dual role** setting is highly recommended, the other options are mainly for troubleshooting.

**Source:** When the connected device is a sink (e.g. smart phone or a dual-role laptop), the switcher transmitter charges it via the USB-port.

**Sink:** When the power role of the connected device is source-only (e.g. PC), the switcher has to change its power role (sink or dual-role) to build up the connection. Real power consumption does not happen.

### 6.10.2. USB-B Port Properties



**USB UPSTREAM PORT 3 - USB-B HOST 3**

**GENERAL**

Port name:

Lock:  Lock

Connected: ✘

#### Available settings and tools [#usb](#) [#usbc](#)

##### Port name

The name of a port can be changed by typing the new name and clicking on the **Set** button. The following characters are allowed when naming: Letters (A-Z) and (a-z), hyphen (-), underscore (\_), numbers (0-9), and dot (.). Max length: 63 characters.

##### Lock [#lock](#) [#unlock](#)

The port can be locked to the currently connected output ports by adding a tick. If the port is locked, the crosspoint state of this port cannot be changed.

### USB Hub Properties

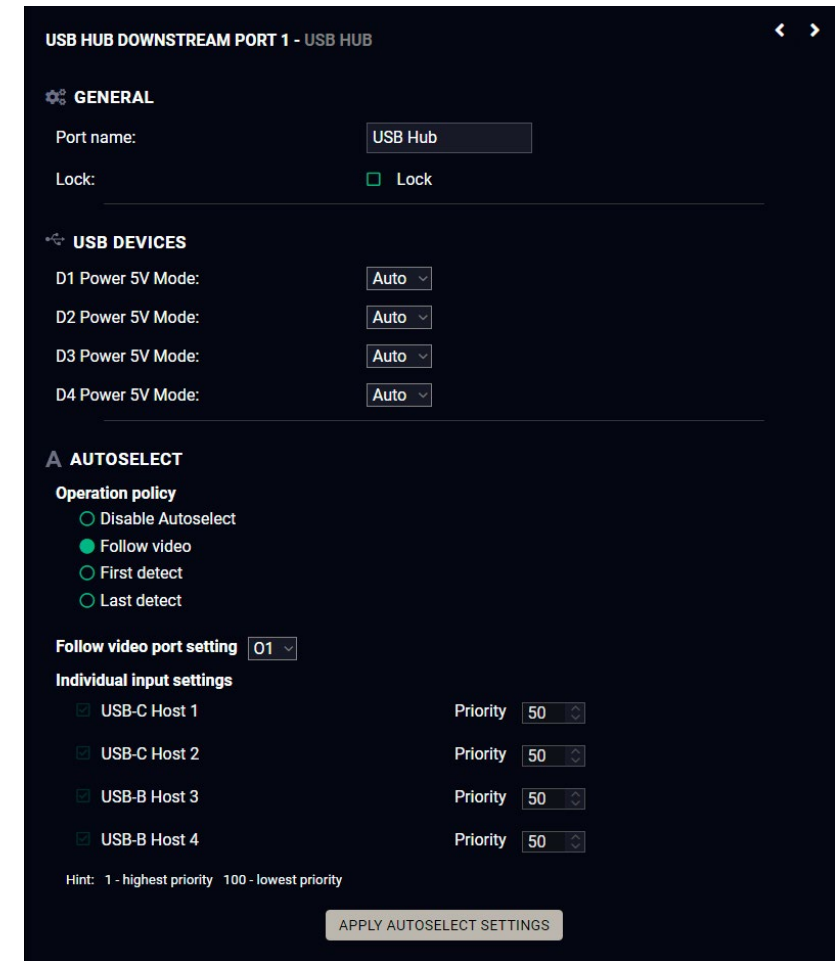

**USB HUB DOWNSTREAM PORT 1 - USB HUB**

**GENERAL**

Port name:

Lock:  Lock

**USB DEVICES**

D1 Power 5V Mode:

D2 Power 5V Mode:

D3 Power 5V Mode:

D4 Power 5V Mode:

**AUTOSELECT**

**Operation policy**

Disable Autoselect

Follow video

First detect

Last detect

Follow video port setting:

**Individual input settings**

Input	Priority
<input checked="" type="checkbox"/> USB-C Host 1	<input type="text" value="50"/>
<input checked="" type="checkbox"/> USB-C Host 2	<input type="text" value="50"/>
<input checked="" type="checkbox"/> USB-B Host 3	<input type="text" value="50"/>
<input checked="" type="checkbox"/> USB-B Host 4	<input type="text" value="50"/>

Hint: 1 - highest priority 100 - lowest priority

#### Available settings and tools

##### General

##### Port name

The name of a port can be changed by typing the new name and clicking on the **Set** button. The following characters are allowed when naming: Letters (A-Z) and (a-z), hyphen (-), underscore (\_), numbers (0-9), and dot (.). Max length: 63 characters.

##### Lock [#lock](#) [#unlock](#)

The port can be locked to the currently connected output ports by adding a tick. If the port is locked, the crosspoint state of this port cannot be changed.

**Autoselect** #autoselect #usbautoselect

For more details about this feature, see the [Autoselect](#) section.

**Autoselect settings:** Disable autoselect / Follow video / First detect / Last detect mode / Individual input settings

Follow video (O1 or O2): Follow O2 means the same computer will be the video source for O2 output and the USB Host of all USB downstream devices.

Video and USB ports either have a common USB Type-C connector for each port, or an HDMI and USB-B are clearly marked to belong together as one port.

**USB Devices**

The power 5V Mode can be set for each port from the drop-down menu: When the option is **Off**, the switcher does not send the device 5V over the USB-A port. Using **Auto** mode is recommended.

**6.11. EDID Menu**

Advanced EDID Management can be accessed by selecting the EDID menu. There are two panels: the left one contains Source EDIDs, the right one contains Destination places where the EDIDs can be emulated or copied to.

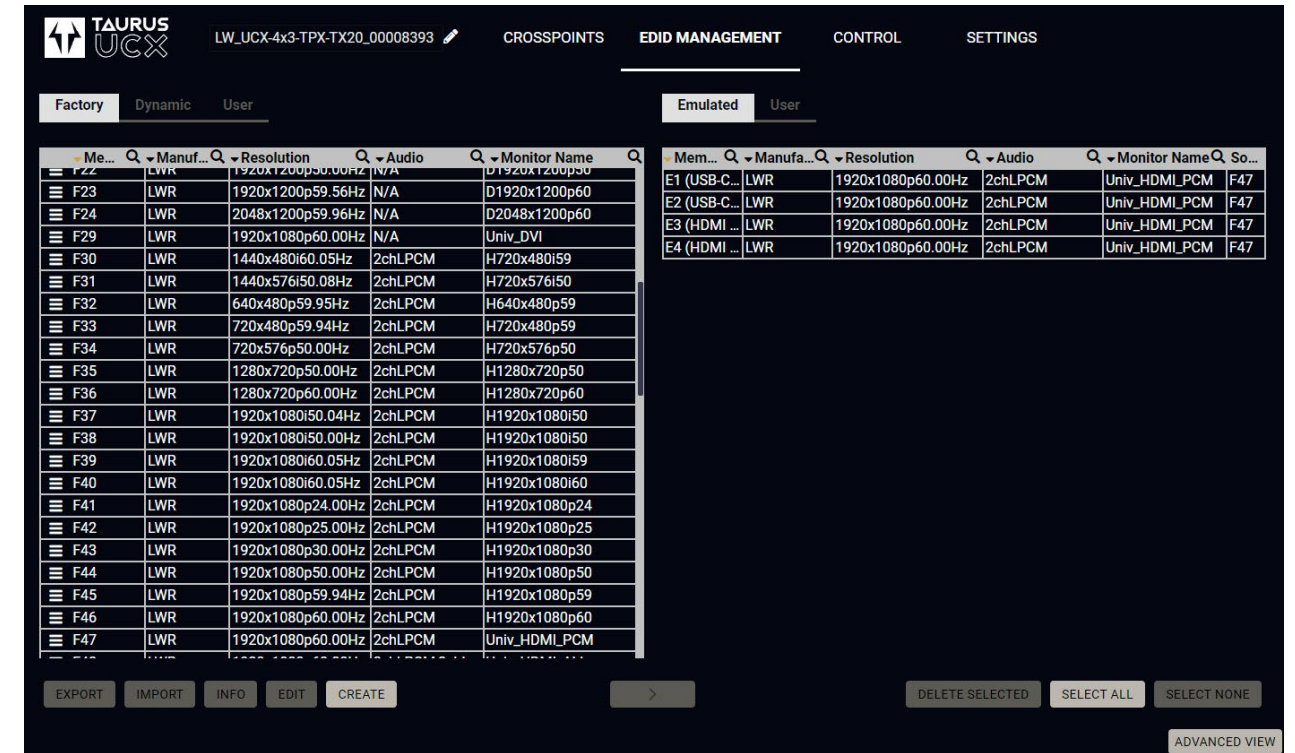

**EDID Menu**

**Control Buttons**

- EXPORT
Exporting an EDID (save to a file)
- IMPORT
Importing an EDID (load from a file)
- INFO
Display EDID Summary window
- EDIT
Opening Advanced EDID Editor with the selected EDID
- CREATE
Opening Easy EDID Creator
- >
Transfer button: executing EDID emulation or copying
- DELETE SELECTED
Deleting EDID (from User memory)
- SELECT ALL
Selecting all memory places in the right panel
- SELECT NONE
Selecting none of the memory places in the right panel

#edid

### 6.11.1. EDID Operations

#### Changing Emulated EDID

- Step 1.** Choose the desired **EDID list** on the source panel and select an **EDID**. 
- Step 2.** Press the **Emulated** button on the top of the Destination panel.
- Step 3.** Select the desired **port** on the right panel (one or more ports can be selected); the EDID(s) will be highlighted in yellow.
- Step 4.** Press the **Transfer** button to change the emulated EDID.

#### Learning an EDID

The process is the same as changing the emulated EDID; the only difference is the Destination panel: press the **User** button. Thus, one or more EDIDs can be copied into the user memory either from the factory memory or from a connected sink (Dynamic).

#### Exporting an EDID

A source EDID can be downloaded as a file (\*.bin, \*.dat or \*.edid) to the computer.

- Step 1.** Select the desired **EDID** from the Source panel (line will be highlighted in yellow).
- Step 2.** Press the **Export** button to open the dialog box and save the file to the computer.

#### Importing an EDID

A previously saved EDID (\*.bin, \*.dat or \*.edid file) can be uploaded to the user memory: 

- Step 1.** Press the **User** button on the top of the Source panel and select a **memory** slot.
- Step 2.** Press the **Import** button below the Source panel.
- Step 3.** Browse the file in the opening window then press the **Open** button. The browsed EDID is imported into the selected User memory.

**ATTENTION!** The imported EDID overwrites the selected memory place even if it is not empty.

#### Deleting EDID(s)

The EDID(s) from User memory can be deleted as follows: 

- Step 1.** Press the **User** button on the top of the Destination panel.
- Step 2.** Select the desired **memory** slot(s); one or more can be selected (“Select All” and “Select None” buttons can be used). The EDID(s) will be highlighted in yellow.
- Step 3.** Press the **Delete selected** button to delete the EDID(s).

### 6.11.2. EDID Summary Window

Select an EDID from the Source panel and press the **Info** button to display the EDID summary. 

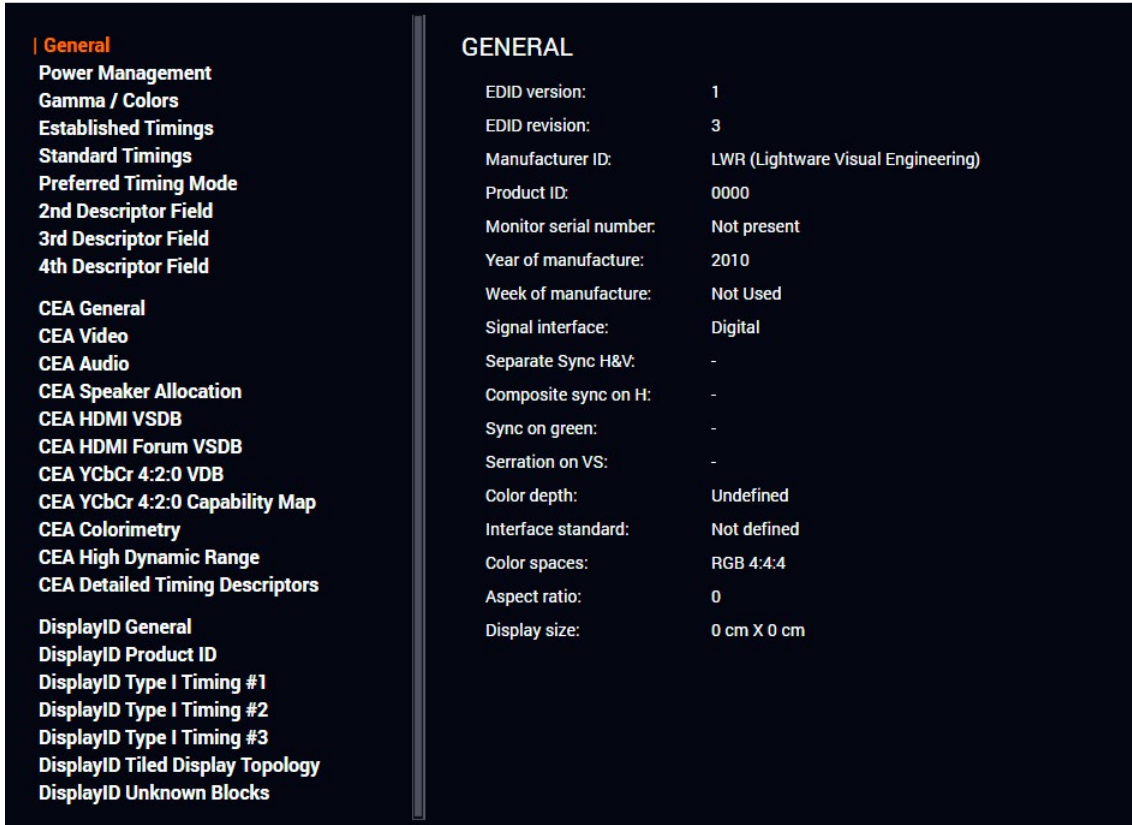

Category	Value
<b>General</b>	
Power Management	
Gamma / Colors	
Established Timings	
Standard Timings	
Preferred Timing Mode	
2nd Descriptor Field	
3rd Descriptor Field	
4th Descriptor Field	
<b>CEA General</b>	
CEA Video	
CEA Audio	
CEA Speaker Allocation	
CEA HDMI VSDB	
CEA HDMI Forum VSDB	
CEA YCbCr 4:2:0 VDB	
CEA YCbCr 4:2:0 Capability Map	
CEA Colorimetry	
CEA High Dynamic Range	
CEA Detailed Timing Descriptors	
<b>DisplayID General</b>	
DisplayID Product ID	
DisplayID Type I Timing #1	
DisplayID Type I Timing #2	
DisplayID Type I Timing #3	
DisplayID Tiled Display Topology	
DisplayID Unknown Blocks	
<b>GENERAL</b>	
EDID version:	1
EDID revision:	3
Manufacturer ID:	LWR (Lightware Visual Engineering)
Product ID:	0000
Monitor serial number:	Not present
Year of manufacture:	2010
Week of manufacture:	Not Used
Signal interface:	Digital
Separate Sync H&V:	-
Composite sync on H:	-
Sync on green:	-
Serration on VS:	-
Color depth:	Undefined
Interface standard:	Not defined
Color spaces:	RGB 4:4:4
Aspect ratio:	0
Display size:	0 cm X 0 cm

*EDID Summary Window*



### 6.11.3. Editing an EDID

Select an EDID from the Source panel and press the Edit button to display the Advanced EDID Editor window. The editor can read and write all descriptors that are defined in the standards, including the additional CEA extensions. Any EDID from the device's memory or a saved EDID file can be loaded into the editor. The software resolves the raw EDID and displays it as readable information to the user. All descriptors can be edited, saved in an EDID file, or uploaded to the User memory. For more details about EDID Editor, please visit our website ([www.lightware.com](http://www.lightware.com)) and download the [EDID Editor Application note](#).

EDIT

**Basic EDID**

- Vendor / Product Information
- Display Parameters
- Power Management and Features
- Gamma / Color and Established Timings
- Standard Timings
- Preferred Timing Mode
- 2nd Descriptor Field
- 3rd Descriptor Field
- 4th Descriptor Field
- CEA Extension
  - General
  - Video Data
  - Audio Data
  - Speaker Allocation Data
  - HDMI VSDB
  - HDMI Forum VSDB
  - YCbCr 4:2:0 VDB
  - YCbCr 4:2:0 Capability Map
  - Colorimetry
  - High Dynamic Range
  - Detailed Timing Descriptor #1
  - Detailed Timing Descriptor #2
  - Detailed Timing Descriptor #3
  - Detailed Timing Descriptor #4
  - Detailed Timing Descriptor #5
  - Detailed Timing Descriptor #6
- Display ID Extension
- Product ID
- Type I Timing Descriptor #1
- Type I Timing Descriptor #2
- Type I Timing Descriptor #3
- Tiled Display Topology
- Unknown DisplayID Data
- Save EDID

**EDID BYTE EDITOR**

	0	1	2	3	4	5	6	7	8	9
0	00	FF	FF	FF	FF	FF	FF	00	32	F2
10	00	00	00	00	00	00	00	14	01	03
20	80	00	00	78	06	EE	91	A3	54	4C
30	99	26	0F	50	54	00	00	00	01	01
40	01	01	01	01	01	01	01	01	01	01
50	01	01	01	01	02	3A	80	D0	72	38
60	2D	40	10	2C	45	80	80	38	74	00
70	00	1E	00	00	00	10	00	00	00	00
80	00	00	00	00	00	00	00	00	00	00
90	00	00	00	FD	00	31	33	37	39	0F
100	01	0A	20	20	20	20	20	00	00	00
110	00	FC	00	44	31	39	32	30	78	31
120	30	38	30	70	35	30	00	BD		

EDID Editor Window

### 6.11.4. Creating an EDID - Easy EDID Creator

Since the Advanced EDID Creator mentioned above needs more complex knowledge about EDID, Lightware introduced a wizard-like interface for fast and easy EDID creation. With Easy EDID Creator, it is possible to create custom EDIDs in four simple steps. By clicking on the **Create** button below the Source panel, **Easy EDID Creator** is opened in a new window. For more details about the EDID Editor, please visit our website ([www.lightware.com](http://www.lightware.com)) and download the [EDID Editor Application note](#).

CREATE

**Select Resolution & Interface**

**Video Format**

**Audio Format**

**Finish**

Back Next

**SELECT RESOLUTION & INTERFACE**

Welcome to the Easy EDID Creator!

With this software you are able to create a unique EDID according to your demands. Details can be added or changed in the Advanced EDID Editor later if needed.

Please select the format type and the preferred resolution. If you don't find the proper mode in the list, use the Custom format type setting, enter the resolution and the program will estimate the best blanking times.

**Important notes:**

- If you want to send audio then you must select HDMI or DisplayPort. DVI and VGA do not support audio transmission.
- Most DVI displays are not able to process HDMI signals. If you have a DVI display, please check its specifications.
- The supported color depth will be 24bits/pixel by default.
- USB TYPE-C means DisplayPort interface over a different physical interface.

Format type: Broadcast

Resolution: 640x480p60

Interface type:
 

- VGA
- DVI
- HDMI**
- DisplayPort
- USB TYPE-C

EDID Creator Window

## 6.12. Control Menu

### 6.12.1. Ethernet

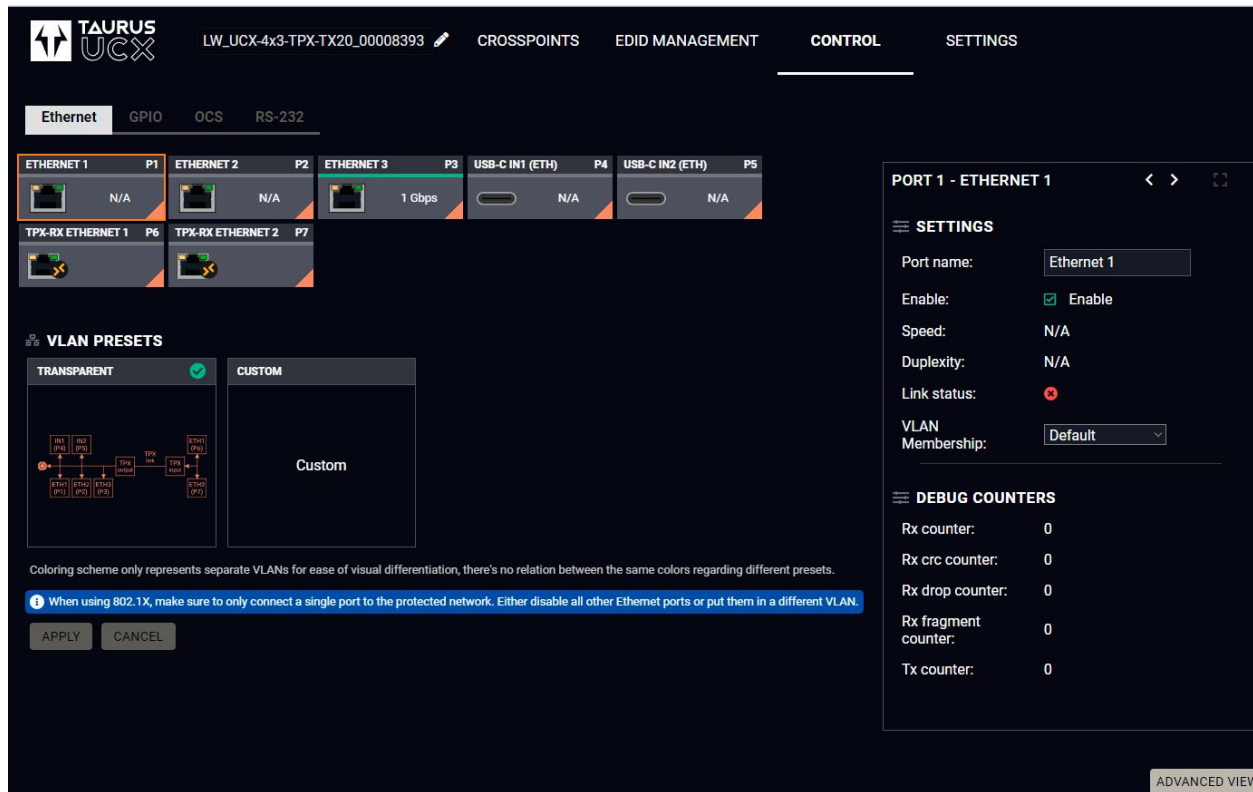

**Ethernet tab in Control menu**

Several ports are displayed in the Ethernet settings: Three of them belong to the RJ45 Ethernet connectors. You can check the status of the Ethernet line by each port: the speed and the duplexity of the connection. Two are for configuring the Ethernet layer in the USB-C ports. The remaining two ports are for checking the status of the Ethernet connectors of the RX.

The following settings are available for each port:

- Rename the port,
- Enable / disable the port;
- VLAN membership.

#### VLAN Membership

The VLAN membership setting offers isolated networks for the chosen ports that are independent from the management network and even each other. In case the VLAN membership setting of any port is changed, the VLAN preset will be **Custom**. Further management options will be implemented in a later firmware update.

**INFO:** The VLAN membership setting is only available for TPX-TX devices.

### 6.12.2. GPIO

**DIFFERENCE:** The HDMI-UCX-TPX-RX107 receiver does not have a GPIO port.

The GPIO port has 6 pins, which operate at TTL digital signal levels and can be controlled by LDC or protocol commands. Select a GPIO pin under the Port settings section; the settings (pin direction and input level) are displayed on the port tiles as well. #gpio

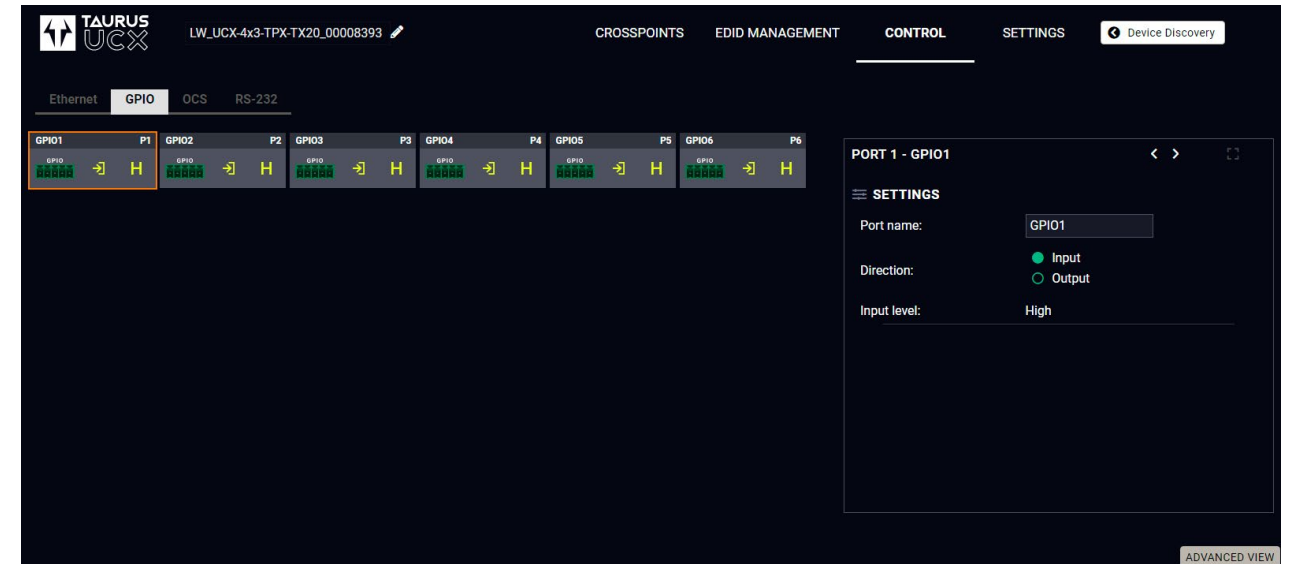

**INFO:** Output level can be set only if the pin direction is set to Output. In case of input direction, the output level setting and the **Toggle** button is not available.

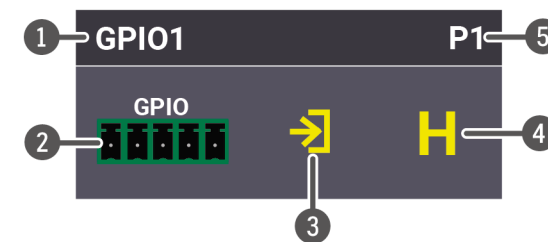

- 1 GPIO pin name
- 2 GPIO Port symbol
- 3 Pin direction:  
 Input  
 Output
- 4 Level indicator:  
**L:** Low  
**H:** High
- 5 GPIO Port number

#### Interval

Interval section is designed for setting the chosen GPIO pin to the specified level for a specified time. Configure the **Duration** time and the **Logic level** of the desired value. Confirm by clicking the **Set interval** button.

### 6.12.3. OCS - Occupancy Sensor

**DIFFERENCE:** The UCX-4x3-TPX-TX20 and UCX-2x1-TPX-TX20 transmitters do not have an OCS port, however they can control the OCS port of the HDMI-UCX-TPX-RX107 receiver.

The OCS sensor has 3 pins, where the first pin is a 24V logic input. The default state is high. Different type of sensors exist: some send high level, some send low level to this input when the room is occupied. Active-high or active-low logic might be configured for this port in LDC to support them.

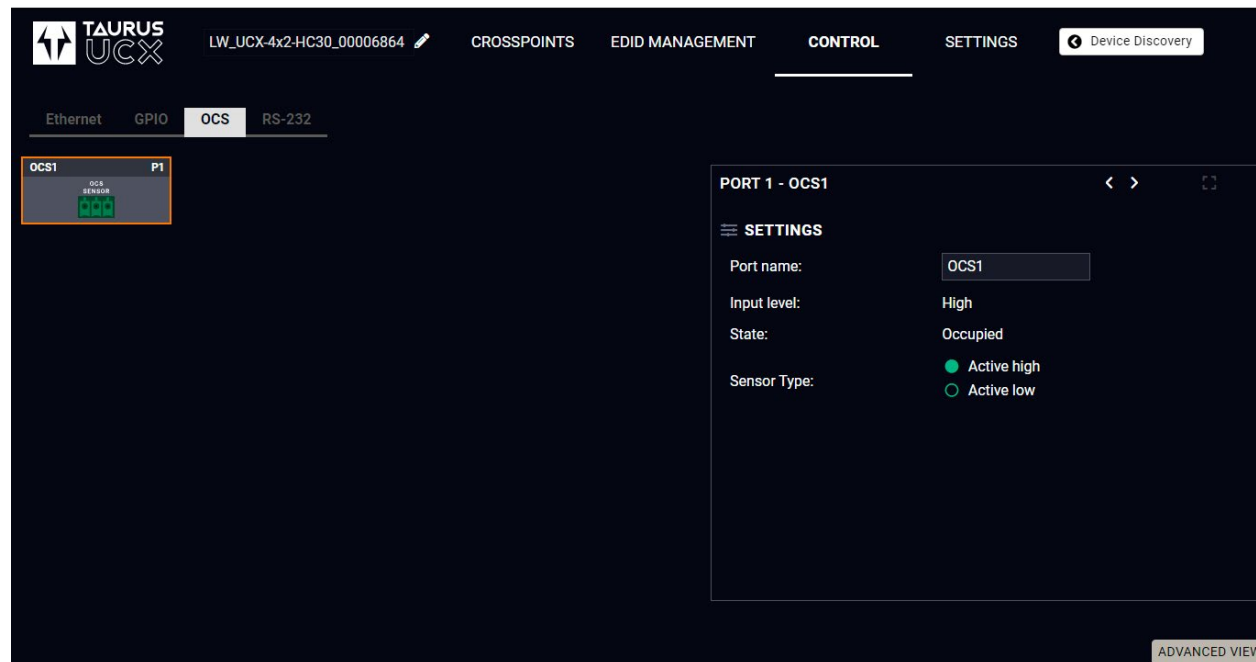

**Input level** refers to the current input signal level of the first pin.

**State** value can be free or occupied, depending on the Sensor type setting and the Input level (e.g. when the sensor type is Active high and the input value is high, the state reports 'Occupied').

**Sensor type** can be active high/active low, and this defines whether the low or high input level means the occupancy.

#ocs

### 6.12.4. RS-232

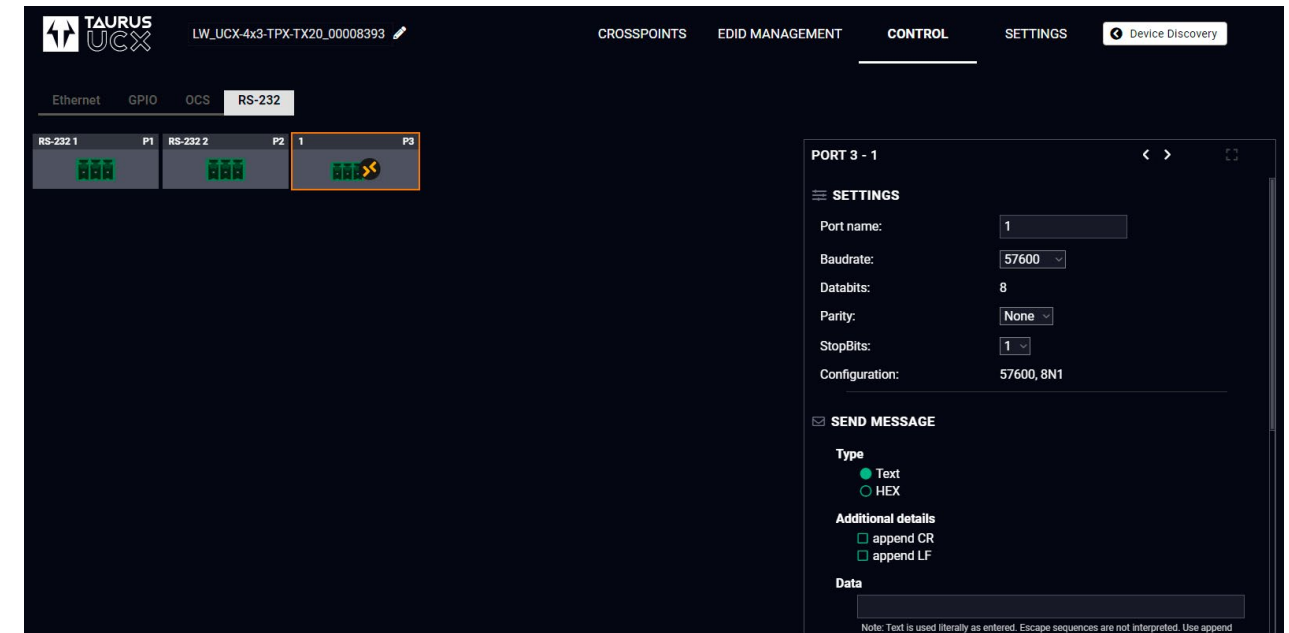

RS-232 tab in Control menu

The following settings and functions are available: #rs-232 #serial

- **Baud rate:** 9600, 14400, 19200, 38400, 57600, 115200;
- **Data bits:** 8;
- **Parity:** None, Odd, or Even; #rs232

## Send Message Section

The serial message sending is achieved by Lightware REST API, and it can be in text or hexadecimal format. The CR/LF (Carriage Return/Line Feed) can be enabled optionally.

### PORT 1 - RS-232 1

<
>
⌵

**SEND MESSAGE**

**Type**

Text

HEX

**Additional details**

append CR

append LF

**Data**

Note: Text is used literally as entered. Escape sequences are not interpreted. Use append function to configure EOL characters. ASCII Characters between codes 0x20 and 0x7E are allowed in LDC. REST API Serial Send function has no character type limit. It accepts either text/plain or application/binary content.

**Compiled data**

Data input is empty

SEND

**Local send history**

Timestamp	Data	Status
10:00:27	123	✔

Use HTTP(S) Post for sending from an external controller:  
POST 172.24.5.39/api/V1/MEDIA/SERIAL/P1/send  
Disabling SolP has no influence on Send function.

## 6.13. Settings Menu

### 6.13.1. TX Status

#deviceLabel #label #producttype #firmwareversion #status #serialnumber

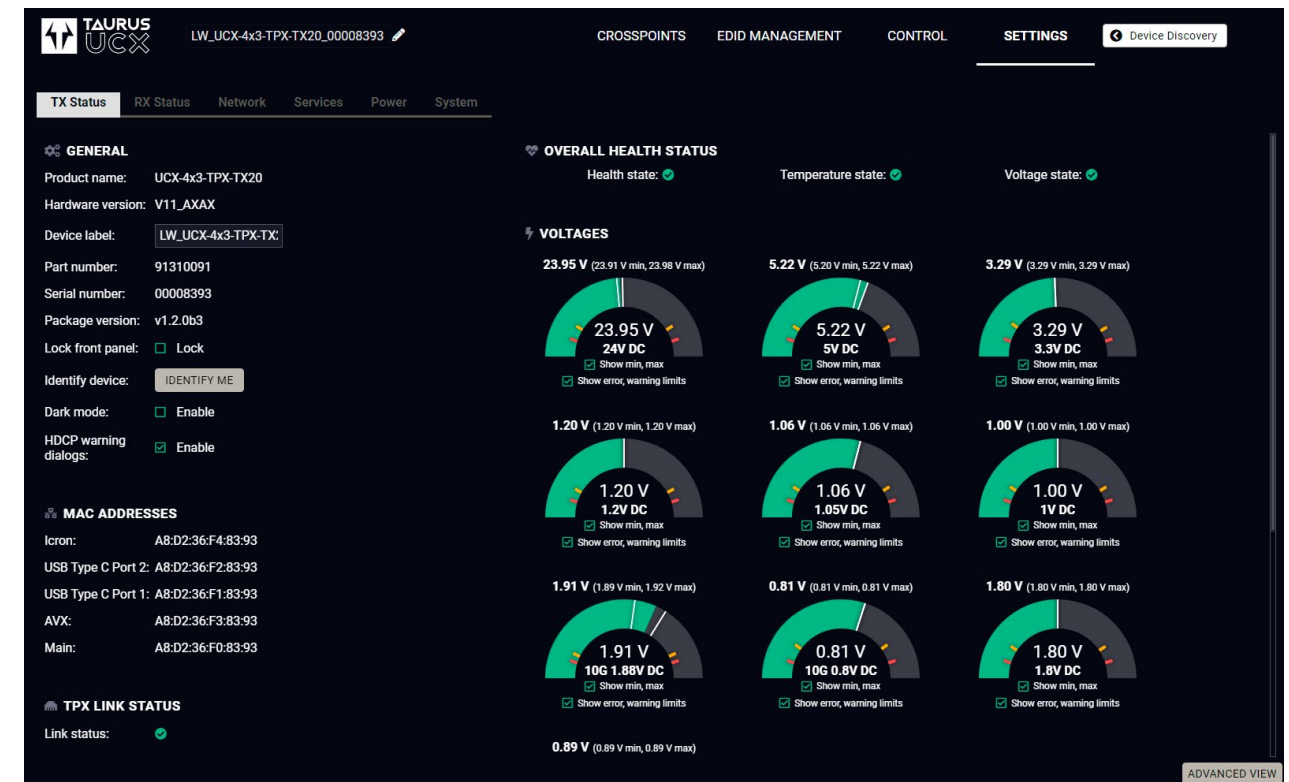

#### TX Status tab in the Settings menu

The most important hardware and software related information can be found on this tab: hardware and firmware version, serial numbers, MAC addresses, temperatures, and voltage information. Device label can be changed to a unique description by the **Set** button. #buttonlock #lockbutton

You can disable the functionality of the front panel buttons by marking the Lock front panel option. This is same method of the control lock enabled by the front panel buttons. See the details in the [Control Lock](#) section.

Clicking on the **Identify me** button results in the blinking of the status and crosspoint LEDs in green for 10 seconds. The feature helps to identify the device itself in the rack shelf.

**Dark mode enable:** When Dark mode is enabled, all LEDs on the unit are switched off (after 60 seconds by default) if no buttons are pressed. Pressing any button brings back the status info on the LEDs without performing the function of the button itself. #darkmode

TPX link status can also be seen.

### 6.13.2. RX Status

**DIFFERENCE:** This tab is only available when the receiver is HDMI-UCX-TPX-RX107.

The screenshot displays the 'RX Status' tab within the 'SETTINGS' menu. The top navigation bar includes 'CROSSPOINTS', 'EDID MANAGEMENT', 'CONTROL', and 'SETTINGS'. Below this, there are sub-tabs for 'TX Status', 'RX Status', 'Network', 'Services', 'Power', and 'System'. The 'RX Status' tab is active, showing a 'GENERAL' section with fields for Product name (HDMI-UCX-TPX-RX107), Device label (00008398), Part number (91580010), Serial number (00008398), and Package version (v2.4.0b8). A 'MAC ADDRESSES' section shows MAC Address #1: A8-D2-36-F0-83-98. A 'TPX LINK STATUS' section shows 'Link status: [green checkmark]'. Two temperature gauges are visible: 'AVX Temp' at 58.00 °C (range 37.00 °C min, 61.00 °C max) and '10G PHY Temp' at 65.00 °C (range 0.00 °C min, 70.00 °C max). Both gauges have 'Show min, max' and 'Show error, warning limits' checkboxes. An 'ADVANCED VIEW' button is located at the bottom right.

*RX Status tab in the Settings menu*

The most important software related information can be found on this tab: firmware version, serial numbers, MAC address and temperatures. Device label can be changed to a unique description by the **Set** button.

TPX link status can also be seen.

### 6.13.3. Network

The screenshot displays the 'Network' tab within the 'SETTINGS' menu. The top navigation bar includes 'CROSSPOINTS', 'EDID MANAGEMENT', 'CONTROL', and 'SETTINGS'. Below this, there are sub-tabs for 'TX Status', 'RX Status', 'Network', 'Services', 'Power', and 'System'. The 'Network' tab is active, showing 'NETWORK SETTINGS' with fields for Current IP address (192.168.0.131), Current subnet mask (255.255.255.0), Current gateway address (192.168.0.1), Host name (lightware-00008393), and checkboxes for 'Obtain IP address automatically (DHCP, AutoIP)', 'Static IP address' (192.168.0.100), 'Static subnet mask' (255.255.255.0), and 'Static gateway address' (192.168.0.1). There are 'APPLY CHANGES' and 'CANCEL' buttons at the bottom. The '802.1X CONFIGURATION' section has 'Enable 802.1X' checked, 'Authentication method' set to 'EAP-MD5', and 'APPLY NEW CONFIGURATION' and 'CANCEL' buttons. A blue warning box states: 'When using 802.1X, make sure to only connect a single port to the protected network. Either disable all other Ethernet ports or put them in a different VLAN.' The '802.1X STATUS' section shows 'WPA Supplicant Status' as disabled and a 'Show more status details (for debug purposes)' checkbox.

*Network tab in Settings menu*

#### Network Settings

IP address and DHCP settings can be set on this tab. Always press the **Apply settings** button to save changes.

When the host name is modified, clicking on the **Restart http(s) services** button is also needed.

**INFO:** A new certificate is generated after the hostname changing.

#### 802.1x Configuration

##### Authentication Process

You will find the 802.1x authentication section in the right.

You can enable authentication by ticking in the Enable box. Once 802.1x authentication is enabled, you can choose the authentication method from the drop-down menu: **EAP-MD5** or **EAP-TLS**.

**DIFFERENCE:** From firmware version v1.9.0, EAP-MD5 authentication is unavailable.

When using EAP-MD5, authentication will require an Identity and a Password to gain access to the secure network.

The screenshot shows the '802.1X CONFIGURATION' section. 'Enable 802.1X' is checked. 'Authentication method' is set to 'EAP-MD5'. There are input fields for 'Identity\*' and 'Password\*', with a 'Show password' checkbox. 'APPLY NEW CONFIGURATION' and 'CANCEL' buttons are at the bottom. A blue warning box is present: 'When using 802.1X, make sure to only connect a single port to the protected network. Either disable all other Ethernet ports or put them in a different VLAN.' Below this is the '802.1X STATUS' section with 'WPA Supplicant Status' as disabled and a 'Show more status details (for debug purposes)' checkbox.

With EAP-TLS, you will also need CA and Client certificates, a Client Private Key, and a password for the Key.

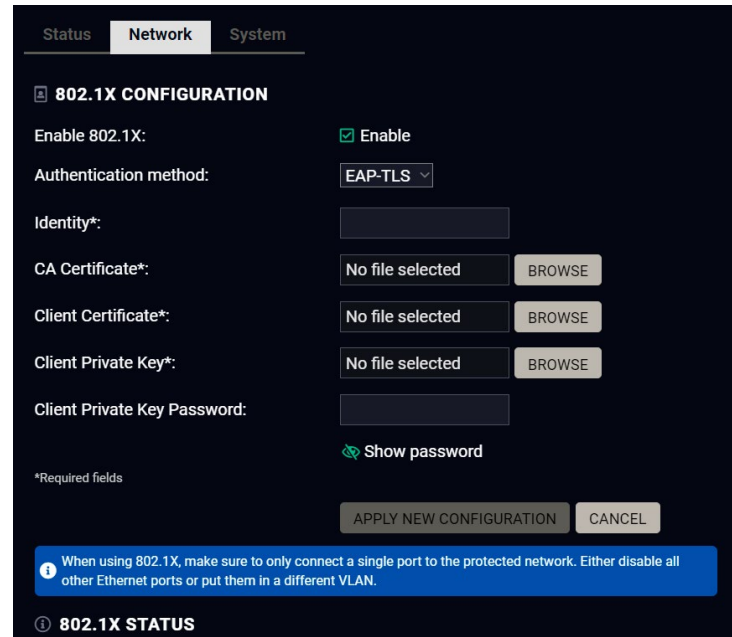

After entering every necessary information, click on the **Apply new configuration** button, and the authentication process starts.

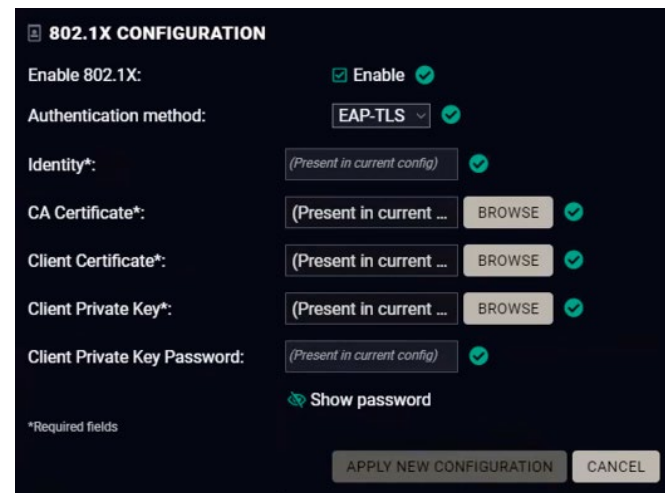

If every component is correct, the device will gain access to the secure LAN.

### 6.13.4. Services

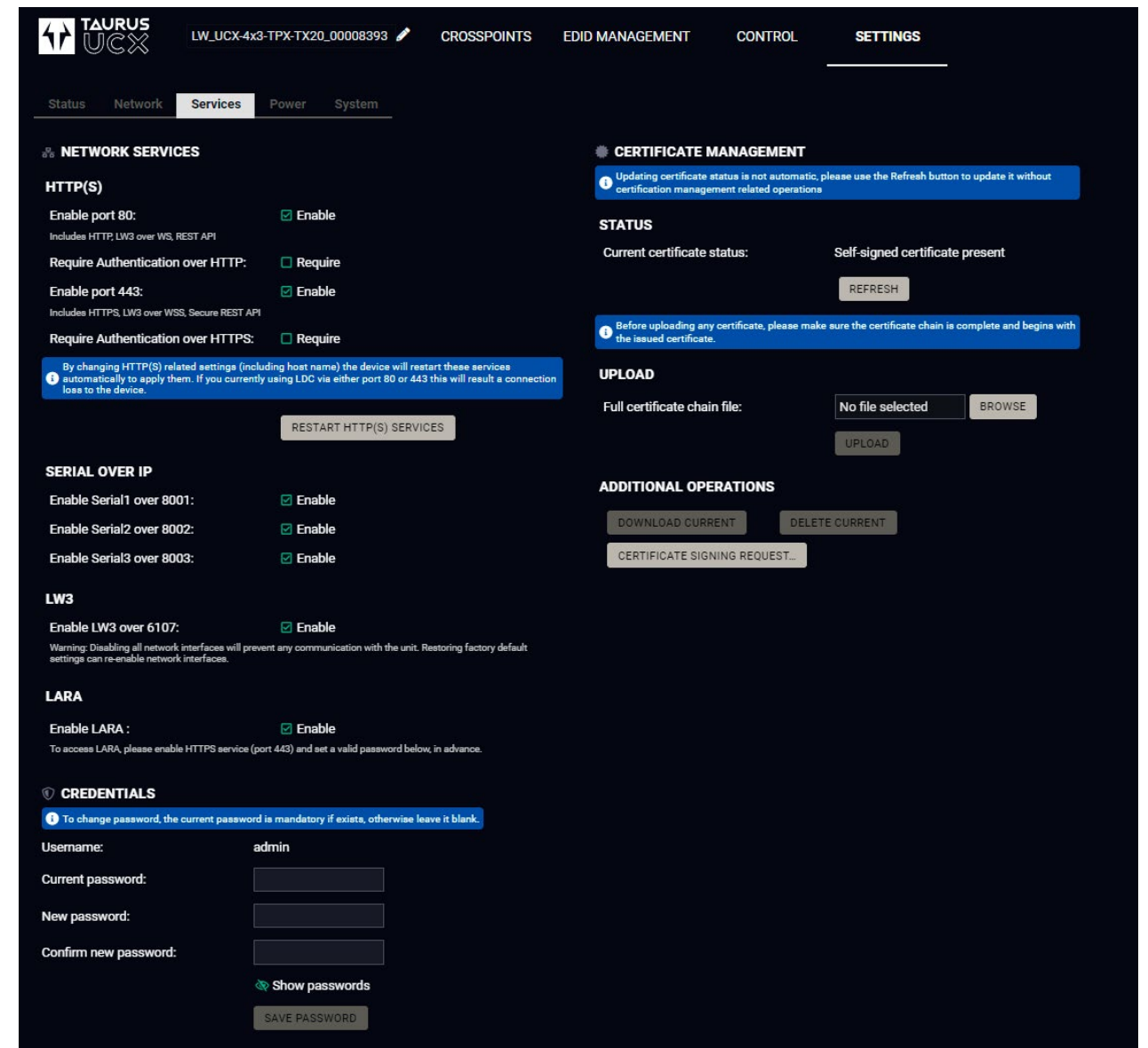

#### Network Services

##### HTTP/HTTPS

UCX-TPX series switcher transmitter provides HTTP/HTTPS server services on its 80 and 443 ports to make it accessible over WebSocket (WS), LW3 protocol, using Lightware Device Controller and REST API for device control (see the detailed list about the additional available features in the summary table of the [Lightware Advanced Room Automation \(LARA\)](#) section).

HTTPS protocol encrypts the transferred data to keep it protected. For more details about the HTTPS, see the [Encryption \(HTTPS, WSS\)](#) section. `#portblock` `#network` `#http` `#https`

- **Enable/Disable HTTP/ HTTPS port:** To ensure the secure data traffic, the HTTP port (80) can be disabled, and the all the information can be transferred via HTTPS (443 port).

80 or 443 port is necessary to upload/download WelcomeScreen image, log and clone files so one of them should be opened to reach these functions.

**ATTENTION!** Please ensure proper UCX time and date setting in UCX, because it affects the self-signed certificate (SSL) generation when using WSS or HTTPS. Improper time and date setting may lead to certificate rejection.

- **Require Authentication over HTTP/HTTPS:** authentication helps limit the access to the device by setting a username (admin) and a password. For more details, see the [Basic Network Security](#) section. No password is set by default, the authentication can be enabled after setting a password.
- **Restart HTTP(S) Services** is required after the authentication settings changed.

### Serial over IP

The signal route of the serial-IP transmission can be broken by disabling the serial over 8001 or 8002 port. For more details about the RS-232, see the [Serial Interface](#) section.

### LW3

**Enable LW3 over 6107:** LW3 protocol commands, Lighthouse Device Controller software.

**WARNING!** The Lightware Device Controller software operates on 6107 port, when it is disabled, the UCX-TPX series switcher transmitter can be controlled only with protocol commands via http(s). [Reset to Factory Default Settings](#) can re-enable the network interfaces.

### LARA

LARA can be enabled by ticking in the box after enabling HTTPS and setting a password, which can be done below.

### Credentials

**DIFFERENCE:** From firmware version v1.8.0 and LDC version v2.8.0, password history is maintained in authentication, not allowing for the last 10 passwords to be set again.

The authentication password can be set here for HTTP/HTTPS ports. UTF-8 characters are allowed. Min length: 10 characters, max length: 100 characters. The password string can not be queried. `#password`

**ATTENTION!** If a wrong password is entered during login five times in a row, all login attempts are denied for 15 minutes.

### New Password

**INFO:** The old password is also required when changing the password.

**ATTENTION!** Authentication feature in UCX-TPX series is not equal to the Cleartext login feature in the Advanced Control Pack in the TPS family extenders.

### Certificate Management

You can upload certificates signed by the Certificate Authority (CA) to provide secure connection to the devices with the webLDC.

To download a Certificate Signing Request (CSR), follow these steps:

- Step 1.** Navigate to the Settings menu, Services tab and click on the **Certificate Signing Request** button.
- Step 2.** Enter the data required for the authentication process. It is important to provide all information related to your organization, because it will be used to verify your identity.
- Step 3.** Once all the necessary data has been entered, the file can be downloaded via the button in the bottom, and sent for signing.
- Step 4.** When the CA signs the certificate, it will create a .pem file, which then can be uploaded onto the device.
- Step 5.** After uploading, press the **Refresh** button in the Certificate Management section and the signed certificate shall be active.

Please be aware that the certificate will use the device's own private key and will not work for any other device. Each device must have its own certification.

**DOWNLOAD CERTIFICATE SIGNING REQUEST**

Updating CSR parameters based on the installed certificate is automatic when the page loads, in any other case please use the 'Load CSR info/Refresh' button to update it.

Get CSR field informations from current certificate:

Common Name:

Organization Name:

Organizational Unit:

Locality:

State:

Country:

Email Address:

Subject Alt Name(s):

*The certificate signing request form*

Information	Description	Example
Common Name	The domain name you wish to secure.	www.example.com
Organization Name	The legal name of the company or organization, any suffix included.	Lightware Visual Engineering PLC
Organizational Unit	The name of the internal organizational department/division.	IT
Locality	The name of the city, town, village etc. of the organization.	Budapest
State	Province, region, county or state, not abbreviated.	Pest county
Country	The country of the organization can be chose from the drop-down menu.	Hungary
Email Address	The contact address of the certificate administrator or the IT department of the company.	example@lightware.com

In the Subject Alt Name(s) field you can enter additional information for more hosts to be certified with one SSL file. The information type can be chosen from the drop down menu. You can have several Subject Alt Name fields.

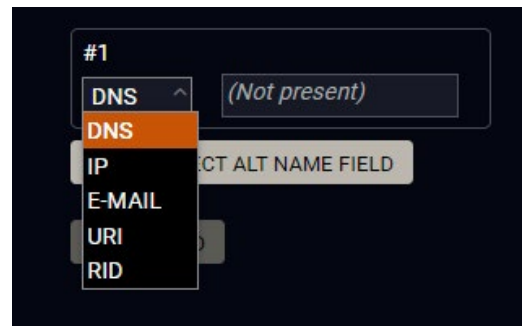

You can enter the following information in the Subject Alt Name field:

- DNS
- IP address
- E-mail address
- URI
- RID

### 6.13.5. Power

**POWER BUDGET INFORMATION**

Total Power Budget	150 W
Unreserved Power Budget	30 W
Unallocated Power Budget	30 W

**POWER DISTRIBUTION SETTINGS**

	TPX PoE	USB-C Port U1	USB-C Port U2
Reserved Power	30 W	60 W	30 W
Power Allocation Mode	-	Static	Static
Allocated Power	30 W	60 W	30 W

**OVERALL POWER USAGE**

TPX PoE | USB-C Port U1 | USB-C Port U2 | Unallocated

**Power tab in the Settings menu**

On this tab you can set the power output by each capable port.

#### Power Budget Information

- **Total Power Budget:** you can see the full amount of power available for output.
- **Unreserved Power Budget:** you can see the amount of power that remains after the amount has been set on all ports.
- **Unallocated Power Budget:** you can see the amount of power that remains available in case one of the Power Allocation Mode on a port is set to Auto. If needed, this power amount will be automatically provided for the port.

#### Power Distribution Settings

In this table you can quickly and efficiently set the power capabilities of each port.

- **Reserved Power:** You can choose a minimum amount of power to be output on the port from a drop-down menu.
- **Power Allocation Mode:** You can set whether the port shall be capable of outputting more than the minimum amount set in the line above. In case of **Static**, the port will output the set amount. In case of **Auto**, the port may use any unallocated power in addition to the given minimum to supply to the device connected to it if needed.
- **Allocated Power:** total amount of power output by the port.



### Enabling 100W power to first connected device

In order for a USB-C port to be able to supply 100W, the amount of reserved power must be sufficient. If the user wants to allocate 100W to the first connected device, regardless of which USB-C port it is connected to, the setting must be arranged as follows:

#### PoE On

- Step 1.** Make sure that **Power Allocation Mode** for all ports is **Static**.
- Step 2.** Choose **30W** of **Reserved Power** for the TPX PoE column.
- Step 3.** Set the **Reserved Power** for both USB-C ports to **15W**.
- Step 4.** Turn **Power Allocation Mode** to **Auto** for the USB-C ports.

This will enable the transmitter so supply the first connected device with up to 100W, while the other port will be able to supply 20W.

#### PoE Off

- Step 1.** Make sure that **Power Allocation Mode** for all ports is **Static**.
- Step 2.** Choose **0W** of **Reserved Power** for the TPX PoE column.
- Step 3.** Set the **Reserved Power** for both USB-C ports to a maximum of **30W**.
- Step 4.** Turn **Power Allocation Mode** to **Auto** for the USB-C ports.

This will enable the transmitter so supply the first connected device with up to 100W, while the other port will be able to supply 50W.

### 6.13.6. System

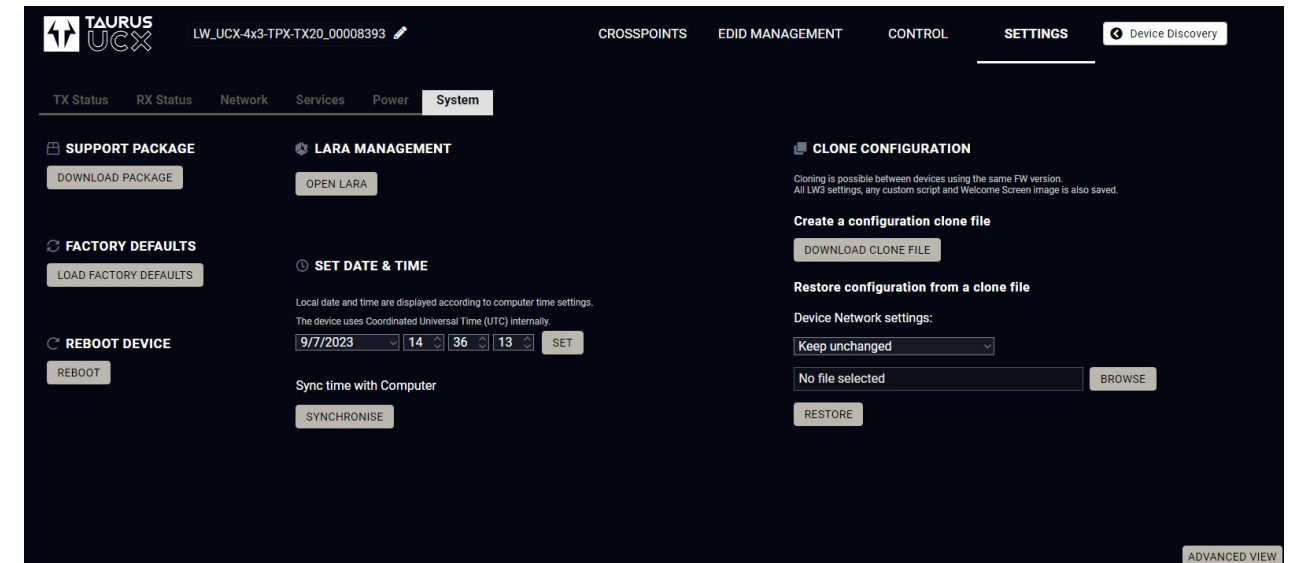

**System tab in Settings menu**

The following functions are available under the System tab:

- **Support package** - saving a log file of the device, helps during the troubleshooting process
- **Load factory defaults** - recalling factory default settings and values. All factory default settings are listed in the [Content of the Backup File](#) section.
- **Reboot** - rebooting the system.
- **Set time** - (internal clock) of the switcher, which is used for logging events.
- Pressing the **Sync with Computer** button is a quick and easy way to set the time. *#factory #log #systemlog #reboot #restart*

**ATTENTION!** Please ensure proper UCX time and date setting in UCX, because it affects the self-signed certificate (SSL) generation when using WSS or HTTPS. Improper time and date setting may lead to certificate rejection.

## LARA management

The LARA interface can be opened by clicking on the Open LARA button.

## Clone configuration

Clone configuration makes saving all the LW3 settings, custom scripts and welcome screen image and uploading them to another device possible.

**ATTENTION!** Please note that clone configuration function operates properly when the same firmware version is installed on the devices.

**ATTENTION!** If the device that the clone configuration is created on is password protected, the devices where this file is uploaded will also ask for a password. However, as passwords are not saved in the configuration file, the password is reset to **admin**.

### Create a configuration clone file

Click on the **Download Clone File** button to save the setting to the computer.

### Restore a configuration from a clone file

**Step 1.** Choose the desired network setting from the drop down menu:

- Keep unchanged.
- Restore from clone file (hostname will change, because the hostname property is also cloned from the original device and it can affect the generated certificates of the 443 port).
- Set to DHCP mode.
- Set to custom non-DHCP mode (in this case additional settings required: IP Address, Subnet Mask, Gateway Address).

**INFO:** The network settings relates to Static or DHCP setting/ IP address/ Subnet mask/ Gateway address and the hostname property. Network service settings (enable http(s) ports, authentication etc.) will be always restored.

**Step 2.** Click on the **Select file** button to browse a clone file from the PC.

**Step 3.** The cloning process will start by clicking on the **Restore** button.

See the entire list of the saved data in the backup file in the [Content of the Backup File](#) section.

## 6.14. Advanced View Window

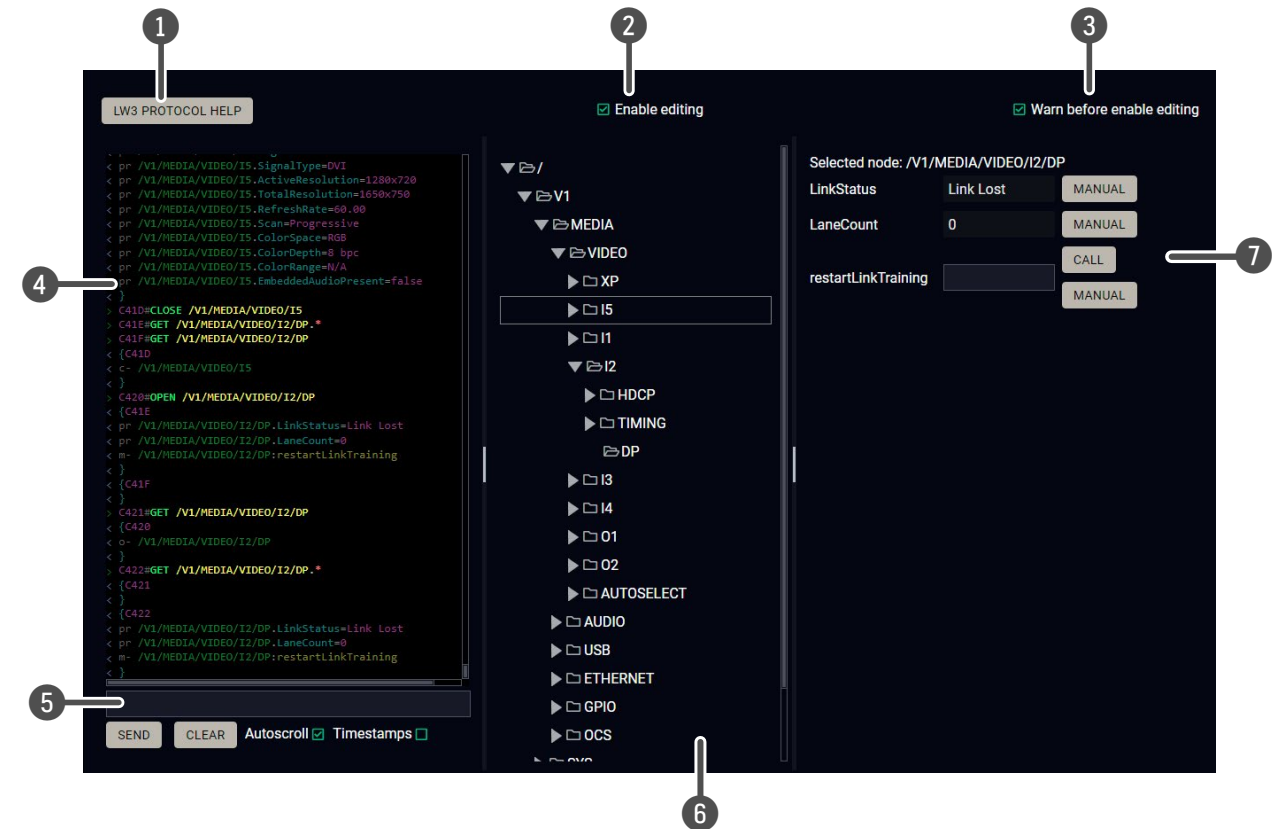

- 1 **LW3 protocol help** Pushing the button results in a help window opening, which describes the most important information about LW3 protocol commands in HTML format.
  - 2 **Edit mode** The default appearance is the read-only mode. If you want to modify the values or parameters, tick the option. You will be prompted to confirm your selection.
  - 3 **Warning mode** If this is checked, a warning window pops up when you enable Edit mode.
  - 4 **Terminal window** Commands and responses with time and date are listed in this window. Sent command starts with '>' character, received response starts with '<' character. The color of each item depends on the type of the command and response. The content of the window can be emptied by the **Clear** button. If the **Autoscroll** option is ticked, the list is scrolled automatically when a new line is added.
  - 5 **Command line** Type the desired command and execute it by the **Send** button. Clear all current commands and responses in the Terminal window by the **Clear** button.
  - 6 **Protocol tree** LW3 protocol tree; select an item to see its content.
  - 7 **Node list** Correspondent parameters and nodes are shown that are connected to the selected item in the protocol tree.
- #advancedview*  
*#terminal*
- Manual** button: Manual (short description) of the node can be called and displayed in the terminal window.
- Set** button: Saves the value/parameter typed in the textbox.
- Call** button: Calls the method, e.g. reloads factory default settings.

# 7

## Lightware REST API Reference

The device can be controlled through standard HTTP(S) requests to ensure the control functions from web browsers or terminal program.

- ▶ [OVERVIEW](#)
- ▶ [INSTRUCTIONS FOR THE TERMINAL APPLICATION USAGE](#)
- ▶ [PROTOCOL RULES](#)
- ▶ [REST API SECURITY](#)
- ▶ [SYSTEM COMMANDS](#)
- ▶ [VIDEO PORT SETTINGS - GENERAL](#)
- ▶ [WELCOME SCREEN SETTINGS](#)
- ▶ [VIDEO PORT SETTINGS - USB-C RELATED COMMANDS](#)
- ▶ [CEC COMMAND SENDING](#)
- ▶ [AUDIO PORT SETTINGS](#)
- ▶ [USB PORT SETTINGS](#)
- ▶ [USB PORT SETTINGS - USB-C RELATED COMMANDS](#)
- ▶ [EDID MANAGEMENT](#)
- ▶ [ETHERNET PORT CONFIGURATION](#)
- ▶ [NETWORK SECURITY](#)
- ▶ [SERIAL PORT CONFIGURATION](#)
- ▶ [SERIAL PORT MESSAGING](#)
- ▶ [GPIO PORT CONFIGURATION](#)
- ▶ [OCS PORT CONFIGURATION](#)
- ▶ [UPDATING THE DEVICE VIA REST API](#)
- ▶ [LIGHTWARE REST API QUICK SUMMARY](#)

## 7.1. Overview

The Lightware REST API is designed to provide a platform-free interface, where the UCX series switcher transmitter can be controlled by HTTP requests. REST API is a software architectural style based on HTTP protocol, so it can be used via web browser, Node.js, terminal programs.

The UCX-TPX series device provides a REST API server where most of the LW3 commands are available (for more details, see the [Lightware REST API vs. LW3 Protocol](#) section).

Lightware devices can be controlled with LW3 protocol commands (for more details, see the [LW3 Programmers' Reference](#)). LW3 protocol consists of read-only, read-write properties and methods, which operate in the same way as REST API GET/POST methods. This is not a new protocol, the LW3 tree structure became available via HTTP(s).

## 7.2. Instructions for the Terminal Application Usage

### 7.2.1. Third-party API Platform

Postman is one of the numerous applications that can be used for sending REST API requests.

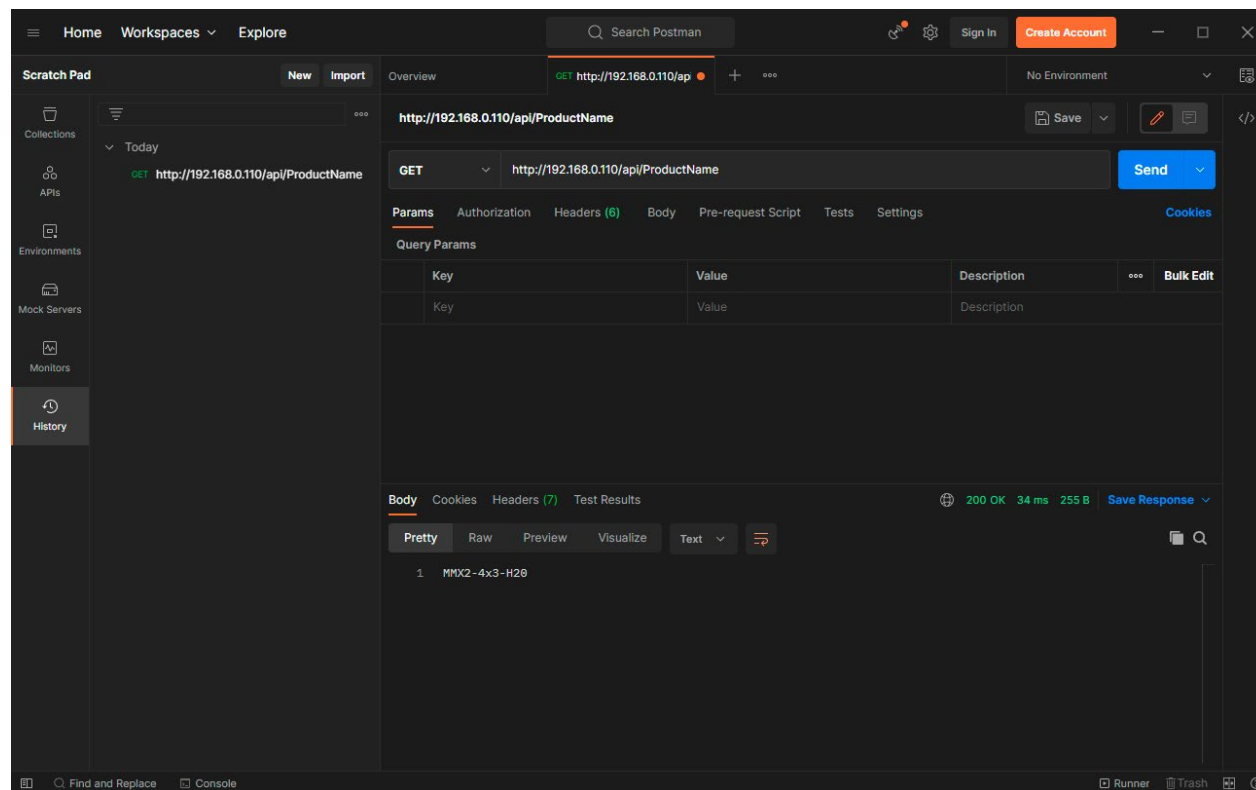

**Postman – for REST API Usage**

### 7.2.2. Terminal Application

The REST API requests can be applied to the switcher transmitter using a terminal application. You need to install one of them on your control device, for example, Putty, CLI or Curl. *#terminal*

#### Curl

**Curl** is a command line tool that can also connect to the Taurus REST SERVER and display communication in a terminal window. It supports data transferring with HTTP and HTTPS standards and handles the basic authentication (username and password) in Windows® and Linux operating systems. Multi-line commands are also accepted, so a script can be stored in a .txt file for future reference.

Check if the Curl package is installed on your system. Type into your console: `curl`. When the answer is `'curl: try 'curl --help' for more information'`, curl is installed.

Some web browser plugins (e.g. REST Client) display the curl version of the sent request.

Once the terminal window is opened, you can enter the commands. Some typical examples are listed in the following section.

```

C:\>curl -i -X GET http://192.168.0.110/api/V1/MEDIA/VIDEO/XP/I2/SignalPresent
HTTP/1.1 200 OK
Content-Type: text/plain; charset=utf-8
Content-Length: 5
ETag: W/"5-fLbvuyullyqbUJdCLlF/4U0SywQ"
Date: Tue, 25 Apr 2023 09:15:05 GMT
cache-control: no-cache,private
Accept-Ranges: bytes
Server: Lightware webservice

false
C:\>curl -i -X POST http://192.168.0.110/api/V1/MEDIA/GPIO/P1/interval --data Low;1
HTTP/1.1 200 OK
Content-Type: text/plain; charset=utf-8
Content-Length: 2
ETag: W/"2-n009QiTIwXgNtWtBJezz8kv3SLc"
Date: Tue, 25 Apr 2023 09:15:35 GMT
cache-control: no-cache,private
Server: Lightware webservice

OK
C:\>

```

**REST API communication in a command line window**

**GET Command Example**

Query the Signal Presence

```
curl -i -X GET <ip>/api/<NodePath>/<PropertyName>
```

```
C:\>curl -i -X GET http://192.168.0.55/api/V1/MEDIA/VIDEO/XP/I2/SignalPresent
HTTP/1.1 200 OK
X-Powered-By: Express
Content-Type: application/json; charset=utf-8
Content-Length: 5
ETag: W/"5-fLbvuyullyqbUJdcl1F/4U0SywQ"
Date: Sat, 13 May 2034 13:39:24 GMT
cache-control: max-age=86400,private
Server: lighttpd/1.4.56

false
```

**POST Command Example 1.**

Set the Mute State

```
curl -X POST -i <ip>/api/<NodePath>/<PropertyName> --data <value>
```

```
C:\>curl -X POST -i http://192.168.0.55/api/V1/MEDIA/VIDEO/XP/I2/Mute --data true
HTTP/1.1 200 OK
X-Powered-By: Express
Content-Type: text/html; charset=utf-8
Content-Length: 5
ETag: W/"5-hg914ZeUflab5o9bn2uUeaPo3CI"
Date: Sat, 13 May 2034 13:48:09 GMT
cache-control: max-age=86400,private
Server: lighttpd/1.4.56

true
```

**POST Command Example 2.**

Switch video crosspoint

```
curl -X POST -i <ip>/api/<NodePath>/<PropertyName> --data <value>
```

```
C:\>curl -X POST -i http://192.168.0.55/api/V1/MEDIA/VIDEO/XP/switch --data I2:01
HTTP/1.1 200 OK
X-Powered-By: Express
Content-Type: text/plain; charset=utf-8
Content-Length: 2
ETag: W/"2-n009QiTiwXgNtWtBJezz8kv3SLc"
Date: Sat, 13 May 2034 14:02:01 GMT
cache-control: max-age=86400,private
Server: lighttpd/1.4.56

OK
```

**POST Command with Basic Authentication Example**

Switch video crosspoint

```
curl --user <username>:<password> -X POST -i <ip>/api/<NodePath>/<PropertyName>
--data <value>
```

```
C:\>curl --user admin:pwd -X POST -H -i http://192.168.0.110/api/V1/MEDIA/VIDEO/XP/switch
--data I2:01

OK
```

**HTTPS Command Example 2.**

Switch video crosspoint

```
curl -X POST -k -i <ip>/api/<NodePath>/<PropertyName> --data <value>
```

```
C:\>curl -X POST -k -i https://192.168.0.110/api/V1/MEDIA/VIDEO/XP/switch --data I2:01
HTTP/1.1 200 OK
X-Powered-By: Express
Content-Type: text/plain; charset=utf-8
Content-Length: 2
ETag: W/"2-n009QiTiwXgNtWtBJezz8kv3SLc"
Date: Sun, 28 May 2034 12:28:20 GMT
cache-control: max-age=86400,private
Server: lighttpd/1.4.56

OK
```

### 7.3. Protocol Rules

#### 7.3.1. Command Structure Example

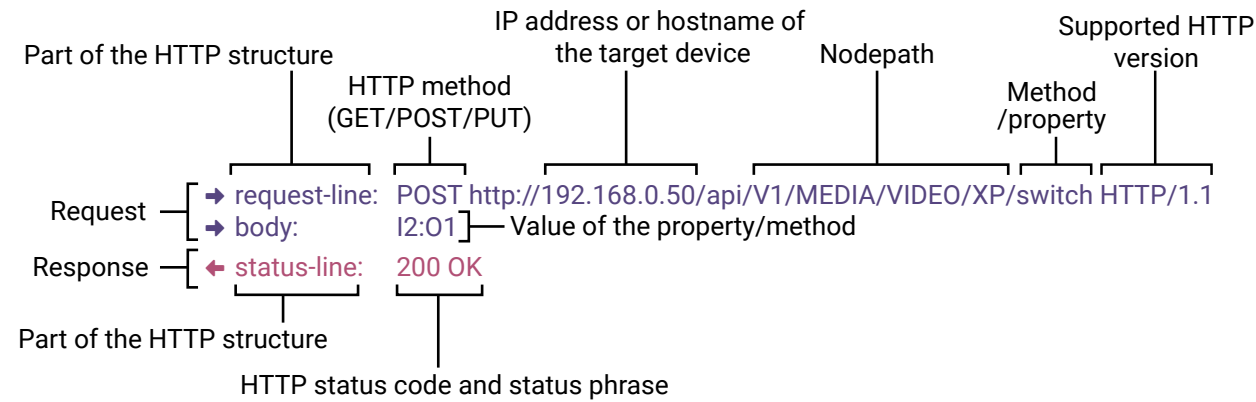

The examples below show how to apply the REST API in different environments:

#### Curl in Command Line Terminal

```
➔ curl -X POST -i http://192.168.0.55/api/V1/MEDIA/VIDEO/XP/switch -data I2:01
```

#### REST API Client in Mozilla

**Method:** POST  
**URL:** http://192.168.0.55/api/V1/MEDIA/VIDEO/XP/switch  
**Body content type:** text/plain  
**Body:** I2:01

#### 7.3.2. General Rules

- All names and parameters are case-insensitive.
- The methods, nodes and properties are separated by a slash (/) character.
- The node name consists of letters of the English alphabet and numbers.
- All properties and methods are available HTTP(S) below /api as an URL.
- The HTTP server is available on port 80, the HTTPS server is available on port 443.
- GET / PUT/ POST methods are supported.
- The request-line contains the IP address (or hostname) and the nodepath.
- Arguments and property values should be given in the HTTP request's body as a plain text.
- REST API - LW3 converter does escaping automatically.
- The node paths describe the exact location of the node, listing each parent node up to the root.
- The supported HTTP protocol: standard HTTP/1.1
- There is no maximum size or character length of the request.

#### 7.3.3. Legend for the Control Commands

##### Command and Response – Example

➔ request-line: GET-<ip>/api/V1/MEDIA/VIDEO/<in>/SignalPresent

← body: <status code>

Format	Description
<ip>	IP address or hostname of the target device
<in>	Input port number
<out>	Output port number
<port>	Input or output port number
<loc>	Location number
<parameter>	Variable defined and described in the command
<expression>	Batched parameters: the underline means that more expressions or parameters can be placed by using a semicolon, e.g. <u>I2;I4;I5</u> or <u>F27:E1;F47:E2</u>
➔	Sent request
←	Received response
.	Space character

Further, not listed <parameters> are defined at each command.

#### 7.3.4. Lightware REST API vs. LW3 Protocol

All methods and properties of the LW3 tree structure appear below /api as a HTTP(s) URL. The separator character is always a slash (/) character instead of point (.) and colon (:). The URL is case-insensitive.

##### Example

The LW3 property:  
 /V1/MEDIA/VIDEO/I2.ActiveResolution

Available in REST API:  
 192.168.0.1/api/V1/MEDIA/VIDEO/I1/ActiveResolution  
 192.168.0.1/API/v1/media/video/i1/activeresolution

The following features are implemented only in REST API, but not in LW3 protocol:

- Sending a message via RS-232

The most important commands are listed in this chapter. Other commands can be inferred by the LW3 tree structure, where the read-only (eg. **pr** /V1/MEDIA/VIDEO/I5.Connected) and read-write properties (**pw** /V1/MEDIA/VIDEO/I5.Name) can be listed. For more details about the LW3 tree structure, see the [LW3 Programmers' Reference](#) section or the [Advanced View Window](#).

### 7.3.5. Method Types

#### GET Method

GET method can be used to get the value of a property. It works the same way as the LW3 GET command.

#### PUT/ POST Method

In this case, POST and PUT are equivalent, they are for modifying read-write properties and invoking methods. They replace the LW3 SET and CALL commands.

### 7.3.6. Supported Commands

#### Querying property value (GET)

The requested value is in the body of the response.

Protocol	Command
REST API	→ request-line: GET<ip>/api/<NODEPATH>/<PropertyName>
Example	→ request-line: GET http://192.168.0.1/api/V1/MEDIA/VIDEO/XP/I2/SignalPresent
LW3	▶ GET·/<NODEPATH>.<PropertyName>
Example	▶ GET /V1/MEDIA/VIDEO/XP/I2.SignalPresent

#### Setting property value (SET)

The desired property value should be given as a plain text in the body of the request. The new value is in the body of the response.

Protocol	Command
REST API	→ request-line: POST<ip>/api/<NODEPATH>/<PropertyName> → body: <new_value>
Example	→ request-line: POST http://192.168.0.1/api/V1/MEDIA/VIDEO/XP/I2/Mute → body: false
LW3	▶ SET·/<NODEPATH>.<PropertyName>=<new_value>
Example	▶ SET /V1/MEDIA/VIDEO/XP/I2.Mute=false

#### Invoking method (CALL)

The argument should be given in the body of the request.

Protocol	Command
REST API	→ request-line: POST<ip>/api/<NODEPATH>/<methodName> → body: <new_value>
Example	→ request-line: POST http://192.168.0.1/api/V1/MEDIA/VIDEO/XP/switch → body: I5:01
LW3	▶ CALL·/<NODEPATH>:<methodName>(<value>)
Example	▶ CALL /V1/MEDIA/VIDEO/XP:switch(I5:01)

### 7.3.7. Not Supported Commands

#### Querying node (GET)

Protocol	Command	Note
REST API	Not supported	404 error code
LW3	▶ GET·/<NODEPATH>	
Example	▶ GET /V1/MEDIA/VIDEO	

#### Subscribing to a node (OPEN)

Protocol	Command	Note
REST API	Not interpreted	Not supported
LW3	▶ OPEN·/<NODEPATH>	
Example	▶ OPEN /V1/MEDIA/VIDEO	

#### Unsubscribing from a Node (CLOSE)

Protocol	Command	Note
REST API	Not interpreted	Not supported
LW3	▶ CLOSE·/<NODEPATH>	
Example	▶ CLOSE /V1/MEDIA/VIDEO	

### 7.3.8. Status Codes, Error Messages

The standard HTTP response codes are defined to supply information about the response and the executed command like:

Error code		Description
200	OK	Standard response for successful HTTP request.
401	Unauthorized	
405	Method Not Allowed	A request method is not supported for the requested resource. This is the error code when trying to modify a read-only property.
404	Not Found	Invalid nodepath or property name.
406	Not Acceptable	LW3 server error response for POST and PUT method, equals the following LW3 error codes: <b>pE</b> : an error for the property <b>mE</b> : an error for a method
500	Internal Server Error	All other errors (Lw3ErrorCodes_InternalError).

### 7.3.9. Polling

Subscription and unsubscription features are not supported, they can be substituted with polling. It means that a custom user script sends a request for a detected property from time to time.



## 7.4. REST API Security

The REST API is designed with two security features: **Authentication** and **Encryption**. Both of them are optional and can be used independently of each other.

### 7.4.1. Authentication

Basic access authentication is designed to limit user access for the REST API server. It requires user authentication by using a password (username is fixed).

Follow the instructions below to set the password:

**Step 1.** Set the password.

```
→ request-line: POST <ip>/api/V1/MANAGEMENT/NETWORK/AUTHENTICATION/setPassword
→ body: <new_password>
```

**Step 2.** Enable the basic authentication on the chosen port (HTTP: 80 or HTTPS: 443).

```
→ request-line: POST <ip>/api/V1/MANAGEMENT/NETWORK/SERVICES/HTTP/AuthenticationEnabled
→ body: true
```

**Step 3.** Restart network services.

```
→ request-line: POST <ip>/api/V1/MANAGEMENT/NETWORK/SERVICES/HTTP/restart
```

**ATTENTION!** The password will not be encrypted by this authentication mode, it remains accessible when the communication happens on HTTP.

For more details, see the [Basic Authentication](#) section.

### 7.4.2. Encryption (HTTPS)

There is no encryption when the REST API communication happens via HTTP, because the HTTP protocol is not encrypted. The REST API server is available via HTTPS on the 443 port. To avoid the data interception (e.g. stealing the password) HTTP should be disabled and HTTPS protocol should be used instead.

**ATTENTION!** Please ensure proper UCX time and date setting in UCX, because it affects the self-signed certificate (SSL) generation when using WSS or HTTPS. Improper time and date setting may lead to certificate rejection.

HTTPS does not guarantee that the communication is secure. Make sure that the client communicates with the server directly, without any third-party element in the communication route (Man-in-the-middle attack).

For more details, see the [Encryption \(HTTPS, WSS\)](#) section.

## 7.5. System Commands

### 7.5.1. Setting the Device Label

**INFO:** The device label can be changed to a custom text in the [TX Status](#) tab of the LDC software.

**Request and Response** #devicelabel #label

```
→ request-line: POST http://<ip>/api/V1/MANAGEMENT/LABEL/DeviceLabel
→ body: <custom_name>

← status-line: 200-OK
← body: <custom_name>
```

The Device Label can be 49 characters long and ASCII characters are allowed. Longer names are truncated.

**Example**

```
→ request-line: POST http://192.168.0.50/api/V1/MANAGEMENT/LABEL/DeviceLabel
→ body: UCXroom

← status-line: 200 OK
← body: UCXroom
```

### 7.5.2. Resetting the Device

The device can be restarted – the current connections will be terminated.

**Request and Response** #reboot #restart

```
→ request-line: POST http://<ip>/api/V1/SYS/DEVICES/<TX/RX>/restart
```

**INFO:** The body has to be empty, and the content type should be text/plain.

```
← status-line: 200 OK
```

**Example**

```
→ request-line: POST http://192.168.0.50/api/V1/SYS/DEVICES/TX/restart
← status-line: 200 OK
```

### 7.5.3. Restoring the Factory Default Settings

**Request and Response**

```
→ request-line: POST http://<ip>/api/V1/SYS/DEVICES/<TX/RX>/factoryDefaults
```

**INFO:** The body has to be empty, and the content type should be text/plain.

```
← status-line: 200 OK
```

**Example**

```
→ request-line: POST http://192.168.0.50/api/V1/SYS/DEVICES/TX/factoryDefaults
← status-line: 200 OK
```

The device is restarted, current connections are terminated, and the default settings are restored. See the complete list in the [Factory Default Settings](#) section. #factory

### 7.5.4. Querying the Firmware Package Version

#### Request and Response *#firmwareversion*

→ request-line: GET http://<ip>/api/V1/MANAGEMENT/UID/PACKAGE/Version  
 ← status-line: 200 OK  
 ← body: <firmware\_version>

#### Example

→ request-line: GET http://192.168.0.50/api/V1/MANAGEMENT/UID/PACKAGE/Version  
 ← status-line: 200 OK  
 ← body: 1.0.0b2

### 7.5.5. Control Lock

Enable/disable the operation of the front panel buttons.

#### Request and Response *#lockbutton #buttonlock*

→ request-line: POST http://<ip>/api/V1/MANAGEMENT/UI/ControlLock  
 → body: <lock\_status>  
 ← status-line: 200 OK  
 ← body: <lock\_status>

#### Parameters

Parameter	Parameter description	Values	Value description
<lock_status>	Front panel button locking status	<b>None</b>	<b>None:</b> all functions of the front panel button are enabled.
		<b>locked</b>	The front panel buttons are locked, and can be unlocked by a button combination ( <a href="#">Control Lock</a> ).
		<b>force locked</b>	The front panel buttons are locked and cannot be unlocked by a button combination, only in LDC (on the <a href="#">TX Status</a> tab) or using the LW3 command (or REST API).

#### Example

→ request-line: POST http://192.168.0.50/api/V1/MANAGEMENT/UI/ControlLock  
 → body: force locked  
 ← status-line: 200 OK  
 ← body: Force locked

### 7.5.6. Setting the Current Time

#### Request and Response *#time*

→ request-line: POST http://<ip>/api/V1/MANAGEMENT/DATETIME/setTime  
 → body: <current\_time>  
 ← status-line: 200 OK  
 ← body: OK

#### Parameters

<current\_time>: The new router time in ISO 8601 date time format.

#### Example

→ request-line: POST http://192.168.0.50/api/V1/MANAGEMENT/DATETIME/setTime  
 → body: 2034-05-06T14:47:25  
 ← status-line: 200 OK  
 ← body: OK

### 7.5.7. Identifying the Device

Calling the method makes the status LEDs blink for 10 seconds. The feature helps find the device physically.

#### Request and Response *#identifyme*

→ request-line: POST http://<ip>/api/V1/MANAGEMENT/UI/identifyMe  
 INFO: The body has to be empty, and the content type should be text/plain.  
 ← status-line: 200 OK

#### Example

→ request-line: POST http://192.168.0.50/api/V1/MANAGEMENT/UI/identifyMe  
 ← status-line: 200 OK

### 7.5.8. Toggling the Dark Mode Setting

The LEDs of the device can be switched off if their light could be annoying. In Dark mode all the LEDs are switched off, except the LEDs of the RJ45 connectors (Ethernet and TPX in/out). *#darkmode*

#### Request and Response

→ request-line: POST http://<ip>/api/V1/MANAGEMENT/UI/DARKMODE/Enable  
 → body: <mode\_state>  
 ← status-line: 200 OK  
 ← body: <mode\_state>

#### Parameters

If the <mode\_state> parameter is **true** (or **1**), the Dark mode function is **enabled**, if the parameter is **false** (or **0**), the function is **disabled**.

**Example**

```

→ request-line: POST http://192.168.0.50/api/V1/MANAGEMENT/UI/DARKMODE/Enable
→ body:         true
← status-line:  200 OK
← body:         true

```

**7.5.9. Setting the Delay of the Dark Mode**

The Dark mode can be enabled right away, or after a certain time. Thus, the mode is enabled if no buttons are pressed for a while. Pressing any button brings back the status info on the LEDs without performing the function of the button itself. The delay time can be set with this command.

**Request and Response**

```

→ request-line: POST http://<ip>/api/V1/MANAGEMENT/UI/DARKMODE/Delay
→ body:         <delay_time>
← status-line:  200 OK
← body:         <delay_time>

```

**Parameters**

The <delay\_time> parameter means seconds, and the default value is 0. If set to 0, no delay is applied, and the Dark mode can be enabled immediately by the **DarkModeEnable** property. This delay has an affect to the **wakeFromDarkMode** method as well.

**Example**

```

→ request-line: POST http://192.168.0.50/api/V1/MANAGEMENT/UI/DARKMODE/Delay
→ body:         10
← status-line:  200 OK
← body:         10

```

**7.6. Video Port Settings - General****7.6.1. Switching the Video Input****Request and Response**

```

→ request-line: POST http://<ip>/api/V1/MEDIA/VIDEO/XP/switch
→ body:         <in>:<out>
← status-line:  200 OK

```

**Example**

```

→ request-line: POST http://192.168.0.50/api/V1/MEDIA/VIDEO/XP/switch
→ body:         I5:O1
← status-line:  200 OK

```

INFO: When using the '0' value as an input, the input will be disconnected and no signal will appear on the output.

**ATTENTION!** Video crosspoint has a limitation: I1 and I5 ports are not available at the same time, only one of them can be selected to any output. When one of the outputs is switched to I1 or I5, the other output can not be switched to I1 or I5. In this case the switch command returns an error message.

**Example**

```

→ request-line: GET http://192.168.0.50/api/V1/MEDIA/VIDEO/XP/O1/ConnectedSource
← body:         I5
→ request-line: GET http://192.168.0.50/api/V1/MEDIA/VIDEO/XP/O2/ConnectedSource
← body:         I5
→ request-line: POST http://192.168.0.50/api/V1/MEDIA/VIDEO/XP/switch
→ body:         I1:O1
← header:       405 Method Not Allowed

```

**7.6.2. Switching an Input to All Outputs****Request and Response**

```

→ request-line: POST http://<ip>/api/V1/MEDIA/VIDEO/XP/switchAll
→ body:         <in>
← status-line:  200 OK

```

**Example**

```

→ request-line: POST http://192.168.0.50/api/V1/MEDIA/VIDEO/XP/switchAll
→ body:         I1
← status-line:  200 OK

```

### 7.6.3. Locking the Video Port

#### Request and Response

→ request-line: POST-http://<ip>/api/V1/MEDIA/VIDEO/XP/<port>/Lock  
 → body: <locked\_state>  
 ← status-line: 200 OK  
 ← body: <locked\_state>

#### Parameters

Parameter	Parameter description	Values	Value description
<locked_state>	Locked state	true	The port is locked
		false	The port is unlocked

#### Example

→ request-line: POST http://192.168.0.50/api/V1/MEDIA/VIDEO/XP/I2/Lock  
 → body: false  
 ← status-line: 200 OK  
 ← body: false

### 7.6.4. Muting the Video Port

#### Request and Response

→ request-line: POST-http://<ip>/api/V1/MEDIA/VIDEO/XP/<port>/Mute  
 → body: <muted\_state>  
 ← status-line: 200 OK  
 ← body: <muted\_state>

#### Parameters

Parameter	Parameter description	Values	Value description
<muted_state>	Muted state	true	The port is locked.
		false	The port is unlocked.

#### Example

→ request-line: POST http://192.168.0.50/api/V1/MEDIA/VIDEO/XP/I2/Mute  
 → body: false  
 ← status-line: 200 OK  
 ← body: false

### 7.6.5. Setting the Autoselect Policy

#### Request and Response

→ request-line: POST-http://<ip>/api/V1/MEDIA/VIDEO/AUTOSELECT/<out>/Policy  
 → body: <autoselect\_mode>  
 ← status-line: 200 OK  
 ← body: <autoselect\_mode>

#### Parameters

Parameter	Parameter description	Values	Value description
<autoselect_mode>	The autoselect policy	Off	The autoselect function is disabled.
		Last Detect	It is always the last attached input that is automatically switched to the output.
		First Detect	The first active video input is selected.

#### Example

→ request-line: POST http://192.168.0.50/api/V1/MEDIA/VIDEO/AUTOSELECT/O2/Policy  
 → body: First detect  
 ← status-line: 200 OK  
 ← body: First detect

### 7.6.6. Changing the Autoselect-Included Input Ports

#### Request and Response

→ request-line: POST-http://<ip>/api/V1/MEDIA/VIDEO/AUTOSELECT/<out>/<in>/Included  
 → body: <state>  
 ← status-line: 200 OK  
 ← body: <state>

#### Parameters

Parameter	Parameter description	Values	Value description
<state>	The chosen input is ignored in the autoselect process or not.	true	The port is included in autoselect.
		false	The autoselect function ignores that port.

#### Example

→ request-line: POST http://192.168.0.50/api/V1/MEDIA/VIDEO/AUTOSELECT/O2/I1/Included  
 → body: false  
 ← status-line: 200 OK  
 ← body: false

### 7.6.7. Changing the Input Port Priority

#### Request and Response

```
→ request-line: POST http://<ip>/api/V1/MEDIA/VIDEO/AUTOSELECT/<out>/<in>/Priority
→ body:         <prio_num>

← status-line:  200 OK
← body:         <prio_num>
```

#### Parameters

The <prio> parameter means the priority number from 1 to 100, equal numbers are allowed. Inputs can have different priorities in relation with two or more outputs. Therefore the output port number is part of the node path of input port priorities.

#### Example

```
→ request-line: POST http://192.168.0.50/api/V1/MEDIA/VIDEO/AUTOSELECT/O2/I2/Priority
→ body:         51

← status-line:  200 OK
← body:         51
```

### 7.6.8. Querying the Connected Source

#### Request and Response

```
→ request-line: GET http://<ip>/api/V1/MEDIA/VIDEO/XP/<out>/ConnectedSource
← status-line:  200 OK
← body:         <in>
```

#### Example

```
→ request-line: GET http://192.168.0.50/api/V1/MEDIA/VIDEO/XP/O2/ConnectedSource
← status-line:  200 OK
← body:         I1
```

### 7.6.9. Querying the Connected Destinations

#### Request and Response

```
→ request-line: GET http://<ip>/api/V1/MEDIA/VIDEO/XP/<in>/ConnectedDestinations
← status-line:  200 OK
← body:         [<out1>,<out1>"]
```

#### Example

```
→ request-line: GET http://192.168.0.50/api/V1/MEDIA/VIDEO/XP/I3/ConnectedDestinations
← status-line:  200 OK
← body:         ["O1","O2"]
```

### 7.6.10. Querying the Input Switching Capability

Video crosspoint has a limitation: I1 or I5 ports can not be selected to any output at the same time. **Busy** value of the switchable property refers to the limitation.

#### Request and Response

```
→ request-line: GET http://<ip>/api/V1/MEDIA/VIDEO/XP/<out>/SWITCHABLE/<in>
← status-line:  200 OK
← body:         <switchable_state>
```

#### Parameters

Parameter	Parameter description	Values	Value description
<switchable_state>	The chosen input is can be switched to the output or not.	OK	The connection of the chosen input and output is allowed.
		Busy	The chosen input can not be switched to the output.
		Locked	The chosen input can not be switched to the output, because the input is locked.

#### Example

```
→ request-line: GET http://192.168.0.50/api/V1/MEDIA/VIDEO/XP/O2/SWITCHABLE/I1
← status-line:  200 OK
← body:         Busy
```

### 7.6.11. Query the Video Signal Presence

#### Request and Response

```
→ request-line: GET http://<ip>/api/V1/MEDIA/VIDEO/<port>/SignalPresent
← status-line:  200 OK
← body:         <state>
```

#### Parameters

Parameter	Parameter description	Values	Value description
<state>	This property gives a feedback about the current signal presence of the port.	true	The video signal is present.
		false	The video signal is not present.

#### Example

```
→ request-line: GET http://192.168.0.50/api/V1/MEDIA/VIDEO/I1/SignalPresent
← status-line:  200 OK
← body:         true
```

### 7.6.12. HDCP Setting (Input Port)

HDCP capability can be set on the input ports, thus non-encrypted content can be seen on a non-HDCP compliant display. See more information in the [HDCP Management](#) section.

**ATTENTION!** HDCP 2.2 signal handling is limited to up to two input ports at the same time.

#### Request and Response *#hdcp*

→ request-line: POST http://<ip>/api/V1/MEDIA/VIDEO/<in>/HDCP/AllowedHdcpVersion  
 → body: <allowed\_hdcp>  
 ← status-line: 200 OK  
 ← body: <allowed\_hdcp>

#### Parameters

Parameter	Parameter description	Values	Value description
<allowed_hdcp>	The input port reports the HDCP capability.	<b>HDCP 1.4</b> <b>HDCP 2.2</b> <b>Off</b>	The input port reports HDCP 1.4 capability. The input port reports HDCP 2.2 capability. The input port reports non-HDCP compliance.

#### Example

→ request-line: POST http://192.168.0.50/api/V1/MEDIA/VIDEO/I1/HDCP/AllowedHdcpVersion  
 → body: HDCP 1.4  
 ← status-line: 200 OK  
 ← body: HDCP 1.4

### 7.6.13. HdcpMode

HDCP capability can be set to Auto/Always on the output ports, thus non-encrypted content can be transmitted to a non-HDCP compliant display. See more information in the [HDCP Management](#) section.

#### Request and Response *#hdcp*

→ request-line: POST http://<ip>/api/V1/MEDIA/VIDEO/<out>/HdcpMode  
 → body: <hdcp\_mode>  
 ← status-line: 200 OK  
 ← body: <hdcp\_mode>

#### Parameters

Parameter	Parameter description	Values	Value description
<hdcp_mode>	HDCP encryption setting on the output port	<b>Auto</b> <b>Always</b>	The encryption is enabled on the output port if the signal on the input port is encrypted. The outgoing signal is HDCP-encrypted.

#### Example

→ request-line: POST http://192.168.0.50/api/V1/MEDIA/VIDEO/O1/HDCP/HdcpMode  
 → body: Auto  
 ← status-line: 200 OK  
 ← body: Auto

### 7.6.14. Querying the Embedded Audio Presence

→ request-line: GET http://<ip>/api/V1/MEDIA/VIDEO/<port>/EmbeddedAudioPresent  
 ← status-line: 200 OK  
 ← body: <embedded\_state>

#### Parameters

Parameter	Parameter description	Values	Value description
<embedded_state>	It shows if the video contains audio or not.	<b>true</b>	There is embedded audio in the video signal.
		<b>false</b>	There is no embedded audio in the video signal.

#### Example

→ request-line: GET http://192.168.0.50/api/V1/MEDIA/VIDEO/I2/EmbeddedAudioPresent  
 ← status-line: 200 OK  
 ← body: true

### 7.6.15. Muting the Embedded Audio

→ request-line: POST http://<ip>/api/V1/MEDIA/VIDEO/<port>/EmbeddedAudioMute  
 → body: <mute\_state>  
 ← status-line: 200 OK  
 ← body: <mute\_state>

#### Parameters

Parameter	Parameter description	Values	Value description
<mute_state>	It shows if the embedded audio is muted or not.	<b>true</b>	The embedded audio is muted.
		<b>false</b>	The embedded audio is unmuted.

#### Example

→ request-line: POST http://192.168.0.50/api/V1/MEDIA/VIDEO/O1/EmbeddedAudioMute  
 → body: false  
 ← status-line: 200 OK  
 ← body: false

### 7.6.16. Setting the Output Signal Type

#### Request and Response *#signaltype*

→ request-line: POST http://<ip>/api/V1/MEDIA/VIDEO/<out>/OutputSignalType  
 → body: <signal\_type>  
 ← status-line: 200 OK  
 ← body: <signal\_type>

#### Parameters

Parameter	Parameter description	Values	Value description
<signal_type>	Signal type setting	Auto	The outgoing signal type is HDMI.
		DVI	The outgoing signal type is DVI.

#### Example

→ request-line: POST http://192.168.0.50/api/V1/MEDIA/VIDEO/01/OutputSignalType  
 → body: Auto  
 ← status-line: 200 OK  
 ← body: Auto

### 7.6.17. Turning on Output 5V

The 5V power towards the sink can be enabled or disabled as follows:

#### Request and Response

→ request-line: POST http://<ip>/api/V1/MEDIA/VIDEO/<out>/Output5VMode  
 → body: <5V\_pwr>  
 ← status-line: 200 OK  
 ← body: <5V\_pwr>

#### Parameters

Parameter	Parameter description	Value	Value description
<5V_pwr>	5V power towards the sink	On	Enable 5V power on HDMI port
		Off	Disable 5V power on HDMI port

#### Example

→ request-line: POST http://192.168.0.50/api/V1/MEDIA/VIDEO/01/Output5VMode  
 → body: On  
 ← status-line: 200 OK  
 ← body: On

### 7.7. Welcome Screen Settings

**DIFFERENCE:** These commands are not available for HDMI-UCX-TPX-RX107.

For details about the Welcome screen feature, please see the [Welcome Screen](#) section.

#### 7.7.1. Displaying the Welcome Screen Image

##### Request and Response *#welcomescreen*

→ request-line: POST http://<ip>/api/V1/MEDIA/VIDEO/I5/WELCOMESCREEN/ImageEnabled  
 → body: <image\_state>  
 ← status: 200 OK  
 ← body: <image\_state>

##### Parameters

Parameter	Values	Value description
<image_state>	true	The welcome screen image is displayed.
	false	The welcome screen image is not displayed.

##### Example

→ request-line: POST http://192.168.0.50/api/V1/MEDIA/VIDEO/I5/WELCOMESCREEN/ImageEnabled  
 → body: true  
 ← status-line: 200 OK  
 ← body: true

#### 7.7.2. Displaying the Welcome Screen Text

##### Request and Response

→ request-line: POST http://<ip>/api/V1/MEDIA/VIDEO/I5/WELCOMESCREEN/MessageEnabled  
 → body: <text\_state>  
 ← status-line: 200 OK  
 ← body: <text\_state>

##### Parameters

Parameter	Values	Value description
<text_state>	true	The welcome screen text is displayed.
	false	The welcome screen text is not displayed.

##### Example

→ request-line: POST http://192.168.0.50/api/V1/MEDIA/VIDEO/I5/WELCOMESCREEN/MessageEnabled  
 → body: false  
 ← status-line: 200 OK  
 ← body: false

### 7.7.3. Setting the Welcome Screen Text

#### Request and Response

→ request-line: POST http://<ip>/api/V1/MEDIA/VIDEO/I5/WELCOMESCREEN/MessageText  
 → body: <text>  
 ← status-line: 200 OK  
 ← body: <text>

#### Parameters

The <text> may consist of letters (A-Z) and (a-z), hyphen (-), underscore (\_), numbers (0-9), space ( ) and dot (.). Max length: 63 characters. Longer names are truncated.

#### Example

→ request-line: POST http://192.168.0.50/api/V1/MEDIA/VIDEO/I5/WELCOMESCREEN/MessageText  
 → body: helloworld  
 ← status-line: 200 OK  
 ← body: helloworld

### 7.7.4. Resetting the Welcome Screen Image

This command restores the original welcome screen image.

#### Request and Response

→ request-line: POST http://<ip>/api/V1/MEDIA/VIDEO/I5/WELCOMESCREEN/resetImage  
 INFO: The body has to be empty, and the content type should be text/plain.  
 ← status-line: 200 OK

#### Example

→ request-line: POST http://192.168.0.50/api/V1/MEDIA/VIDEO/I5/WELCOMESCREEN/resetImage  
 ← status-line: 200 OK

## 7.8. Video Port Settings - USB-C Related Commands

**DIFFERENCE:** UCX-3x3-TPX-RX20 does not have a USB-C port.

### 7.8.1. Restarting the Link Training

This method is equal to pulling the USB-C connector out and plugging it in again.

#### Request and Response

#linktraining

→ request-line: POST http://<ip>/api/V1/MEDIA/VIDEO/<in>/DP/restartLinkTraining  
 INFO: The body has to be empty, and the content type should be text/plain.  
 ← status-line: 200 OK

#### Example

→ request-line: POST http://192.168.0.50/api/V1/MEDIA/VIDEO/I1/DP/restartLinkTraining  
 ← status-line: 200 OK

## 7.9. CEC Command Sending

The device is able to send Consumer Electronics Control (CEC) commands. This feature is for remote controlling the source or sink device. CEC is a bi-directional communication via the HDMI cable.

**ATTENTION!** To have a successful CEC command processing, the connected HDMI device must support CEC. #cec

### 7.9.1. Simple CEC Code Sending

This command is for sending simple CEC commands to the connected sink device. In this case the <command> is sent in a CEC frame without any opcode. The command also allows sending many commands at once.

The commands can be sent by the following two formats – defined in the header:

- **text/plain:** hexa strings (as seen in the example)
- **application/octet-stream:** binary data that allows sending a file with the desired codes

#### Request and Response

→ request-line: POST http://<ip>/api/V1/MEDIA/VIDEO/<port>/CEC/send  
 → body: <command>  
 ← status-line: 200 OK  
 ← body: <response>

#### Parameters

Parameter	Parameter description	Values	Value description
<port>	Video output port	01-02-03	Video output port number
<command> *	Two-digit-long hexa code to control the sink device	04	Power on
		0D	Power off
		36	Standby
		821000	Select input 1
		822000	Select input 2
		823000	Select input 3

\* The supported list of <commands> depends on the connected sink device.

The <response> can be:

<response>	HTTP code	Result
ACK	200	The transmission is successful
NACK	444	The command is not accepted
Timeout	408	Timeout
Internal Error	500	Other error



**Example**

```

→ request-line: POST http://192.168.1.9/api/V1/MEDIA/VIDEO/01/CEC/send
→ body:        04
← status-line: 200 OK
← body:        ACK

```

**7.9.2. Remote Control Code Sending**

This command is for sending the so-called 'push-button-commands'. There is a range within the CEC commands for this purpose, e.g. volume up/down. With this method one `<command>` is put between the 0x44 and 0x45 opcodes in the background.

**Request and Response**

```

→ request-line: POST http://<ip>/api/V1/MEDIA/VIDEO/<port>/CEC/sendUserControlClick
→ body:        <command>
← status-line: 200 OK
← body:        <response>

```

**Parameters**

Parameter	Parameter description	Values	Value description
<code>&lt;port&gt;</code>	Video output port	01-02-03	Video output port number
<code>&lt;command&gt; *</code>	Two-digit-long hexa code to control the sink device	6D 6C	Power on Power off

\* The supported list of `<commands>` depends on the connected sink device.

The `<response>` can be the same as written at the previous command.

**Example**

```

→ request-line: POST http://192.168.1.9/api/V1/MEDIA/VIDEO/01/CEC/sendUserControlClick
→ body:        6D
← status-line: 200 OK
← body:        ACK

```

**7.10. Audio Port Settings**

INFO: Audio port numbers may differ depending on the model. For more information, see the [Port Numbering](#) section.

**7.10.1. Switching the Audio Input****Request and Response**

```

→ request-line: POST http://<ip>/api/V1/MEDIA/AUDIO/XP/switch
→ body:        <audio_in>:03
← status-line: 200 OK
← body:        <audio_in>:03

```

**Parameters**

Parameter	Parameter description	Values	Value description
<code>&lt;audio_in&gt;</code>	Audio input port	I1-I4	Audio input port number

**Example**

```

→ request-line: POST http://192.168.0.50/api/V1/MEDIA/AUDIO/XP/switch
→ body:        I2:03
← status-line: 200 OK
← body:        I2:03

```

INFO: When using the '0' value as an input, the input will be disconnected and no signal will appear on the output.

**ATTENTION!** When I5 is selected for video source, the de-embedded audio of the I1 is not available, because the video crosspoint has a limitation: I1 and I5 ports are not available at the same time, only one of them can be selected to any output. For more details about it, see the port diagram in the [Audio Interface](#) section.

**7.10.2. Querying the Connected Source****Request and Response**

```

→ request-line: GET http://<ip>/api/V1/MEDIA/AUDIO/XP/03/ConnectedSource
← status-line: 200 OK
← body:        <audio_in>

```

**Parameters**

Parameter	Parameter description	Values	Value description
<code>&lt;audio_in&gt;</code>	Audio input port	I1-I4	Audio input port number

**Example**

```

→ request-line: GET http://192.168.0.50/api/V1/MEDIA/AUDIO/XP/03/ConnectedSource
← status-line: 200 OK
← body:        I2

```

### 7.10.3. Querying the Connected Destinations

#### Request and Response

→ request-line: GET http://<ip>/api/V1/MEDIA/AUDIO/XP/<audio\_in>/ConnectedDestinations  
 ← status-line: 200 OK  
 ← body: <audio\_out>

#### Parameters

Parameter	Parameter description	Values	Value description
<audio_in>	Audio input port	I1-I4	Audio input port number
<audio_out>	Audio output port	O4	Audio output port number

#### Example

→ request-line: GET http://192.168.0.50/api/V1/MEDIA/AUDIO/XP/I3/ConnectedDestinations HTTP/1.1  
 ← status-line: 200 OK  
 ← body: O4

### 7.10.4. Setting the Autoselect Operation Mode

#### Request and Response

→ request-line: POST http://<ip>/api/V1/MEDIA/AUDIO/AUTOSELECT/<audio\_out>/Policy  
 → body: <op\_mode>  
 ← status-line: 200 OK  
 ← body: <op\_mode>

#### Parameters

Parameter	Parameter description	Values	Value description
<op_mode>	Operation mode	Follow video	Follows the video crosspoint state automatically.
		Off	Autoselect function is disabled.

#### Example

→ request-line: POST http://192.168.0.50/api/V1/MEDIA/AUDIO/AUTOSELECT/O3/Policy  
 → body: Follow video  
 ← status-line: 200 OK  
 ← body: Follow video

### 7.10.5. Setting the Followed Video Port to Autoselect

#### Request and Response

→ request-line: POST http://<ip>/api/V1/MEDIA/AUDIO/AUTOSELECT/O3/VideoFollowPort  
 → body: <out>  
 ← status-line: 200 OK  
 ← body: <out>

#### Example

→ request-line: POST http://192.168.0.50/api/V1/MEDIA/AUDIO/AUTOSELECT/O3/VideoFollowPort  
 → body: O1  
 ← status-line: 200 OK  
 ← body: O1

### 7.10.6. Locking the Audio Port

#### Request and Response

→ request-line: POST http://<ip>/api/V1/MEDIA/AUDIO/XP/<audio\_port>/Lock  
 → body: <locked\_state>  
 ← status-line: 200 OK  
 ← body: <locked\_state>

#### Parameters

Parameter	Parameter description	Values	Value description
<audio_port>	Audio port	I1-I4	Audio input port number
		O4	Audio output port number
<locked_state>	Locked state	true	The port is locked
		false	The port is unlocked

#### Example

→ request-line: POST http://192.168.0.50/api/V1/MEDIA/AUDIO/XP/I2/Lock  
 → body: false  
 ← status-line: 200 OK  
 ← body: false

### 7.10.7. Muting the Audio Port 1.

INFO: Suspends the connection of the chosen port (no signal is forwarded).

#### Request and Response

→ request-line: POST http://<ip>/api/V1/MEDIA/AUDIO/XP/<audio\_port>/Mute  
 → body: <muted\_state>  
 ← status-line: 200 OK  
 ← body: <muted\_state>

#### Parameters

Parameter	Parameter description	Values	Value description
<audio_port>	Audio port	I1-I4 O4	Audio input port number Audio output port number
<muted_state>	Muted state	true false	The port is muted. The port is unmuted.

#### Example

→ request-line: POST http://192.168.0.50/api/V1/MEDIA/AUDIO/XP/I2/Mute  
 → body: false  
 ← status-line: 200 OK  
 ← body: false

INFO: All inputs and analog output ports have a mute property in the audio XP (e.g. http://<ip>/api/V1/MEDIA/AUDIO/XP/I1.Mute). Outputs have a separate mute function within the port node as well:

- http://<ip>/api/V1/MEDIA/VIDEO/XP/O1.EmbeddedAudioMute
- http://<ip>/api/V1/MEDIA/VIDEO/XP/O2.EmbeddedAudioMute
- http://<ip>/api/V1/MEDIA/AUDIO/O3.Mute

### 7.10.8. Muting the Audio Port 2.

INFO: The volume of the analog audio output is set to low.

#### Request and Response

→ request-line: POST http://<ip>/api/V1/MEDIA/AUDIO/<audio\_port>/Mute  
 → body: <muted\_state>  
 ← status-line: 200 OK  
 ← body: <muted\_state>

#### Parameters

Parameter	Parameter description	Values	Value description
<audio_port>	Audio port	I1-I4 O4	Audio input port number Audio output port number
<muted_state>	Muted state	true false	The port is muted. The port is unmuted.

#### Example

→ request-line: POST http://192.168.0.50/api/V1/MEDIA/AUDIO/O4/Mute  
 → body: false  
 ← status-line: 200 OK  
 ← body: false

### 7.10.9. Querying the Audio Signal Presence

#### Request and Response

→ request-line: GET http://<ip>/api/V1/MEDIA/AUDIO/<audio\_port>/SignalPresent  
 ← status-line: 200-OK  
 ← body: <signal\_state>

#### Parameters

Parameter	Parameter description	Values	Value description
<audio_port>	Audio port	I1-I4 O4	Audio input port number Audio output port number
<signal_state>	Signal presence	true false	The audio signal is present. No audio signal is present.

#### Example

→ request-line: GET http://192.168.0.50/api/V1/MEDIA/AUDIO/I1/SignalPresent  
 ← status-line: 200 OK  
 ← body: false

### 7.10.10. Analog Audio Output Volume (dB) Setting

#### Request and Response *#analogaudio #volume*

→ request-line: POST http://<ip>/api/V1/MEDIA/AUDIO/<audio\_port>/VolumedB  
 → body: <level>  
 ← status-line: 200 OK  
 ← body: <level>

#### Parameter

The <level> parameter sets the output volume (attenuation) between -95.62 dB and 0 dB in step of -0.375 dB. The value is rounded up if necessary, to match with the step value.

#### Example

→ request-line: POST http://192.168.0.50/api/V1/MEDIA/AUDIO/O4/VolumedB  
 → body: -15  
 ← status-line: 200 OK  
 ← body: -15

### 7.10.11. Analog Audio Output Volume Percent Setting

#### Request and Response

→ request-line: POST http://<ip>/api/V1/MEDIA/AUDIO/<audio\_port>/VolumePercent  
 → body: <percent>  
 ← status-line: 200 OK  
 ← body: <percent>

#### Parameters

The <percent> parameter sets the output volume (attenuation) between 100% and 0%, in step of 1%. The value is rounded up if necessary, to match with the step value.

#### Example

→ request-line: POST http://192.168.0.50/api/V1/MEDIA/AUDIO/O4/VolumePercent  
 → body: 50  
 ← status-line: 200 OK  
 ← body: 50

### 7.10.12. Setting the Balance

#### Request and Response *#balance*

→ request-line: POST http://<ip>/api/V1/MEDIA/AUDIO/<audio\_port>/Balance  
 → body: <level>  
 ← status-line: 200 OK  
 ← body: <level>

#### Parameters

The <level> parameter sets the balance; -100 means left balance, 100 means right balance, step is 1. Center is 0 (default).

#### Example

→ request-line: POST http://192.168.0.50/api/V1/MEDIA/AUDIO/O4/Balance  
 → body: 0  
 ← status-line: 200 OK  
 ← body: 0

### 7.10.13. Analog Audio Output Level Setting by Steps (dB)

#### Request and Response *#analogaudio #volume*

→ request-line: POST http://<ip>/api/V1/MEDIA/AUDIO/<audio\_port>/stepVolumedB  
 → body: <step>  
 ← status-line: 200 OK  
 ← body: <step>

#### Parameters

The volume is increased or decreased with the given <step> value in dB.

#### Example

→ request-line: POST http://192.168.0.50/api/V1/MEDIA/AUDIO/O4/stepVolumedB  
 → body: -1  
 ← status-line: 200 OK  
 ← body: OK

The volume is decreased with 1 dB, the current volume is -1.95 dB, which means 77.84% in percent.

### 7.10.14. Analog Audio Output Level Setting by Steps in Percent

#### Request and Response

→ request-line: POST http://<ip>/api/V1/MEDIA/AUDIO/<audio\_port>/stepVolumePercent  
 → body: <step>  
 ← status-line: 200 OK  
 ← body: <step>

#### Parameters

The volume is increased or decreased by the given <step> value in percent.

#### Example

→ request-line: POST http://192.168.0.50/api/V1/MEDIA/AUDIO/O4/stepVolumePercent  
 → body: 5  
 ← status-line: 200 OK  
 ← body: OK

### 7.10.15. Analog Audio Output Balance Setting by Steps

#### Request and Response

→ request-line: POST http://<ip>/api/V1/MEDIA/AUDIO/<audio\_port>/stepBalance  
 → body: <step>  
 ← status-line: 200 OK  
 ← body: <step>

#### Parameters

The volume is increased or decreased by the given <step> value.

#### Example

→ request-line: POST http://192.168.0.50/api/V1/MEDIA/AUDIO/O4/stepBalance  
 → body: 5  
 ← status-line: 200 OK  
 ← body: OK

### 7.11. USB Port Settings

INFO: USB port numbers may differ depending on the model. For more information, see the [Port Numbering](#) section.

#### 7.11.1. Switching the USB Input

##### Request and Response #usb

→ request-line: POST http://<ip>/api/V1/MEDIA/USB/XP/switch<host>/H1  
 → body: <host>:H1  
 ← status-line: 200 OK  
 ← body: <host>:H1

##### Parameters

Parameter	Parameter description	Values	Value description
<host>	USB Host	0 U1-U4	Disconnected USB-C and USB-B port number

##### Example

→ request-line: POST http://192.168.0.50/api/V1/MEDIA/USB/XP/switch  
 → body: U1:H1  
 ← status-line: 200 OK  
 ← body: OK

INFO: When using the '0' value as an input, the input will be disconnected and no signal will appear on the output.

#### 7.11.2. Querying the Connected Source

##### Request and Response

→ request-line: GET http://<ip>/api/V1/MEDIA/USB/XP/H1/ConnectedSource  
 ← status-line: 200 OK  
 ← body: <host>

##### Parameters

Parameter	Parameter description	Values	Value description
<host>	USB Host	U1-U4	USB-C and USB-B port number

##### Example

→ request-line: GET http://192.168.0.50/api/V1/MEDIA/USB/XP/H1/ConnectedSource  
 ← status-line: 200 OK  
 ← body: U4

### 7.11.3. Querying the Connected Destinations

#### Request and Response *#autoselect*

→ request-line: GET http://<ip>/api/V1/MEDIA/USB/XP/<host>/ConnectedDestinations  
 ← status-line: 200 OK  
 ← body: <host>

#### Parameters

Parameter	Parameter description	Values	Value description
<host>	USB Host	U1-U4	USB-C and USB-B port number

#### Example

→ request-line: GET http://192.168.0.50/api/V1/MEDIA/USB/XP/U3/ConnectedDestinations  
 ← status-line: 200 OK  
 ← body: H1

### 7.11.4. Locking the USB Port

#### Request and Response *#lock*

→ request-line: POST http://<ip>/api/V1/MEDIA/USB/XP/<usb\_port>/Lock  
 → body: <locked\_state>  
 ← status-line: 200 OK  
 ← body: <locked\_state>

#### Parameters

Parameter	Parameter description	Values	Value description
<usb_port>	USB Port	U1-U4 H1	USB-C and USB-B port number USB hub
<locked_state>	Locked state	true false	The port is locked The port is unlocked

#### Example

→ request-line: POST http://192.168.0.50/api/V1/MEDIA/USB/XP/U2/Lock  
 → body: false  
 ← status-line: 200 OK  
 ← body: false

### 7.11.5. Setting the 5V Sending to the USB Peripherals

The 5V power towards the USB A-type ports can be enabled or disabled as follows:

#### Request and Response

→ request-line: POST http://<ip>/api/V1/MEDIA/USB/H1/<device\_id>/Power5VMode  
 → body: <device\_pwr>  
 ← status-line: 200 OK  
 ← body: <device\_pwr>

#### Parameters

Parameter	Parameter description	Values	Value description
<device_id>	USB A-type port	D1-D4	Downstream port number
<device_pwr>	5V power sending	Auto	The host controls the 5V power sending.
		Off	Disable 5V power on USB downstream port

#### Example

→ request-line: POST http://192.168.0.50/api/V1/MEDIA/USB/H1/D1/Power5VMode  
 → body: Auto  
 ← status-line: 200 OK  
 ← body: Auto

### 7.11.6. Setting the USB Autoselect Policy

#### Request and Response

→ request-line: POST http://<ip>/api/V1/MEDIA/USB/AUTOSELECT/H1/Policy  
 → body: <op\_mode>  
 ← status-line: 200 OK  
 ← body: <op\_mode>

#### Parameters

Parameter	Parameter description	Values	Value description
<op_mode>	Operation mode	Off	The autoselect function is disabled.
		Last Detect	It is always the last attached input that is automatically switched to the output.
		First Detect	The first active USB input is selected.
		Follow video	Follows the video crosspoint state automatically.

**Example**

```
→ request-line: POST http://192.168.0.50/api/V1/MEDIA/USB/AUTOSELECT/H1/Policy
→ body: Follow video
← status-line: 200 OK
← body: Follow video
```

**7.11.7. Setting the Followed Video Port to Autoselect**

**Request and Response**

```
→ request-line: POST http://<ip>/api/V1/MEDIA/USB/AUTOSELECT/H1/VideoFollowPort
→ body: <out>
← status-line: 200 OK
← body: <out>
```

**Example**

```
→ request-line: POST http://192.168.0.50/api/V1/MEDIA/USB/AUTOSELECT/H1/VideoFollowPort
→ body: 01
← status-line: 200 OK
← body: 01
```

**7.11.8. Changing the Autoselect Included USB Ports**

**Request and Response**

```
→ request-line: POST http://<ip>/api/V1/MEDIA/USB/AUTOSELECT/H1/<host>/Included
→ body: <state>
← status-line: 200 OK
← body: <state>
```

**Parameters**

Parameter	Parameter description	Values	Value description
<host>	USB Host	U1-U4	USB-C and USB-B port number
<state>	The chosen input is ignored from the autoselect process or not.	true	The port is included in autoselect.
		false	The autoselect function ignores that port.

**Example**

```
→ request-line: POST http://192.168.0.50/api/V1/MEDIA/USB/AUTOSELECT/H1/U1/Included
→ body: false
← status-line: 200 OK
← body: false
```

**7.11.9. Changing the USB Port Priority**

**Request and Response**

```
→ request-line: POST http://<ip>/api/V1/MEDIA/USB/AUTOSELECT/H1/<host>/Priority
→ body: <prio_num>
← status-line: 200 OK
← body: <prio_num>
```

**Parameters**

Parameter	Parameter description	Values	Value description
<host>	USB Host	U1-U4	USB-C and USB-B port number
<prio_num>	Priority number from 1 to 100, equal numbers are allowed.	1-100	1: the highest priority 100: the lowest priority

**Example**

```
→ request-line: POST http://192.168.0.50/api/V1/MEDIA/USB/AUTOSELECT/H1/U1/Priority
→ body: 51
← status-line: 200 OK
← body: 51
```

**7.12. USB Port Settings - USB-C Related Commands**

INFO: USB-C port numbers may differ depending on the model. For more information, see the [Port Numbering](#) section.

**DIFFERENCE:** UCX-3x3-TPX-RX20 and HDMI-UCX-TPX-RX107 models do not have USB-C ports.

**7.12.1. Setting the USB-C Power**

**Request and Response #power**

```
→ request-line: POST http://<ip>/api/V1/SYS/MB/USBCPOWER/PowerLimit
→ body: <power>
← status-line: 200 OK
← body: <power>
```

**Parameters**

Parameter	Parameter description	Values	Value description
<power>	Power limit to the USB-C ports	0 1 2	Equal output power on the two ports (60W each) Port1 maximum, Port2 minimum (100W for U1) Port1 minimum, Port2 maximum (100W for U2)

**DIFFERENCE:** UCX-2x1-TPX-TX20 only has one USB-C port.

**Example**

```
→ request-line: POST http://192.168.0.50/api/V1/SYS/MB/USBCPOWER/PowerLimit
→ body: 2
← status-line: 200 OK
← body: 2
```

### 7.12.2. Setting the Displayport Alternate Mode Policy

**DIFFERENCE:** From firmware version v1.8.0, UCX-4x3-TPX-TX20 and UCX-2x1-TPX-TX20 models have **2 Lane Video** setting alongside **4 Lane Video** setting in case the latter is not supported.

#### Request and Response

→ request-line: POST http://<ip>/api/V1/MEDIA/USB/<usb-c\_port>/DpAltModePolicy  
 → body: <dp\_policy>  
 ← status-line: 200 OK  
 ← body: <dp\_policy>

#### Parameters

Parameter	Parameter description	Values	Value description
<usb-c_port>	USB-C port number	U1-U2	USB-C port number
<dp_policy>	The preferred video or USB data transmission	Auto	Auto: Taurus offers both operation modes described below. A BYOD device can choose between the two. 4 lane DP Alt mode operation (4K@60) is not guaranteed.
		Force C	It means 4 Lane Video setting.
		Force D	It means 2 Lane Video setting. It is used in case the 4 Lane mode is not supported.

#### Example

→ request-line: POST http://192.168.0.50/api/V1/MEDIA/USB/U2/DpAltModePolicy  
 → body: Auto  
 ← status-line: 200 OK  
 ← body: Auto

**ATTENTION!** Changing DpAltModePolicy is recommended before connecting a computer to the input.

### 7.12.3. Querying the Host Alternate Mode Support

#### Request and Response

→ request-line: GET http://<ip>/api/V1/MEDIA/USB/<usb-c\_port>/HostSupportsDpAltMode  
 ← status-line: 200 OK  
 ← body: <altmode\_support>

#### Parameters

Parameter	Parameter description	Value	Value description
<usb-c_port>	USB-C port number	U1-U2	USB-C port number
<altmode_support>		False	The host does not support the alternate mode.
		True	The host supports the alternate mode.

#### Example

→ request-line: GET http://192.168.0.50/api/V1/MEDIA/USB/U1/HostSupportsDpAltMode  
 ← status-line: 200 OK  
 ← body: true

### 7.12.4. Querying the Status of the Alternate Mode

#### Request and Response #dpaltmode #alternatemode #displayportalternatemode

→ request-line: GET http://<ip>/api/V1/MEDIA/USB/<usb-c\_port>/ActiveAltMode  
 ← status-line: 200 OK  
 ← body: <altmode\_state>

#### Parameters

Parameter	Parameter description	Value	Value description
<usb-c_port>	USB-C port number	U1-U2	USB-C port number
<altmode_state>		N/A	The host is not connected
		None	DP Alt mode is not active
		DP	DP Alt mode is active.

#### Example

→ request-line: GET http://192.168.0.50/api/V1/MEDIA/USB/U2/ActiveAltMode  
 ← status-line: 200 OK  
 ← body: DP



### 7.12.5. Querying the Port Data Role

#### Request and Response

→ request-line: GET http://<ip>/api/V1/MEDIA/USB/<usb-c\_port>/ActivePortDataRole  
 ← status-line: 200 OK  
 ← body: <data\_role>

#### Parameters

Parameter	Parameter description	Values	Value description
<usb-c_port>	USB-C port number	U1-U2	USB-C port number
<data_role>		N/A	No information about the data role.
		DFP	Downstream Facing Port (usually a Host / HUB ports) The port data role is configured as USB Host. This is for building up the connection (USB data transmission operates after the data role swap)
		UFP	Upstream Facing Port (usually a device)

#### Example

→ request-line: GET http://192.168.0.50/api/V1/MEDIA/USB/U2/ActivePortDataRole  
 ← status-line: 200 OK  
 ← body: UFP

### 7.12.6. Querying the Port Power Role

#### Request and Response #power

→ request-line: GET http://<ip>/api/V1/MEDIA/USB/<usb-c\_port>/ActivePortPowerRole  
 ← status-line: 200 OK  
 ← body: <power\_role>

#### Parameters

Parameter	Parameter description	Values	Value description
<usb-c_port>	USB-C port number	U1-U2	USB-C port number
<power_role>		N/A	No information about the power role.
		Sink	The port is configured as a sink.
		Source	The port is configured as a source

#### Example

→ request-line: GET http://192.168.0.50/api/V1/MEDIA/USB/U2/ActivePortPowerRole  
 ← status-line: 200 OK  
 ← body: Source

### 7.12.7. Setting the Port Power Role

#### Request and Response

→ request-line: POST http://<ip>/api/V1/MEDIA/USB/<usb-c\_port>/PortPowerRoleSetting  
 → body: <power\_role>  
 ← status-line: 200 OK  
 ← body: <power\_role>

#### Parameters

Parameter	Parameter description	Values	Value description
<usb-c_port>	USB-C port number	U1-U2	USB-C port number
<power_role>		Sink	The port is configured as a sink.
		Source	The port is configured as a source.
		Dual Role	The port is configured to be in Dual Power Role mode.

#### Example

→ request-line: POST http://192.168.0.50/api/V1/MEDIA/USB/U1/PortPowerRoleSetting  
 → body: Dual Role  
 ← status-line: 200 OK  
 ← body: Dual Role

## 7.13. EDID Management

**DIFFERENCE:** These commands are not available for HDMI-UCX-TPX-RX107.

### 7.13.1. Querying the Emulated EDIDs

#### Request and Response #edid

→ request-line: GET http://<ip>/api/V1/EDID/EdidStatus  
 ← status-line: 200 OK  
 ← body: ["<source>:E1"; "<source>:E2"; "<source>:E3"; "<source>:E4"]

#### Parameters

Parameter	Parameter description	Values	Value description
<source>	Source EDID memory place	F1-F120	Factory EDIDs
		U1-U14	User EDIDs
		D1-D2	Dynamic EDIDs

#### Example

→ request-line: GET http://192.168.0.50/api/V1/EDID/EdidStatus  
 ← status-line: 200 OK  
 ← body: ["F47:E1"; "F47:E2"; "F47:E3"; "F47:E4"]

Emulated EDID memory for input port is listed with the EDID number that is currently emulated on the input.

### 7.13.2. Querying the Validity of a Dynamic EDID

#### Request and Response

→ request-line: GET:http://<ip>/api/V1/EDID/D/D1/Validity  
 ← status-line: 200·OK  
 ← body: <validity>

#### Parameters

If the <validity> parameter is **true**, the EDID is valid. If the parameter is **false**, the EDID is invalid.

#### Example

→ request-line: GET http://192.168.0.50/api/V1/EDID/D/D1/Validity  
 ← status-line: 200 OK  
 ← body: true

The 'Validity' property is true, valid EDID is stored in D1 memory place.

### 7.13.3. Querying the Preferred Resolution of a User EDID

#### Request and Response

→ request-line: GET:http://<ip>/api/V1/EDID/U/<user\_edid>/PreferredResolution  
 ← status-line: 200·OK  
 ← body: <preferred\_resolution>

#### Example

→ request-line: GET http://192.168.0.50/api/V1/EDID/U/U2/PreferredResolution  
 ← status-line: 200 OK  
 ← body: 1920x1080p60.00Hz

INFO: Use the **Manufacturer** and **MonitorName** properties to query further information.

### 7.13.4. Emulating an EDID to an Input Port

#### Request and Response

→ request-line: POST:http://<ip>/api/V1/EDID/switch  
 → body: <source>:<destination>  
 ← status-line: 200 OK  
 ← body: <source>:<destination>

#### Parameters

Parameter	Parameter description	Values	Value description
<source>	Source EDID memory place	F1-F120	Factory EDIDs
		U1-U14	User EDIDs
		D1-D2	Dynamic EDIDs
<destination>	The emulated EDID memory of the desired input port	U1-U14	User EDIDs

#### Example

→ request-line: POST http://192.168.0.50/api/V1/EDID/switch  
 → body: F49:E2  
 ← status-line: 200 OK  
 ← body: OK

### 7.13.5. Emulating an EDID to All Input Ports

#### Request and Response

→ request-line: POST:http://<ip>/api/V1/EDID/switchAll  
 → body: <source>  
 ← status-line: 200 OK  
 ← body: OK

#### Parameters

Parameter	Parameter description	Values	Value description
<source>	Source EDID memory place	F1-F148	Factory EDIDs
		U1-U100	User EDIDs
		D1-D2	Dynamic EDIDs

#### Example

→ request-line: POST http://192.168.0.50/api/V1/EDID/switchAll  
 → body: F47  
 ← status-line: 200 OK  
 ← body: OK

### 7.13.6. Copying an EDID to User Memory

#### Request and Response

→ request-line: POST http://<ip>/api/V1/EDID/copy  
 → body: <source>:<destination>  
 ← status-line: 200 OK  
 ← body: OK

#### Parameters

Parameter	Parameter description	Values	Value description
<source>	Source EDID memory place	F1-F148	Factory EDIDs
		U1-U100	User EDIDs
		D1-D2	Dynamic EDIDs
<destination>	The emulated EDID memory of the desired input port	U1-U100	User EDIDs

#### Example

→ request-line: POST http://192.168.0.50/api/V1/EDID/copy  
 → body: F1:U2  
 ← status-line: 200 OK  
 ← body: OK

### 7.13.7. Deleting an EDID from User Memory

#### Request and Response

→ request-line: POST http://<ip>/api/V1/EDID/delete  
 → body: <user\_edid>  
 ← status-line: 200 OK  
 ← body: OK

#### Parameters

Parameter	Parameter description	Values	Value description
<user_edid>	The emulated EDID memory of the desired input port.	U1-U14	User EDIDs

#### Example

→ request-line: POST http://192.168.0.50/api/V1/EDID/delete  
 → body: U2  
 ← status-line: 200 OK  
 ← body: OK

### 7.13.8. Resetting the Emulated EDIDs

#### Request and Response

→ request-line: POST http://<ip>/api/V1/EDID/reset  
 INFO: The body has to be empty, and the content type should be text/plain.  
 ← status-line: 200 OK  
 ← body: OK

#### Example

→ request-line: POST http://192.168.0.50/api/V1/EDID/reset  
 ← status-line: 200 OK  
 ← body: OK

Calling this method switches all emulated EDIDs to a factory default one. See the table in the [Factory EDID List](#) section.

## 7.14. Ethernet Port Configuration

### 7.14.1. Setting the DHCP State

**ATTENTION!** When you change a network property, the new value is stored, but the **applySettings** method must always be called to apply the new settings. When two or more network parameters are changed, the **applySettings** method is enough to be called once as a final step.

#### Request and Response #dhcp #network #ipaddress

→ request-line: POST http://<ip>/api/V1/MANAGEMENT/NETWORK/DhcpEnabled  
 → body: <dhcp\_status>  
 ← status-line: 200 OK  
 ← body: <dhcp\_status>

#### Parameters

If the <dhcp\_status> parameter is **true**, the current IP address setting is DHCP, if the parameter is **false**, the current IP address is static.

**Example**

```

→ request-line: POST http://192.168.0.50/api/V1/MANAGEMENT/NETWORK/DhcpEnabled
→ body: true
← status-line: 200 OK
← body: true
→ request-line: POST http://192.168.0.50/api/V1/MANAGEMENT/NETWORK/applySettings
← status-line: 200 OK
← body: OK

```

INFO: The **applySettings** method will save and apply the new value and it will reboot the device.

INFO: The current setting can be queried by using the [GET Method](#).

**7.14.2. Changing the IP Address (Static)****Request and Response**

```

→ request-line: POST http://<ip>/api/V1/MANAGEMENT/NETWORK/StaticIpAddress
→ body: <IP_address>
← status-line: 200 OK
← body: <IP_address>

```

**Example**

```

→ request-line: POST http://192.168.0.50/api/V1/MANAGEMENT/NETWORK/StaticIpAddress
→ body: 192.168.0.100
← status-line: 200 OK
← body: 192.168.0.100
→ request-line: POST http://192.168.0.50/api/V1/MANAGEMENT/NETWORK/applySettings
← status-line: 200 OK
← body: OK

```

INFO: The **applySettings** method saves and applies the new value and it will reboot the device.

INFO: The current setting can be queried by using the [GET Method](#).

**7.14.3. Changing the Subnet Mask (Static)****Request and Response** #ipaddress

```

→ request-line: POST http://<ip>/api/V1/MANAGEMENT/NETWORK/StaticNetworkMask
→ body: <netmask>
← status-line: 200 OK
← body: <netmask>

```

**Example**

```

→ request-line: POST http://192.168.0.50/api/V1/MANAGEMENT/NETWORK/StaticNetworkMask
→ body: 255.255.255.0
← status-line: 200 OK
← body: 255.255.255.0
→ request-line: POST http://192.168.0.50/api/V1/MANAGEMENT/NETWORK/applySettings
← status-line: 200 OK
← body: OK

```

INFO: The **applySettings** method will save and apply the new value and it will reboot the device.

INFO: The current setting can be queried by using the [GET Method](#).

**7.14.4. Changing the Gateway Address (Static)****Request and Response**

```

→ request-line: POST http://<ip>/api/V1/MANAGEMENT/NETWORK/StaticGatewayAddress
→ body: <gw_address>
← status-line: 200 OK
← body: <gw_address>

```

**Example**

```

→ request-line: POST http://192.168.0.50/api/V1/MANAGEMENT/NETWORK/StaticGatewayAddress
→ body: 192.168.0.1
← status-line: 200 OK
← body: 192.168.0.1
→ request-line: POST http://192.168.0.50/api/V1/MANAGEMENT/NETWORK/applySettings
← status-line: 200 OK
← body: OK

```

INFO: The **applySettings** method will save and apply the new value and it will reboot the device.

INFO: The current setting can be queried by using the [GET Method](#).

### 7.14.5. Applying the Network Settings

#### Request and Response

→ request-line: POST http://<ip>/api/V1/MANAGEMENT/NETWORK/applySettings

INFO: The body has to be empty, and the content type should be text/plain.

← status-line: 200 OK

← body: OK

#### Example

→ request-line: POST http://192.168.0.50/api/V1/MANAGEMENT/NETWORK/applySettings

← status-line: 200 OK

← body: OK

All network settings that were changed are applied and network interface restarts.

### 7.14.6. Setting the Hostname

The host name is a property that can be used instead of the IP address when connecting to the device. It is also suitable for finding the device in the Device Discovery window of the LDC, see more details in the [Add New Favorite Device](#) section. Furthermore, it can be used to open the The Built-in Miniweb. If the IP address of the device is changing, the host name can be used as a fixed property.

After hostname changing, restarting the network services is required. New SSL certificate will be generated.

#### Request and Response

→ request-line: POST http://<ip>/api/V1/MANAGEMENT/NETWORK/HostName

→ body: <unique\_name>

← status-line: 200 OK

← body: <unique\_name>

#### Parameters

The <unique\_name> can be 1-64 character(s) long and the following are allowed for naming: the elements of the English alphabet and numbers. Hyphen (-) and dot (.) are also accepted, except as last character.

#### Example

→ request-line: POST http://192.168.0.50/api/V1/MANAGEMENT/NETWORK/HostName

→ body: room-switcher

← status-line: 200 OK

← body: room-switcher

## 7.15. Network Security

### 7.15.1. Enabling/Disabling the Ethernet Port

#### Request and Response

→ request-line: POST http://<ip>/api/V1/MEDIA/ETHERNET/<ethernet\_port>/Enabled

→ body: <status>

← status-line: 200 OK

← body: <status>

#### Parameters

Identifier	Parameter description	Parameter values
<ethernet_port>	Ethernet port number	P1-P7*
<status>	The port is disabled.	false
	The port is enabled.	true

\*The UCX-2x1-TPX-TX20 model has four Ethernet ports, plus it can control the two Ethernet ports of the HDMI-UCX-TPX-RX107 (P1-P6).

#### Example

→ request-line: POST http://192.168.0.50/api/V1/MEDIA/ETHERNET/P4/Enabled

→ body: false

← status-line: 200 OK

← body: false

### 7.15.2. Querying the Network Service Port Number

#### Request and Response #http #https

→ request-line: GET http://<ip>/api/V1/MANAGEMENT/NETWORK/SERVICES/<port>/Port

← status-line: 200-OK

← body: <port\_num>

#### Parameters

Identifier	Parameter description	Parameter values
<port>	Port type	HTTP / HTTPS / LW3 / SERIAL1 / SERIAL2
<port_num>	Port number	80 / 443 / 6107 / 8001 / 8002

#### Example

→ request-line: GET http://192.168.0.50/api/V1/MANAGEMENT/NETWORK/SERVICES/HTTP/Port

← status-line: 200 OK

← body: 80

### 7.15.3. Enabling/Disabling the Network Service Port

#### Request and Response

→ request-line: GET http://<ip>/api/V1/MANAGEMENT/NETWORK/SERVICES/<port>/Enabled  
 → body: <status>  
 ← status-line: 200 OK  
 ← body: <status>

#### Parameters

Identifier	Parameter description	Parameter values
<port>	Port type	HTTP / HTTPS
<status>	The port is enabled.	true
	The port is disabled.	false

#### Example

→ request-line: POST http://192.168.0.50/api/V1/MANAGEMENT/NETWORK/SERVICES/HTTP/Enabled  
 → body: false  
 ← status-line: 200 OK  
 ← body: false

### 7.15.4. Querying the Username for Authentication

INFO: UCX series deal with one user for authentication and the username (admin) can not be changed.

#### Request and Response

→ request-line: GET http://<ip>/api/V1/MANAGEMENT/NETWORK/AUTH/USER1/Name  
 ← status-line: 200 OK  
 ← body: admin

#### Example

→ request-line: GET http://192.168.0.50/api/V1/MANAGEMENT/NETWORK/AUTH/USER1/Name  
 ← status-line: 200 OK  
 ← body: admin

### 7.15.5. Setting a Password for Authentication

**ATTENTION!** The minimum character requirement for the password is 10 characters, and it can contain any UTF-8 character.

INFO: Due to security reasons, the password is not stored in any property, so it can not be queried. No password is set by default, setting a password before authorizing the authentication is necessary.

#### Request and Response #password

→ request-line: POST http://<ip>/api/V1/MANAGEMENT/NETWORK/AUTH/USER1/setPassword  
 → body: <password>  
 ← status-line: 200 OK  
 ← body: <password>

#### Parameters

Identifier	Parameter description	Value description
<password>	User defined password for authentication.	min. character length: 10 max. character length: 100 accepted characters: UTF-8 characters

#### Example

→ request-line: POST http://192.168.0.50/api/V1/MANAGEMENT/NETWORK/AUTH/USER1/setPassword  
 → body: #password12  
 ← status-line: 200 OK  
 ← body: #password12

### 7.15.6. Enabling the Authentication

INFO: Set the password before enabling the authentication, because no password is set by default. Restarting the HTTP(S) services is required to apply the authentication settings.

#### Request and Response

→ request-line: POST http://<ip>/api/V1/MANAGEMENT/NETWORK/SERVICES/<port>/AuthenticationEnabled  
 → body: <status>  
 ← status-line: 200 OK  
 ← body: <status>

#### Parameters

Identifier	Parameter description	Parameter values
<port>	Port type	HTTP / HTTPS
<status>	Authentication enabled	true
	Authentication disabled	false

#### Example

→ request-line: POST http://192.168.0.50/api/V1/MANAGEMENT/NETWORK/SERVICES/HTTP/AuthenticationEnabled  
 → body: false  
 ← status-line: 200 OK  
 ← body: false

### 7.15.7. Setting the VLAN ID

You can create separate networks by setting different VLAN IDs for the Ethernet ports. You can create any number of setups for limiting access to the corporate or management network or providing separate networks for each user. Default VLAN ID is 1 for all of the ports.

**DIFFERENCE:** From FW version v1.13.0b3, VLAN ID 1000 is reserved for the Management network.

#### Request and Response

```
→ request-line: POST http://<ip>/api/V1/MEDIA/ETHERNET/<port>/VlanMembership
→ body: <vlan_id>
← status-line: 200 OK
← body: <vlan_id>
```

#### Example

```
→ request-line: POST http://192.168.0.100/api/V1/MEDIA/ETHERNET/P1/VlanMembership
→ body: 2
← status-line: 200 OK
← body: 2
```

## 7.16. Serial Port Configuration

INFO: Port numbering can be found in the [Port Numbering](#) section.

### 7.16.1. BAUD Rate Setting

#### Request and Response *#rs-232 #rs232*

```
→ request-line: POST http://<ip>/api/V1/MEDIA/SERIAL/<serial_port>/Baudrate
→ body: <baudrate>
← status-line: 200 OK
← body: <baudrate>
```

#### Parameters

Identifier	Parameter description	Parameter values
<serial_port>	Serial port number	P1-P2
<baudrate>	Baud rate value	9600 19200 38400 57600 115200

#### Example

```
→ request-line: POST http://192.168.0.50/api/V1/MEDIA/SERIAL/P1/Baudrate
→ body: 19200
← status-line: 200 OK
← body: 19200
```

### 7.16.2. Stop Bits Setting

#### Request and Response *#rs232 #rs-232 #serial*

```
→ request-line: POST http://<ip>/api/V1/MEDIA/SERIAL/<serial_port>/StopBits
→ body: <stopbits>
← status-line: 200 OK
← body: <stopbits>
```

#### Parameters

Identifier	Parameter description	Parameter values
<serial_port>	Serial port number	P1-P2
<stopbits>	Stop bit value	1 2

**Example**

→ request-line: POST http://192.168.0.50/api/V1/MEDIA/SERIAL/P1/StopBits  
 → body: 1  
 ← status-line: 200 OK  
 ← body: 1

**7.16.3. Querying the Data Bits****Request and Response**

→ request-line: GET http://<ip>/api/V1/MEDIA/SERIAL/<serial\_port>/DataBits  
 ← status-line: 200 OK  
 ← body: <databits>

**Parameters**

Identifier	Parameter description	Parameter values
<serial_port>	Serial port number	P1-P2
<databits>	DataBits value	8 9

**Example**

→ request-line: GET http://192.168.0.50/api/V1/MEDIA/SERIAL/P1/DataBits  
 ← status-line: 200 OK  
 ← body: 8

**7.16.4. Parity Setting****Request and Response**

→ request-line: POST http://<ip>/api/V1/MEDIA/SERIAL/<serial\_port>/Parity  
 → body: <parity>  
 ← status-line: 200 OK  
 ← body: <parity>

**Parameters**

Identifier	Parameter description	Parameter values
<serial_port>	Serial port number	P1-P2
<parity>	Parity value	None Odd Even

**Example**

→ request-line: POST http://192.168.0.50/api/V1/MEDIA/SERIAL/P1/Parity  
 → body: None  
 ← status-line: 200 OK  
 ← body: None

**7.16.5. Querying the Serial over IP Port Number****Request and Response**

→ request-line: GET http://<ip>/api/V1/MEDIA/SERIAL/<serial\_port>/SERIALOVERIP/Port  
 ← status-line: 200 OK  
 ← body: <port\_nr>

**Parameters**

Identifier	Parameter description	Parameter values
<serial_port>	Serial port number	P1-P2; 1
<port_nr>	Serial over IP port number	8001 8002

**Example**

→ request-line: GET http://192.168.0.50/api/V1/MEDIA/SERIAL/P1/SERIALOVERIP/Port  
 ← status-line: 200 OK  
 ← body: 8001

**7.16.6. Enabling the Serial over IP Port****Request and Response** *#rs232 #rs-232 #serial*

→ request-line: POST http://<ip>/api/V1/MEDIA/SERIAL/<serial\_port>/SERIALOVERIP/Enabled  
 → body: <state>  
 ← status-line: 200 OK  
 ← body: <state>

**Parameters**

Identifier	Parameter description	Parameter values
<serial_port>	Serial port number	P1-P2; 1
<state>		true false

**Example**

→ request-line: POST http://192.168.0.50/api/V1/MEDIA/SERIAL/P1/SERIALOVERIP/Enabled  
 → body: false  
 ← status-line: 200 OK  
 ← body: false



## 7.17. Serial Port Messaging

### 7.17.1. Sending a Message via RS-232

**ATTENTION!** Serial message sending is implemented only via Lightware REST API. This function is not available with LW3 protocol command. `#message`

#### Request and Response

→ request-line: POST http://<ip>/api/V1/MEDIA/SERIAL/<serial\_port>/send  
 → body: <message>  
 ← status-line: 200 OK

#### Parameters

Identifier	Parameter description	Parameter values
<serial_port>	Serial port number	P1-P2; 1
<message>	Serial message	Any format is acceptable (text, binary, hexadecimal etc.), maximum message size is 100K. Escaping is unnecessary.

#### Example

→ request-line: POST http://192.168.0.50/api/V1/MEDIA/SERIAL/P1/send  
 → body: PWR0  
 ← status-line: 200 OK

The 'PWR0' message is sent out via the P1 serial port.

**INFO:** Taurus can receive a serial message in a special way. When a message is sent from the Taurus, the response from the connected device is accepted within 100 ms. The communication is closed after that time interval.

## 7.18. GPIO Port Configuration

**DIFFERENCE:** The HDMI-UCX-TPX-RX107 receiver does not have a GPIO port.

### 7.18.1. Setting the Direction of a GPIO Pin

#### Request and Response

→ request-line: POST http://<ip>/api/V1/MEDIA/GPIO/<port>/Direction  
 → body: <dir>  
 ← status-line: 200 OK  
 ← body: <dir>

#### Parameters

Parameter	Parameter description	Value	Value description
<dir>	The direction of the GPIO pin.	Input	input
		Output	output

#### Example

→ request-line: POST http://192.168.0.50/api/V1/MEDIA/GPIO/P1/Direction  
 → body: Input  
 ← status-line: 200 OK  
 ← body: Input

### 7.18.2. Setting the Output Level of a GPIO Pin

#### Request and Response

→ request-line: POST http://<ip>/api/V1/MEDIA/GPIO/<port>/Output  
 → body: <state>  
 ← status-line: 200 OK  
 ← body: <state>

#### Parameters

Parameter	Parameter description	Value	Value description
<value>	The output value of the GPIO pin.	High	high level
		Low	low level

#### Example

→ request-line: POST http://192.168.0.50/api/V1/MEDIA/GPIO/P1/Output  
 → body: High  
 ← status-line: 200 OK  
 ← body: High

### 7.18.3. Setting the Output Level for a Specified Time

#### Request and Response

→ request-line: POST http://<ip>/api/V1/MEDIA/GPIO/<port>/interval  
 → body: <value>;<time>  
 ← status-line: 200 OK  
 ← body: <value>;<time>

#### Parameters

Parameter	Parameter description	Value	Value description
<value>	The output value of the GPIO pin.	High	high level
		Low	low level
<time>	Duration of the desired value in seconds.	1-120	second(s)

#### Example

→ request-line: POST http://192.168.0.50/api/V1/MEDIA/GPIO/P1/interval  
 → body: Low;1  
 ← status-line: 200 OK  
 ← body: OK

### 7.18.4. Toggling the Level of a GPIO Pin

The output level can be changed from high to low and from low to high with the command below.

#### Request and Response

→ request-line: POST http://<ip>/api/V1/MEDIA/GPIO/<port>/toggle  
 INFO: The body has to be empty, and the content type should be text/plain.  
 ← status-line: 200 OK  
 ← body: OK

#### Example

→ request-line: POST http://192.168.0.50/api/V1/MEDIA/GPIO/P1/toggle  
 ← status-line: 200 OK  
 ← body: OK

### 7.19. OCS Port Configuration

**DIFFERENCE:** Occupancy sensor-related commands are available only from FW package 1.2.0b3.

**DIFFERENCE:** The UCX-4x3-TPX-TX20 and UCX-2x1-TPX-TX20 transmitters do not have an OCS port, however they can control the OCS port of the HDMI-UCX-TPX-RX107 receiver.

#### 7.19.1. Querying the Input Level of an OCS Pin

##### Request and Response #ocs

→ request-line: GET http://<ip>/api/V1/MEDIA/OCS/P1/InputLevel  
 ← status-line: 200-OK  
 ← body: <value>

##### Parameters

Parameter	Parameter description	Value	Value description
<value>	The input value of the OCS pin.	High	high level
		Low	low level

##### Example

→ request-line: GET http://192.168.0.50/api/V1/MEDIA/OCS/P1/InputLevel  
 ← status-line: 200 OK  
 ← body: Low

### 7.19.2. Setting the Sensor Type

#### Request and Response

→ request-line: POST http://<ip>/api/V1/MEDIA/OCS/P1/SensorType  
 → body: <sensor\_type>  
 ← status-line: 200 OK  
 ← body: <sensor\_type>

#### Parameters

Parameter	Parameter description	Value	Value description
<sensor_type>	It defines whether the low or high input level means the occupancy.	Active low	Occupancy status is 'Occupied' when the input level is low.
		Active high	Occupancy status is 'Occupied' when the input level is high (default value).

#### Example

→ request-line: POST http://192.168.0.50/api/V1/MEDIA/OCS/P1/SensorType  
 → body: Active low  
 ← status-line: 200 OK  
 ← body: Active low

### 7.19.3. Querying the Reported OCS State

#### Request and Response

→ request-line: GET http://<ip>/api/V1/MEDIA/OCS/P1/State  
 ← status-line: 200 OK  
 ← body: <status>

#### Parameters

Parameter	Parameter description	Value	Value description
<status>	It reports the occupancy state of the room depending on the sensor type.	Free	When the SensorType=Active high and the Inputlevel=Low or when SensorType=Active low and Inputlevel=High
		Occupied	When the SensorType=Active high and the Inputlevel=High or when SensorType=Active low and Inputlevel=Low

#### Example

→ request-line: GET http://192.168.0.50/api/V1/MEDIA/OCS/P1/State  
 ← status-line: 200 OK  
 ← body: Free

## 7.20. Updating the Device via REST API

### 7.20.1. Querying the Update REST API Version

#### Request and Response

→ request: GET http://<ip>/api/V1/MANAGEMENT/UPDATE/Version  
 ← response: <standard\_response>  
 ← body: <major>.<minor>

#### Parameters

Parameter	Parameter description	Values	Value description
<ip>	The IP address of the device separated with dots.		e.g.: 192.168.0.110
<standard_response>	Standard HTTP response	200 OK	The request has succeeded.
		400 Bad request	The request cannot be processed.
<major>	REST API major version number		
<minor>	REST API minor version number		

#### Example

→ request: GET http://192.168.0.110/api/V1/MANAGEMENT/UPDATE/Version  
 ← response: 200 OK  
 ← body: 1.1

### 7.20.2. The Updating Process

The API allows the device to update itself with an LFP2 FW package. This new approach means there is no need to run a software on the connected PC (in case of LDU2) for updating the Lightware device.

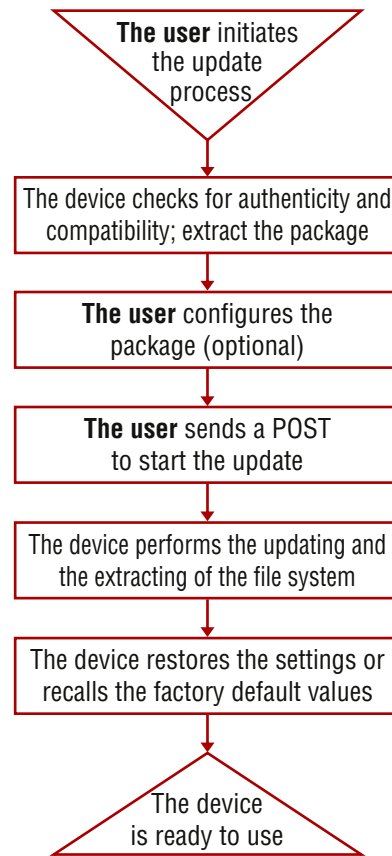

**The Updating Process**

#### The Updating Steps

1. The **User uploads the package** to a dedicated URL.
  - The package is being unpacked during the uploading process.
  - The package is checked by the device to see if they are compatible with each other.
2. The **User can set the uploaded package**.
  - The factory default settings can be recalled (this is the default setting of the package) or the current settings of the device can be restored (optional).
3. The **User starts the self-updating process** by sending a POST method.
  - The device performs the operations in connection with the update (e.g. file system replacement).
  - The device restores the previous settings to the new system, if it was set to.
4. The device is ready to use.

### 7.20.3. Uploading the Package

This step may take up to one or two minutes to finish as the size of the LFP2 package is approx. 100-150 MB (depends on the device and FW version).

#### Request and Response

- ➔ request: POST http://<ip/host>/api/V1/MANAGEMENT/UPDATE/Package
- ➔ body: <LFP2 file>
- ➔ content-type: application/octet-stream
- ⬅ response: <standard\_response>
- ⬅ body: <message>

#### Parameters

Parameter	Parameter description	Values	Value description
<ip/host>	The IP address or the host name of the device.		e.g.: 192.168.0.110, myDevice
<standard_response>	Standard HTTP response	200 OK	<message>: <b>OK</b> The request has succeeded; the whole package is extracted and the basic checks are done.
		400 Bad request	<message>: <b>Package incompatible: Incompatible partnumber: [...]</b> The request cannot be processed; error during the uploading/checking. e.g. the package is not compatible with the device. The <message> is in text/plain format.
		500 Internal Server Error	<message>: <b>Socket timeout</b> The package uploading was not successful. Please try it again.

#### Example

- ➔ request: POST http://192.168.0.110/api/V1/MANAGEMENT/UPDATE/Package
- ➔ body: (the LFP2 file)
- ⬅ response: 200 OK
- ⬅ body: OK

### 7.20.4. Configuration Parameters – Keep the Current Settings

This is an **optional step** that allows keeping the current settings of the device. The **default setting** of an update is to **recall the factory default** values. If you want to keep the current settings of the device, delete the 'dofactoryreset' file from the uploaded package as follows:

#### Request and Response

- ➔ request: DELETE http://<ip/host>/api/V1/MANAGEMENT/UPDATE/CONFIG/dofactoryreset
- ⬅ response: <standard\_response>
- ⬅ body: <message>

#### Parameters

Parameter	Parameter description	Values	Value description
<ip/host>	The IP address or the host name of the device.		e.g.: 192.168.0.110, myDevice
<standard_response>	Standard HTTP response	<b>200 OK</b>	"Deleted"
		<b>405 Method not allowed</b>	LFP2 package was not uploaded to the device.
		<b>500 Internal Server Error</b>	The file does not exist in the uploaded package (e.g. it was deleted previously). Continue the update process.

#### Example

- ➔ request: DELETE http://192.168.0.110/api/V1/MANAGEMENT/UPDATE/CONFIG/dofactoryreset
- ⬅ response: 200 OK
- ⬅ body: Deleted

### 7.20.5. Executing the Update

The command is for installing the uploaded package in place of the current system. This step may take up to 7 minutes.

#### Request and Response

- ➔ request: POST http://<ip/host>/api/V1/MANAGEMENT/UPDATE/update
- ➔ body: <payload>
- ➔ content-type: text/plain
- ⬅ response: <standard\_response>
- ⬅ body: <message>

#### Parameters

Parameter	Parameter description	Values	Value description
<ip/host>	The IP address or the host name of the device.		e.g.: 192.168.0.110, myDevice
<payload>	optional	<b>force</b>	The update can be forced to run in <b>Package incompatible</b> error state, but the security check cannot be bypassed ( <b>Package untrusted</b> state).
<standard_response>	Standard HTTP response	<b>200 OK</b>	The request has succeeded; the update process finished successfully.
		<b>400 Bad request</b>	The request cannot be processed. it may happen that the uploaded package is not compatible with the device ( <b>Package incompatible</b> error state) and the <b>force</b> payload was <b>not</b> used.

**ATTENTION!** Please note that running a **forced update** can make the device inoperable.

#### Example

- ➔ request: POST http://192.168.0.110/api/V1/MANAGEMENT/UPDATE/update
- ⬅ response: 200 OK
- ⬅ body: OK

When the 'force' payload is used:

- ➔ request: POST http://192.168.0.110/api/V1/MANAGEMENT/UPDATE/update
- ➔ body: force
- ➔ content-type: RAW (JSON)
- ⬅ response: 200 OK
- ⬅ body: OK

### 7.20.6. Querying the State of the Updating Process

This command is for querying the current state of the updating process.

#### Request and Response

→ request: GET http://<ip/host>/api/V1/MANAGEMENT/UPDATE/Status

← response: <standard\_response>

← body: <message>

#### Parameters

Parameter	Parameter description	Values	Value description
<ip/host>	The IP address or the host name of the device.		e.g.: 192.168.0.110, myDevice
<standard_response>	Standard HTTP response	200 OK	The request has succeeded. <message> states: <b>Idle</b> : not active, update has not started yet. <b>Package uploading</b> : updating and checking is in progress. <b>Package ready</b> : uploading is done, checking is successful.
		400 Bad Request	The request cannot be processed. <message> states: <b>Package incompatible</b> : the uploaded package is not compatible with the device. <b>Package untrusted</b> : the uploaded package is not secure. <b>Failed</b> : the update is not successful.

INFO: Please note that while the new firmware is being programmed in the device, it cannot send a response for a request. Thus the current state cannot be requested either.

After the firmware update is finished successfully, the device would send the 'Idle' response when requesting its status with this command.

#### Example

→ request: GET http://192.168.0.110/api/V1/MANAGEMENT/UPDATE/Status

← response: 200 OK

← body: Package uploading

## 7.21. Lightware REST API Quick Summary

### System Commands

#### Setting the Device Label

- request-line: POST·http://<ip>/api/V1/MANAGEMENT/LABEL/DeviceLabel
- body: <custom\_name>

#### Resetting the Device

- request-line: POST·http://<ip>/api/V1/SYS/DEVICES/<TX/RX>/restart

#### Restoring the Factory Default Settings

- request-line: POST·http://<ip>/api/V1/SYS/DEVICES/<TX/RX>/factoryDefaults

#### Querying the Firmware Package Version

- request-line: GET·http://<ip>/api/V1/MANAGEMENT/UID/PACKAGE/Version

#### Control Lock

- request-line: POST·http://<ip>/api/V1/MANAGEMENT/UI/ControlLock
- body: <lock\_status>

#### Setting the Current Time

- request-line: POST·http://<ip>/api/V1/MANAGEMENT/DATETIME/setTime
- body: <current\_time>

#### Identifying the Device

- request-line: POST http://<ip>/api/V1/MANAGEMENT/UI/identifyMe

#### Toggling the Dark Mode Setting

- request-line: POST·http://<ip>/api/V1/MANAGEMENT/UI/DARKMODE/Enable
- body: <mode\_state>

#### Setting the Delay of the Dark Mode

- request-line: POST·http://<ip>/api/V1/MANAGEMENT/UI/DARKMODE/Delay
- body: <delay\_time>

### Video Port Settings - General

#### Switching the Video Input

- request-line: POST·http://<ip>/api/V1/MEDIA/VIDEO/XP/switch
- body: <in>:<out>

#### Switching an Input to All Outputs

- request-line: POST·http://<ip>/api/V1/MEDIA/VIDEO/XP/switchAll
- body: <in>

#### Locking the Video Port

- request-line: POST·http://<ip>/api/V1/MEDIA/VIDEO/XP/<port>/Lock
- body: <locked\_state>

#### Muting the Video Port

- request-line: POST·http://<ip>/api/V1/MEDIA/VIDEO/XP/<port>/Mute
- body: <muted\_state>

#### Setting the Autoselect Policy

- request-line: POST·http://<ip>/api/V1/MEDIA/VIDEO/AUTOSELECT/<out>/Policy
- body: <autoselect\_mode>

#### Changing the Autoselect-Included Input Ports

- request-line: POST·http://<ip>/api/V1/MEDIA/VIDEO/AUTOSELECT/<out>/<in>/Included
- body: <state>

#### Changing the Input Port Priority

- request-line: POST·http://<ip>/api/V1/MEDIA/VIDEO/AUTOSELECT/<out>/<in>/Priority
- body: <prio\_num>

#### Querying the Connected Source

- request-line: GET·http://<ip>/api/V1/MEDIA/VIDEO/XP/<out>/ConnectedSource

#### Querying the Connected Destinations

- request-line: GET·http://<ip>/api/V1/MEDIA/VIDEO/XP/<in>/ConnectedDestinations

#### Querying the Input Switching Capability

- request-line: GET·http://<ip>/api/V1/MEDIA/VIDEO/XP/<out>/SWITCHABLE/<in>

#### Query the Video Signal Presence

- request-line: GET·http://<ip>/api/V1/MEDIA/VIDEO/<port>/SignalPresent

#### HDCP Setting (Input Port)

- request-line: POST·http://<ip>/api/V1/MEDIA/VIDEO/<in>/HDCP/AllowedHdcpVersion
- body: <allowed\_hdcp>

#### HdcpMode

- request-line: POST·http://<ip>/api/V1/MEDIA/VIDEO/<out>/HdcpMode
- body: <hdcp\_mode>

#### Querying the Embedded Audio Presence

- request-line: GET·http://<ip>/api/V1/MEDIA/VIDEO/<port>/EmbeddedAudioPresent

#### Muting the Embedded Audio

- request-line: POST·http://<ip>/api/V1/MEDIA/VIDEO/<port>/EmbeddedAudioMute
- body: <mute\_state>

#### Setting the Output Signal Type

- request-line: POST·http://<ip>/api/V1/MEDIA/VIDEO/<out>/OutputSignalType
- body: <signal\_type>

**Turning on Output 5V**

- ➔ request-line: POST·http://<ip>/api/V1/MEDIA/VIDEO/<out>/Output5VMode
- ➔ body: <5V\_pwr>

**Welcome Screen Settings****Displaying the Welcome Screen Image**

- ➔ request-line: POST·http://<ip>/api/V1/MEDIA/VIDEO/I5/WELCOMESCREEN/ImageEnabled
- ➔ body: <image\_state>

**Displaying the Welcome Screen Text**

- ➔ request-line: POST·http://<ip>/api/V1/MEDIA/VIDEO/I5/WELCOMESCREEN/MessageEnabled
- ➔ body: <text\_state>

**Setting the Welcome Screen Text**

- ➔ request-line: POST·http://<ip>/api/V1/MEDIA/VIDEO/I5/WELCOMESCREEN/MessageText
- ➔ body: <text>

**Resetting the Welcome Screen Image**

- ➔ request-line: POST·http://<ip>/api/V1/MEDIA/VIDEO/I5/WELCOMESCREEN/resetImage

**Video Port Settings - USB-C Related Commands****Restarting the Link Training**

- ➔ request-line: POST·http://<ip>/api/V1/MEDIA/VIDEO/<in>/DP/restartLinkTraining

**CEC Command Sending****Simple CEC Code Sending**

- ➔ request-line: POST·http://<ip>/api/V1/MEDIA/VIDEO/<port>/CEC/send
- ➔ body: <command>

**Remote Control Code Sending**

- ➔ request-line: POST·http://<ip>/api/V1/MEDIA/VIDEO/<port>/CEC/sendUserControlClick
- ➔ body: <command>

**Audio Port Settings****Switching the Audio Input**

- ➔ request-line: POST·http://<ip>/api/V1/MEDIA/AUDIO/XP/switch
- ➔ body: <audio\_in>:03

**Querying the Connected Source**

- ➔ request-line: GET·http://<ip>/api/V1/MEDIA/AUDIO/XP/03/ConnectedSource

**Querying the Connected Destinations**

- ➔ request-line: GET·http://<ip>/api/V1/MEDIA/AUDIO/XP/<audio\_in>/ConnectedDestinations

**Setting the Autoselect Operation Mode**

- ➔ request-line: POST·http://<ip>/api/V1/MEDIA/AUDIO/AUTOSELECT/<audio\_out>/Policy
- ➔ body: <op\_mode>

**Setting the Followed Video Port to Autoselect**

- ➔ request-line: POST·http://<ip>/api/V1/MEDIA/AUDIO/AUTOSELECT/03/VideoFollowPort
- ➔ body: <out>

**Locking the Audio Port**

- ➔ request-line: POST·http://<ip>/api/V1/MEDIA/AUDIO/XP/<audio\_port>/Lock
- ➔ body: <locked\_state>

**Muting the Audio Port 1.**

- ➔ request-line: POST·http://<ip>/api/V1/MEDIA/AUDIO/XP/<audio\_port>/Mute
- ➔ body: <muted\_state>

**Muting the Audio Port 2.**

- ➔ request-line: POST·http://<ip>/api/V1/MEDIA/AUDIO/<audio\_port>/Mute
- ➔ body: <muted\_state>

**Querying the Audio Signal Presence**

- ➔ request-line: GET·http://<ip>/api/V1/MEDIA/AUDIO/<audio\_port>/SignalPresent

**Analog Audio Output Volume (dB) Setting**

- ➔ request-line: POST·http://<ip>/api/V1/MEDIA/AUDIO/<audio\_port>/VolumedB
- ➔ body: <level>

**Analog Audio Output Volume Percent Setting**

- ➔ request-line: POST·http://<ip>/api/V1/MEDIA/AUDIO/<audio\_port>/VolumePercent
- ➔ body: <percent>

**Setting the Balance**

- ➔ request-line: POST·http://<ip>/api/V1/MEDIA/AUDIO/<audio\_port>/Balance
- ➔ body: <level>

**Analog Audio Output Level Setting by Steps (dB)**

- ➔ request-line: POST·http://<ip>/api/V1/MEDIA/AUDIO/<audio\_port>/stepVolumedB
- ➔ body: <step>

**Analog Audio Output Level Setting by Steps in Percent**

- ➔ request-line: POST·http://<ip>/api/V1/MEDIA/AUDIO/<audio\_port>/stepVolumePercent
- ➔ body: <step>

**Analog Audio Output Balance Setting by Steps**

- ➔ request-line: POST·http://<ip>/api/V1/MEDIA/AUDIO/<audio\_port>/stepBalance
- ➔ body: <step>



**USB Port Settings****Switching the USB Input**

- request-line: POST·http://<ip>/api/V1/MEDIA/USB/XP/switch<host>/H1
- body: <host>:H1

**Querying the Connected Source**

- request-line: GET·http://<ip>/api/V1/MEDIA/USB/XP/H1/ConnectedSource

**Querying the Connected Destinations**

- request-line: GET·http://<ip>/api/V1/MEDIA/USB/XP/<host>/ConnectedDestinations

**Locking the USB Port**

- request-line: POST·http://<ip>/api/V1/MEDIA/USB/XP/<usb\_port>/Lock
- body: <locked\_state>

**Setting the 5V Sending to the USB Peripherals**

- request-line: POST·http://<ip>/api/V1/MEDIA/USB/H1/<device\_id>/Power5VMode
- body: <device\_pwr>

**Setting the USB Autoselect Policy**

- request-line: POST·http://<ip>/api/V1/MEDIA/USB/AUTOSELECT/H1/Policy
- body: <op\_mode>

**Setting the Followed Video Port to Autoselect**

- request-line: POST·http://<ip>/api/V1/MEDIA/USB/AUTOSELECT/H1/VideoFollowPort
- body: <out>

**Changing the Autoselect Included USB Ports**

- request-line: POST·http://<ip>/api/V1/MEDIA/USB/AUTOSELECT/H1/<host>/Included
- body: <state>

**Changing the USB Port Priority**

- request-line: POST·http://<ip>/api/V1/MEDIA/USB/AUTOSELECT/H1/<host>/Priority
- body: <prio\_num>

**USB Port Settings - USB-C Related Commands****Setting the USB-C Power**

- request-line: POST·http://<ip>/api/V1/SYS/MB/USBCPOWER/PowerLimit
- body: <power>

**Setting the Displayport Alternate Mode Policy**

- request-line: POST·http://<ip>/api/V1/MEDIA/USB/<usb-c\_port>/DpAltModePolicy
- body: <dp\_policy>

**Querying the Host Alternate Mode Support**

- request-line: GET·http://<ip>/api/V1/MEDIA/USB/<usb-c\_port>/HostSupportsDpAltMode

**Querying the Status of the Alternate Mode**

- request-line: GET·http://<ip>/api/V1/MEDIA/USB/<usb-c\_port>/ActiveAltMode

**Querying the Port Data Role**

- request-line: GET·http://<ip>/api/V1/MEDIA/USB/<usb-c\_port>/ActivePortDataRole

**Querying the Port Power Role**

- request-line: GET·http://<ip>/api/V1/MEDIA/USB/<usb-c\_port>/ActivePortPowerRole

**Setting the Port Power Role**

- request-line: POST·http://<ip>/api/V1/MEDIA/USB/<usb-c\_port>/PortPowerRoleSetting
- body: <power\_role>

**EDID Management****Querying the Emulated EDIDs**

- request-line: GET·http://<ip>/api/V1/EDID/EdidStatus

**Querying the Validity of a Dynamic EDID**

- request-line: GET·http://<ip>/api/V1/EDID/D/D1/Validity

**Querying the Preferred Resolution of a User EDID**

- request-line: GET·http://<ip>/api/V1/EDID/U/<user\_edid>/PreferredResolution

**Emulating an EDID to an Input Port**

- request-line: POST·http://<ip>/api/V1/EDID/switch
- body: <source>:<destination>

**Emulating an EDID to All Input Ports**

- request-line: POST·http://<ip>/api/V1/EDID/switchAll
- body: <source>

**Copying an EDID to User Memory**

- request-line: POST·http://<ip>/api/V1/EDID/copy
- body: <source>:<destination>

**Deleting an EDID from User Memory**

- request-line: POST·http://<ip>/api/V1/EDID/delete
- body: <user\_edid>

**Resetting the Emulated EDIDs**

- request-line: POST·http://<ip>/api/V1/EDID/reset

**Ethernet Port Configuration****Setting the DHCP State**

- request-line: POST·http://<ip>/api/V1/MANAGEMENT/NETWORK/DhcpEnabled
- body: <dhcp\_status>

**Changing the IP Address (Static)**

- ➔ request-line: POST·http://<ip>/api/V1/MANAGEMENT/NETWORK/StaticIpAddress
- ➔ body: <IP\_address>

**Changing the Subnet Mask (Static)**

- ➔ request-line: POST·http://<ip>/api/V1/MANAGEMENT/NETWORK/StaticNetworkMask
- ➔ body: <netmask>

**Changing the Gateway Address (Static)**

- ➔ request-line: POST·http://<ip>/api/V1/MANAGEMENT/NETWORK/StaticGatewayAddress
- ➔ body: <gw\_address>

**Applying the Network Settings**

- ➔ request-line: POST·http://<ip>/api/V1/MANAGEMENT/NETWORK/applySettings

**Setting the Hostname**

- ➔ request-line: POST·http://<ip>/api/V1/MANAGEMENT/NETWORK/HostName
- ➔ body: <unique\_name>

**Network Security****Enabling/Disabling the Ethernet Port**

- ➔ request-line: POST·http://<ip>/api/V1/MEDIA/ETHERNET/<ethernet\_port>/Enabled
- ➔ body: <status>

**Querying the Network Service Port Number**

- ➔ request-line: GET·http://<ip>/api/V1/MANAGEMENT/NETWORK/SERVICES/<port>/Port

**Enabling/Disabling the Network Service Port**

- ➔ request-line: GET·http://<ip>/api/V1/MANAGEMENT/NETWORK/SERVICES/<port>/Enabled
- ➔ body: <status>

**Querying the Username for Authentication**

- ➔ request-line: GET·http://<ip>/api/V1/MANAGEMENT/NETWORK/AUTH/USER1/Name

**Setting a Password for Authentication**

- ➔ request-line: POST·http://<ip>/api/V1/MANAGEMENT/NETWORK/AUTH/USER1/setPassword
- ➔ body: <password>

**Enabling the Authentication**

- ➔ request-line: POST·http://<ip>/api/V1/MANAGEMENT/NETWORK/SERVICES/<port>/AuthenticationEnabled
- ➔ body: <status>

**Setting the VLAN ID**

- ➔ request-line: POST·http://<ip>/api/V1/MEDIA/ETHERNET/<port>/VlanMembership
- ➔ body: <vlan\_id>

**Serial Port Configuration****BAUD Rate Setting**

- ➔ request-line: POST·http://<ip>/api/V1/MEDIA/SERIAL/<serial\_port>/Baudrate
- ➔ body: <baudrate>

**Stop Bits Setting**

- ➔ request-line: POST·http://<ip>/api/V1/MEDIA/SERIAL/<serial\_port>/StopBits
- ➔ body: <stopbits>

**Querying the Data Bits**

- ➔ request-line: GET·http://<ip>/api/V1/MEDIA/SERIAL/<serial\_port>/DataBits

**Parity Setting**

- ➔ request-line: POST·http://<ip>/api/V1/MEDIA/SERIAL/<serial\_port>/Parity
- ➔ body: <parity>

**Querying the Serial over IP Port Number**

- ➔ request-line: GET·http://<ip>/api/V1/MEDIA/SERIAL/<serial\_port>/SERIALOVERIP/Port

**Enabling the Serial over IP Port**

- ➔ request-line: POST·http://<ip>/api/V1/MEDIA/SERIAL/<serial\_port>/SERIALOVERIP/Enabled
- ➔ body: <state>

**Serial Port Messaging****Sending a Message via RS-232**

- ➔ request-line: POST·http://<ip>/api/V1/MEDIA/SERIAL/<serial\_port>/send
- ➔ body: <message>

**GPIO Port Configuration****Setting the Direction of a GPIO Pin**

- ➔ request-line: POST·http://<ip>/api/V1/MEDIA/GPIO/<port>/Direction
- ➔ body: <dir>

**Setting the Output Level of a GPIO Pin**

- ➔ request-line: POST·http://<ip>/api/V1/MEDIA/GPIO/<port>/Output
- ➔ body: <state>

**Setting the Output Level for a Specified Time**

- ➔ request-line: POST·http://<ip>/api/V1/MEDIA/GPIO/<port>/interval
- ➔ body: <value>;<time>

**Toggling the Level of a GPIO Pin**

- ➔ request-line: POST·http://<ip>/api/V1/MEDIA/GPIO/<port>/toggle

## OCS Port Configuration

### Querying the Input Level of an OCS Pin

→ request-line: GET·http://<ip>/api/V1/MEDIA/OCS/P1/InputLevel

### Setting the Sensor Type

→ request-line: POST·http://<ip>/api/V1/MEDIA/OCS/P1/SensorType

→ body: <sensor\_type>

### Querying the Reported OCS State

→ request-line: GET·http://<ip>/api/V1/MEDIA/OCS/P1/State

## Updating the Device via REST API

### Querying the Update REST API Version

→ request: GET·http://<ip>/api/V1/MANAGEMENT/UPDATE/Version

### Uploading the Package

→ request: POST·http://<ip/host>/api/V1/MANAGEMENT/UPDATE/Package

→ body: <LFP2 file>

→ content-type: application/octet-stream

### Configuration Parameters – Keep the Current Settings

→ request: DELETE·http://<ip/host>/api/V1/MANAGEMENT/UPDATE/CONFIG/dofactoryreset

### Executing the Update

→ request: POST·http://<ip/host>/api/V1/MANAGEMENT/UPDATE/update

→ body: <payload>

→ content-type: text/plain

### Querying the State of the Updating Process

→ request: GET·http://<ip/host>/api/V1/MANAGEMENT/UPDATE/Status

# 8

## LW3 Programmers' Reference

The device can be controlled through Lightware 3 (LW3) protocol commands to ensure the compatibility with other Lightware products. The supported LW3 commands are described in this chapter.

- ▶ [OVERVIEW](#)
- ▶ [INSTRUCTIONS FOR THE TERMINAL APPLICATION USAGE](#)
- ▶ [WEBSOCKET \(WS\) OR SECURED WEBSOCKET \(WSS\) USAGE](#)
- ▶ [PROTOCOL RULES](#)
- ▶ [SYSTEM COMMANDS](#)
- ▶ [VIDEO PORT SETTINGS - GENERAL](#)
- ▶ [WELCOME SCREEN SETTINGS](#)
- ▶ [VIDEO PORT SETTINGS - USB-C RELATED COMMANDS](#)
- ▶ [CEC COMMAND SENDING](#)
- ▶ [AUDIO PORT SETTINGS](#)
- ▶ [USB PORT SETTINGS](#)
- ▶ [USB PORT SETTINGS - USB-C RELATED COMMANDS](#)
- ▶ [EDID MANAGEMENT](#)
- ▶ [ETHERNET PORT CONFIGURATION](#)
- ▶ [REMOTE POWER](#)
- ▶ [NETWORK SECURITY](#)
- ▶ [SERIAL PORT CONFIGURATION](#)
- ▶ [SENDING A MESSAGE VIA RS-232](#)
- ▶ [GPIO PORT CONFIGURATION](#)
- ▶ [OCS PORT CONFIGURATION](#)
- ▶ [LW3 COMMANDS - QUICK SUMMARY](#)

## 8.1. Overview

The Lightware Protocol #3 (LW3) is implemented in almost all new Lightware devices (matrix switchers, signal extenders and distribution amplifiers) since 2012. The protocol is ASCII-based and all commands are terminated with a carriage return (Cr, '\r') and line feed (Lf, '\n') pair. It is organized as a tree structure that provides outstanding flexibility and user-friendly handling with 'nodes', 'properties' and 'methods'. The **Advanced View** of the Lightware Device Controller software is the perfect tool for browsing and learning how the LW3 protocol can be used in practice.

## 8.2. Instructions for the Terminal Application Usage

### Terminal Application

The LW3 protocol commands can be applied to the receiver using a terminal application. You need to install one of them on your control device, for example **Putty** or **CLI**. `#terminal`

### Establishing Connection

Follow the steps to establish connection to the receiver:

- Step 1.** Connect the receiver to a LAN over Ethernet.
- Step 2.** Open the terminal application (e.g. Putty).
- Step 3.** Add the **IP address** of the device (default: 192.168.0.100) and the **port number (6107)**.
- Step 4.** Select the **Raw** connection type, and open the connection.

Once the terminal window is opened, you can enter the LW3 protocol commands, which are listed in the following sections.

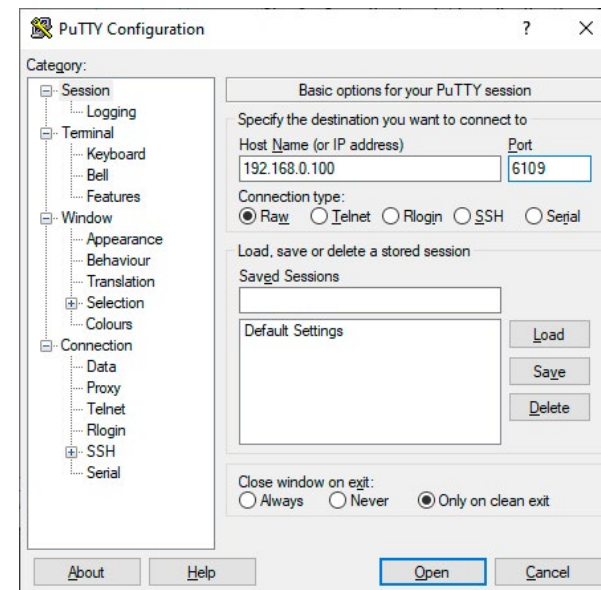

```

192.168.0.100 - PuTTY
GET /MEDIA/VIDEO/XP.SourcePortStatus
pr /MEDIA/VIDEO/XP.SourcePortStatus=T00AA;T00AA
CALL /MEDIA/VIDEO/XP:switch(I1:02)
mO /MEDIA/VIDEO/XP:switch
1700#GET /EDID.*
{1700
pr /EDID.EdidStatus=F47:E1;F47:E2
m- /EDID:copy
m- /EDID:delete
m- /EDID:reset
m- /EDID:switch
m- /EDID:switchAll
}

```

**LW3 protocol command communication in a terminal window**

## 8.3. Websocket (WS) or Secured Websocket (WSS) Usage

UCX-TPX series switcher transmitter provides WS/WSS services on its 80 (for WS) and 443 (for WSS) ports to control the device with LW3 protocol commands. For more details about the websocket, see the [802.1x Authentication](#) section.

The LW3 node tree is available after opening a session with the device on the following path:

- `ws://<ip>/lw3`
- `wss://<ip>/lw3`

### WebSocket Client Application

#### Establishing Connection

Follow the steps to establish connection to the switcher:

- Step 1.** Connect the receiver to a LAN over Ethernet.
- Step 2.** Open the websocket client (e.g. Simple websocket Client).
- Step 3.** Add the **IP address** of the device (default: DHCP): `ws://<ip>/lw3` or `wss://<ip>/lw3`
- Step 4.** Press the open/connect button.
- Step 5.** Once connected, enter a message and press the Send button.
- Step 6.** Press the Close/Disconnect button to end the session.

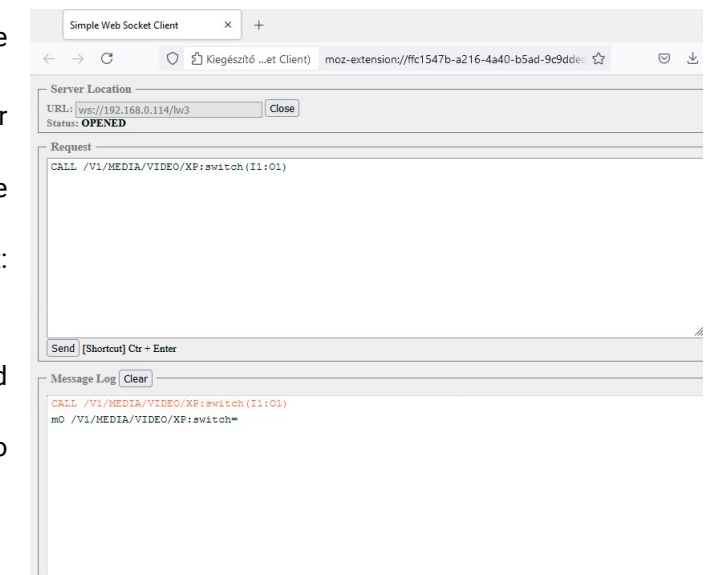

## 8.4. Protocol Rules

### 8.4.1. LW3 Tree Structure and Command Structure (examples)

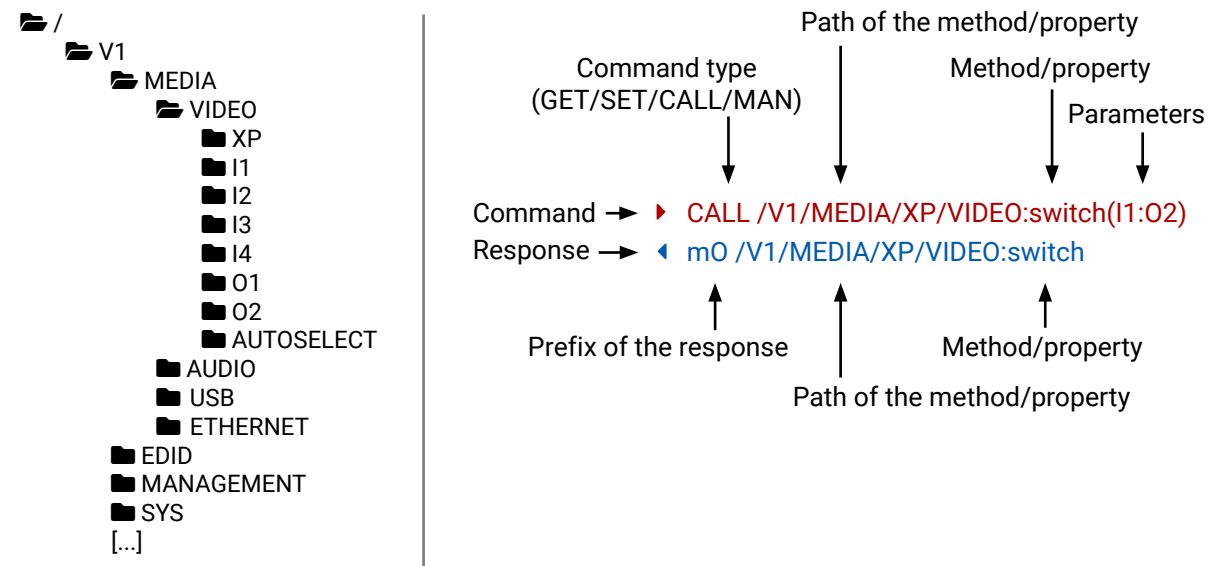

### 8.4.2. General Rules

- All names and parameters are **case-sensitive**.
- The nodes are separated by a slash ('/') character.
- The node name can contain the elements of the English alphabet and numbers.
- The command lines have to be closed by Carriage return and Line Feed (CrLf).
- Use the **TCP port no. 6107** when using LW3 protocol over Ethernet.
- The length of a line (command/response, command type / prefix, path, method/property and parameters together) can be **max. 800 bytes**.
- When a command is issued by the device, the received response cannot be processed by the CPU.
- The node paths describe the exact location of the node, listing each parent node up to the root.

### 8.4.3. Legend for the Control Commands

#### Command and Response – Example

- ▶ GET-/V1/MEDIA/VIDEO/I2.SignalPresent
- ◀ pr-/V1/MEDIA/VIDEO/I2.SignalPresent=<signal\_present>

Format	Description
<in>	Input port number
<out>	Output port number
<port>	Input or output port number
<loc>	Location number
<parameter>	Specific parameter defined and described in the command
<u>&lt;expression&gt;</u>	Batched parameters: the underline means that more expressions or parameters can be placed by using a semicolon, e.g. <b>I2;I4;I5</b> or <b>F27:E1;F47:E2</b>
▶	Sent command
◀	Received response
.	Space character

Further not listed <parameters> are defined at each command.

### 8.4.4. Command Types

#### GET Command

The **GET** command can be used to get the child nodes, properties and methods of a specific node. It can also be used to get the value of a property. Use the dot character (.) when addressing a property:

- ▶ **GET /V1/.SerialNumber**
- ◀ **pr /V1/.SerialNumber=87654321**

#### GETALL Command

The **GETALL** command can be used to get all child nodes, properties and methods of a node with one command.

- ▶ **GETALL /V1/MEDIA/UART**
- ◀ **ns /V1/MEDIA/UART/RECOGNIZER**
- ◀ **ns /V1/MEDIA/UART/P1**
- ◀ **ns /V1/MEDIA/UART/P2**
- ◀ **pr /V1/MEDIA/UART.PortCount=2**
- ◀ **pr /V1/MEDIA/UART.PortUi=P1:12209;P2:12224**
- ◀ **pr /V1/MEDIA/UART.P1=Local RS-232**
- ◀ **pr /V1/MEDIA/UART.P2=TPS in RS-232**

#### SET Command

The **SET** command can be used to modify the value of a property. Use the dot character (.) when addressing the property:

- ▶ **SET /V1/MEDIA/VIDEO/O1.TpgPattern=CYCLE**
- ◀ **pw /V1/MEDIA/VIDEO/O1.TpgPattern=CYCLE**

#### CALL Command

A method can be invoked by the **CALL** command. Use the colon character (:) when addressing the method:

- ▶ **CALL /V1/EDID:switchAll(F49)**
- ◀ **mO /V1/EDID:switchAll**

#### MAN Command

The manual is a human readable text that describes the syntax and provides a hint for how to use the primitives. For every node, property and method in the tree there is a manual, type the MAN command to get the manual:

- ▶ **MAN /V1/MEDIA/VIDEO/O1.Pwr5vMode**
- ◀ **pm /V1/MEDIA/VIDEO/O1.Pwr5vMode ["0" | "1" | "2"] 0 - Auto, 1 - Always On, 2 - Always Off**

### 8.4.5. Prefix Summary

**DEFINITION:** The prefix is a two-character long code that describes the type of the response.

The following prefixes are defined in the LW3 protocol:

Prefix	Description	Prefix	Description
n-	a node	nr	remote node
nE	an error for a node	pm	a manual for the property
nm	a manual for a node	m-	a method
pr	a read-only property	mO	a response after a success method execution
pw	read-write property	mF	a response after a failed method execution
pE	an error for the property	mE	an error for a method
ns	symlink node	mm	a manual for a method
nv	virtual node		

### 8.4.6. Error Messages

There are several error messages defined in the LW3 protocol, all of them have a unique error number.

- ▶ **CALL /V1/MEDIA/VIDEO/XP:lock(IA)**
- ◀ **mE /V1/MEDIA/VIDEO/XP:lock %E002:Not exist**

### 8.4.7. Escaping

**DEFINITION:** An escape sequence is a sequence of characters that does not represent itself when used inside a character or string literal, but is translated into another character or a sequence of characters.

Property values and method parameters can contain characters that are used as control characters in the protocol. They must be escaped. The escape character is the backslash ('\') and escaping means injecting a backslash before the character that should be escaped (like in C language).

Control characters are the following: \ { } # % ( ) \r \n \t

The **original** message: **CALL /V1/MEDIA/UART/P1:sendMessage(Set(01))**

The **escaped** message: **CALL /V1/MEDIA/UART/P1:sendMessage(Set\01\))**

### 8.4.8. Signature

**DEFINITION:** The signature is a four-digit-long hexadecimal value that can be optionally placed before every command to keep a command and the corresponding responses together as a group.

Each line is terminated with carriage return (Cr, '\r') and line feed (Lf, '\n') characters. In several cases the number of the lines in the response cannot be determined in advance, e.g. the client intends to receive the whole response and also wants to be sure that the received lines belong together and to the same command. In these cases, a special feature, the 'signature' can be used. The response to that particular command will also be preceded by the signature, and the corresponding lines will be between brackets:

```
▶ 1700#GET /V1/EDID.*
◀ {1700
◀ pr /V1/EDID.EdidStatus=F47:E1;F47:E2
◀ m- /V1/EDID:copy
◀ m- /V1/EDID:delete
◀ m- /V1/EDID:reset
◀ m- /V1/EDID:switch
◀ m- /V1/EDID:switchAll
◀ }
```

**INFO:** The lines of the signature are also Cr and Lf terminated.

### 8.4.9. Subscription

**DEFINITION:** Subscription to a node means that the user will get a notification if a property of the node changes.

A user can subscribe to any node. These notifications are asynchronous messages and are useful to keep the client application up to date, without having to periodically poll the node to detect a changed property. When the user does not want to be informed about the changes anymore, he can simply unsubscribe from the node.

**ATTENTION!** The subscriptions are handled separately for connections. Hence, if the connection is terminated, all registered subscriptions are deleted. After reopening a connection all subscribe commands have to be sent in order to get the notifications of the changes on that connection.

#### Subscribe to a Node

```
▶ OPEN /V1/MEDIA/VIDEO
◀ o- /V1/MEDIA/VIDEO
```

#### Unsubscribe from a Node

```
▶ CLOSE /V1/MEDIA/VIDEO
◀ c- /V1/MEDIA/VIDEO
```

#### Subscribe to Multiple Nodes

```
▶ OPEN /V1/MEDIA/VIDEO/*
◀ o- /V1/MEDIA/VIDEO/*
```

#### Unsubscribe from Multiple Nodes

```
▶ CLOSE /V1/MEDIA/VIDEO/*
◀ c- /V1/MEDIA/VIDEO/*
```

#### Get the Active Subscriptions

```
▶ OPEN
◀ o- /V1/MEDIA/VIDEO
◀ o- /V1/EDID
◀ o- /V1/DISCOVERY
```

### 8.4.10. Notifications about the Changes of the Properties

When the value of a property is changed and the user is subscribed to the that which the property belongs to, an asynchronous notification is generated. This notification is called the 'change message'. The format of such a message is very similar to the response for the GET command:

```
◀ CHG /V1/EDID.EdidStatus=F48:E1
```

#### A Short Example of How to Use the Subscription

There are two independent users controlling the device through two independent connections (**Connection #1** and **Connection #2**). The events in the rows occur after each other.

▶ OPEN /V1/MEDIA/AUDIO/O3 ◀ o- /V1/MEDIA/AUDIO/O3 ▶ GET /V1/MEDIA/AUDIO/O3.VolumePercent ◀ pw /V1/MEDIA/AUDIO/O3.VolumePercent=100.00	connection #1
▶ GET /V1/MEDIA/AUDIO/O3.VolumePercent ◀ pw /V1/MEDIA/AUDIO/O3.VolumePercent=100.00 ▶ SET /V1/MEDIA/AUDIO/O3.VolumePercent=50.00 ◀ pw /V1/MEDIA/AUDIO/O3.VolumePercent=50.00	connection #2
◀ CHG /V1/MEDIA/AUDIO/O3.VolumePercent=50.00	connection #1

The first user (**Connection #1**) set a subscription to a node. Later the other user (**Connection #2**) made a change, and thanks to the subscription, the first user got a notification about the change.



## 8.5. System Commands

### 8.5.1. Setting the Device Label

INFO: The device label can be changed to a custom text in the [TX Status](#) or [RX Status](#) tabs respectively of the LDC software.

**Command and Response** *#devicelabel #label*

- ▶ SET /V1/MANAGEMENT/LABEL.DeviceLabel=<custom\_name>
- ◀ pw /V1/MANAGEMENT/LABEL.DeviceLabel=<custom\_name>

The Device Label can be 49 characters long and ASCII characters are allowed. Longer names are truncated.

#### Example

- ▶ SET /V1/MANAGEMENT/LABEL.DeviceLabel=UCX\_Conference\_room1
- ◀ pw /V1/MANAGEMENT/LABEL.DeviceLabel=UCX\_Conference\_room1

### 8.5.2. Resetting the Device

The device can be restarted – the current connections will be terminated.

INFO: Please use TX or RX after the DEVICES node depending on which device is to be reset.

**Command and Response** *#reboot #restart*

- ▶ CALL /V1/SYS/DEVICES/<TX/RX>:restart()
- ◀ mO /V1/SYS/DEVICES/<TX/RX>:restart=

#### Example

- ▶ CALL /V1/SYS/DEVICES/TX:restart()
- ◀ mO /V1/SYS/DEVICES/TX:restart=

### 8.5.3. Restoring the Factory Default Settings

INFO: Please use TX or RX after the DEVICES node depending on which device is to be restored to factory default settings.

**Command and Response**

- ▶ CALL /V1/SYS/DEVICES/<TX/RX>:factoryDefaults()
- ◀ mO /V1/SYS/DEVICES/<TX/RX>:factoryDefaults=

#### Example

- ▶ CALL /V1/SYS/DEVICES/TX:factoryDefaults()
- ◀ mO /V1/SYS/DEVICES/TX:factoryDefaults=

The device is restarted, current connections are terminated, and the default settings are restored. See the complete list in the [Factory Default Settings](#) section.

*#factory*

### 8.5.4. Querying the Firmware Package Version

**Command and Response** *#firmwareversion*

- ▶ GET /V1/MANAGEMENT/UID/PACKAGE.Version
- ◀ pr /V1/MANAGEMENT/UID/PACKAGE.Version=<firmware\_version>

#### Example

- ▶ GET V1/MANAGEMENT/UID/PACKAGE.Version
- ◀ pr /V1/MANAGEMENT/UID/PACKAGE.Version=1.0.0b2

### 8.5.5. Control Lock

Enable/disable the operation of the front panel buttons.

**Command and Response** *#lockbutton #buttonlock*

- ▶ SET /V1/MANAGEMENT/UI.ControlLock=<lock\_status>
- ◀ pw /V1/MANAGEMENT/UI.ControlLock=<lock\_status>

#### Parameters

Parameter	Parameter description	Values	Value description
<lock_status>	Front panel button locking status	None	All functions of the front panel button are enabled.
		Locked	The front panel buttons are locked and can be unlocked by button combination ( <a href="#">Control Lock</a> ).
		Force locked	The front panel buttons are locked and cannot be unlocked by button combination, only in LDC (on the <a href="#">TX Status</a> tab) or using the LW3 command.

#### Example

- ▶ SET /V1/MANAGEMENT/UI.ControlLock=force locked
- ◀ pw /V1/MANAGEMENT/UI.ControlLock=force locked

### 8.5.6. Setting the Current Time

**Command and Response** *#time*

- ▶ CALL /V1/MANAGEMENT/DATETIME:setTime(<current\_time>)
- ◀ mO /V1/MANAGEMENT/DATETIME:setTime=

#### Parameters

<current\_time>: The new router time in ISO 8601 date time format.

#### Example

- ▶ CALL /V1/MANAGEMENT/DATETIME:setTime(2020-11-01T04:39:54.000Z)
- ◀ mO /V1/MANAGEMENT/DATETIME:setTime=

### 8.5.7. Identifying the Device

Calling the method makes the status LEDs blink for 10 seconds. The feature helps find the device physically.

#### Command and Response *#identifyme*

- ▶ CALL /V1/MANAGEMENT/UI:identifyMe()
- ◀ mO /V1/MANAGEMENT/UI:identifyMe=

#### Example

- ▶ CALL /V1/MANAGEMENT/UI:identifyMe()
- ◀ mO /V1/MANAGEMENT/UI:identifyMe=

### 8.5.8. Toggling the Dark Mode Setting

The LEDs of the device can be switched off if their light could be annoying. In Dark mode, all LEDs are switched off, except for the LEDs of the RJ45 connectors. *#darkmode*

#### Command and Response

- ▶ SET /V1/MANAGEMENT/UI/DARKMODE.Enable=<mode\_state>
- ◀ pw /V1/MANAGEMENT/UI/DARKMODE.Enable=<mode\_state>

#### Parameters

If the <mode\_state> parameter is **true** (or **1**), the Dark mode function is **enabled**, if the parameter is **false** (or **0**), the function is **disabled**.

#### Example

- ▶ SET /V1/MANAGEMENT/UI/DARKMODE.Enable=true
- ◀ pw /V1/MANAGEMENT/UI/DARKMODE.Enable=true

### 8.5.9. Setting the Delay of the Dark Mode Setting

The Dark mode can be enabled right away, or after a certain time. Thus, the mode is enabled if no buttons are pressed for a while. Pressing any button brings back the status info on the LEDs without performing the function of the button itself. The delay time can be set by this command.

#### Command and Response

- ▶ SET /V1/MANAGEMENT/UI/DARKMODE.Delay=<delay\_time>
- ◀ pw /V1/MANAGEMENT/UI/DARKMODE.Delay=<delay\_time>

#### Parameters

The <delay\_time> parameter means seconds, and the default value is 60. If set to 0, no delay is applied, and the Dark mode can be enabled immediately by the **DarkModeEnable** property. This delay affects the **wakeFromDarkMode** method as well.

#### Example

- ▶ SET /V1/MANAGEMENT/UI/DARKMODE.Delay=10
- ◀ pw /V1/MANAGEMENT/UI/DARKMODE.Delay=10

## 8.6. Video Port Settings - General

### 8.6.1. Switching Video Input

#### Command and Response

- ▶ CALL /V1/MEDIA/VIDEO/XP:switch(<in>:<out>)
- ◀ mO /V1/MEDIA/VIDEO/XP:switch=

#### Example

- ▶ CALL /V1/MEDIA/VIDEO/XP:switch(I5:O1)
- ◀ mO /V1/MEDIA/VIDEO/XP:switch=

INFO: When using the '0' value as an input, the input will be disconnected and no signal will appear on the output.

**ATTENTION!** Video crosspoint has a limitation: I1 and I5 ports are not available at the same time, only one of them can be selected to any output. When one of the outputs is switched to I1 or I5, the other output can not be switched to I1 or I5. In this case the switch command returns an error message.

#### Example

- ▶ GET /V1/MEDIA/VIDEO/XP/O1.ConnectedSource
- ◀ pw /V1/MEDIA/VIDEO/XP/O1.ConnectedSource=I5
- ▶ GET /V1/MEDIA/VIDEO/XP/O2.ConnectedSource
- ◀ pw /V1/MEDIA/VIDEO/XP/O2.ConnectedSource=I5
- ▶ CALL /V1/MEDIA/VIDEO/XP:switch(I1:O1)
- ◀ mE /V1/MEDIA/VIDEO/XP:switch %E006: Illegal operation

### 8.6.2. Switching an Input to All Outputs

#### Command and Response

- ▶ CALL /V1/MEDIA/VIDEO/XP:switchAll(<input>)
- ◀ mO /V1/MEDIA/VIDEO/XP:switchAll=

#### Example

- ▶ CALL /V1/MEDIA/VIDEO/XP:switchAll(I1)
- ◀ mO /V1/MEDIA/VIDEO/XP:switchAll=

### 8.6.3. Locking the Video Port

#### Command and Response

- ▶ SET /V1/MEDIA/VIDEO/XP/<port>.Lock=<locked\_state>
- ◀ pw /V1/MEDIA/VIDEO/XP/<port>.Lock=<locked\_state>

#### Parameters

Parameter	Parameter description	Values	Value description
<locked_state>	Locked state	true	The port is locked
		false	The port is unlocked

#### Example

- ▶ SET /V1/MEDIA/VIDEO/XP/I2.Lock=false
- ◀ pw /V1/MEDIA/VIDEO/XP/I2.Lock=false

### 8.6.4. Muting the Video Port

#### Command and Response

- ▶ SET /V1/MEDIA/VIDEO/XP/<port>.Mute=<muted\_state>
- ◀ pw /V1/MEDIA/VIDEO/XP/<port>.Mute=<muted\_state>

#### Parameters

Parameter	Parameter description	Values	Value description
<muted_state>	Muted state	true	The port is locked.
		false	The port is unlocked.

#### Example

- ▶ SET /V1/MEDIA/VIDEO/XP/I2.Mute=false
- ◀ pw /V1/MEDIA/VIDEO/XP/I2.Mute=false

### 8.6.5. Setting the Autoselect Policy

#### Command and Response

- ▶ SET /V1/MEDIA/VIDEO/AUTOSELECT/<out>.Policy=<autoselect\_mode>
- ◀ pw /V1/MEDIA/VIDEO/AUTOSELECT/<out>.Policy=<autoselect\_mode>

#### Parameters

Parameter	Parameter description	Values	Value description
<autoselect_mode>	The autoselect policy	Off	The autoselect function is disabled.
		Last Detect	It is always the last attached input that is automatically switched to the output..
		First Detect	The first active video input is selected.

#### Example

- ▶ SET /V1/MEDIA/VIDEO/AUTOSELECT/O2.Policy=First detect
- ◀ pw /V1/MEDIA/VIDEO/AUTOSELECT/O2.Policy=First detect

### 8.6.6. Changing the Autoselect Included Input Ports

#### Command and Response

- ▶ SET /V1/MEDIA/VIDEO/AUTOSELECT/<out>/<in>.Included=<state>
- ◀ pw /V1/MEDIA/VIDEO/AUTOSELECT/<out>/<in>.Included=<state>

#### Parameters

Parameter	Parameter description	Values	Value description
<state>	The chosen input is ignored in the autoselect process or not.	true	The port is included in autoselect.
		false	The autoselect function ignores that port.

#### Example

- ▶ SET /V1/MEDIA/VIDEO/AUTOSELECT/O2/I1.Included=false
- ◀ pw /V1/MEDIA/VIDEO/AUTOSELECT/O2/I1.Included=false

### 8.6.7. Changing the Input Port Priority

#### Command and Response

- ▶ SET /V1/MEDIA/VIDEO/AUTOSELECT/<out>/<in>.Priority=<prio\_num>
- ◀ pw /V1/MEDIA/VIDEO/AUTOSELECT/<out>/<in>.Priority=<prio\_num>

#### Parameters

The <prio> parameter means the priority number from 1 to 100, equal numbers are allowed. Inputs can have different priorities in relation to two or more outputs. Therefore, the output port number is part of the node path of input port priorities.

#### Example

- ▶ SET /V1/MEDIA/VIDEO/AUTOSELECT/O2/I2.Priority=51
- ◀ pw /V1/MEDIA/VIDEO/AUTOSELECT/O2/I2.Priority=51

### 8.6.8. Querying the Connected Source

#### Command and Response

- ▶ GET /V1/MEDIA/VIDEO/XP/<out>.ConnectedSource
- ◀ pw /V1/MEDIA/VIDEO/XP/<out>.ConnectedSource=<in>

#### Example

- ▶ GET /V1/MEDIA/VIDEO/XP/O3.ConnectedSource
- ◀ pw /V1/MEDIA/VIDEO/XP/O3.ConnectedSource=I2

### 8.6.9. Querying the Input Switching Capability

Video crosspoint has a limitation: I1 or I5 ports can not be selected to any output at the same time. **Busy** value of the switchable property refers to the limitation.

#### Command and Response

- ▶ GET /V1/MEDIA/VIDEO/XP/<out>/SWITCHABLE.<in>
- ◀ pr /V1/MEDIA/VIDEO/XP/<out>/SWITCHABLE.<in>=<switchable\_state>

#### Parameters

Parameter	Parameter description	Values	Value description
<switchable_state>	The chosen input can be switched to the output or not.	OK	The connection of the chosen input and output is allowed.
		Busy	The chosen input can not be switched to the output.

#### Example

- ▶ GET /V1/MEDIA/VIDEO/XP/O2/SWITCHABLE.I1
- ◀ pr /V1/MEDIA/VIDEO/XP/O2/SWITCHABLE.I1=Busy

### 8.6.10. Querying the Connected Destinations

#### Command and Response

- ▶ GET /V1/MEDIA/VIDEO/XP/<n>.ConnectedDestinations
- ◀ pr /V1/MEDIA/AUDIO/XP/<in>.ConnectedDestinations=<out>

#### Example

- ▶ GET /V1/MEDIA/VIDEO/XP/I3.ConnectedDestinations
- ◀ pr /V1/MEDIA/VIDEO/XP/I3.ConnectedDestinations=O1;O2

### 8.6.11. Querying the Video Signal Presence

#### Command and Response

- ▶ GET /V1/MEDIA/VIDEO/<port>.SignalPresent
- ◀ pr /V1/MEDIA/VIDEO/<port>.SignalPresent=<state>

#### Parameters

Parameter	Parameter description	Values	Value description
<state>	This property gives a feedback about the current signal presence of the port.	true	The video signal is present.
		false	The video signal is not present.

#### Example

- ▶ GET /V1/MEDIA/VIDEO/I1.SignalPresent
- ◀ pr /V1/MEDIA/VIDEO/I1.SignalPresent=false

### 8.6.12. HDCP Setting (Input Port)

HDCP capability can be set on the input ports, thus non-encrypted content can be seen on a non-HDCP compliant display. See more information in the [HDCP Management](#) section.

**ATTENTION!** HDCP 2.2 signal handling is limited to up to two input ports at the same time.

#### Command and Response #hdcp

- ▶ SET /V1/MEDIA/VIDEO/<in>/HDCP.AllowedHdcpVersion=<allowed\_hdcp>
- ◀ pw /V1/MEDIA/VIDEO/<in>/HDCP.AllowedHdcpVersion=<allowed\_hdcp>

#### Parameters

Parameter	Parameter description	Values	Value description
<allowed_hdcp>	The input port reports the HDCP capability.	HDCP 1.4	The input port reports HDCP 1.4 capability.
		HDCP 2.2	The input port reports HDCP 2.2 capability.
		Off	The input port reports non-HDCP compliance.

#### Example

- ▶ SET /V1/MEDIA/VIDEO/I1/HDCP.AllowedHdcpVersion=HDCP 1.4
- ◀ pw /V1/MEDIA/VIDEO/I1/HDCP.AllowedHdcpVersion=HDCP 1.4

### 8.6.13. HdcpMode

HDCP capability can be set to Auto/Always on the output ports, thus non-encrypted content can be transmitted to a non-HDCP compliant display. See more information in the [HDCP Management](#) section.

#### Command and Response *#hdcp*

- ▶ SET /V1/MEDIA/VIDEO/<out>.HdcpMode=<hdcp\_mode>
- ◀ pw /V1/MEDIA/VIDEO/<out>.HdcpMode=<hdcp\_mode>

#### Parameters

Parameter	Parameter description	Values	Value description
<hdcp_mode>	HDCP encryption setting on the output port	Auto	The encryption is enabled on the output port if the signal on the input port is encrypted.
		Always	The outgoing signal is HDCP-encrypted.

#### Example

- ▶ SET /V1/MEDIA/VIDEO/O1/HDCP.HdcpMode=Auto
- ◀ pw /V1/MEDIA/VIDEO/O1/HDCP.HdcpMode=Auto

### 8.6.14. OutputSignalType

#### Command and Response *#signaltype*

- ▶ SET /V1/MEDIA/VIDEO/<out>.OutputSignalType=<signal\_type>
- ◀ pw /V1/MEDIA/VIDEO/<out>.OutputSignalType=<signal\_type>

#### Parameters

Parameter	Parameter description	Values	Value description
<signal_type>	Signal type setting	Auto	The outgoing signal type is HDMI.
		DVI	The outgoing signal type is DVI.

#### Example

- ▶ SET /V1/MEDIA/VIDEO/O1.OutputSignalType=Auto
- ◀ pw /V1/MEDIA/VIDEO/O1.OutputSignalType=Auto

### 8.6.15. EmbeddedAudioPresent

- ▶ GET /V1/MEDIA/VIDEO/<port>.EmbeddedAudioPresent
- ◀ pr /V1/MEDIA/VIDEO/<port>.EmbeddedAudioPresent=<embedded\_state>

#### Parameters

Parameter	Parameter description	Values	Value description
<embedded_state>	It shows if the video contains audio or not.	true	There is embedded audio in the video signal.
		false	There is no embedded audio in the video signal.

#### Example

- ▶ GET /V1/MEDIA/VIDEO/I2.EmbeddedAudioPresent
- ◀ pr /V1/MEDIA/VIDEO/I2.EmbeddedAudioPresent=false

### 8.6.16. EmbeddedAudioMute

- ▶ SET /V1/MEDIA/VIDEO/<port>.EmbeddedAudioMute=<mute\_state>
- ◀ pw /V1/MEDIA/VIDEO/<port>.EmbeddedAudioMute=<mute\_state>

#### Parameters

Parameter	Parameter description	Values	Value description
<mute_state>	It shows if the embedded audio is muted or not.	true	The embedded audio is muted.
		false	The embedded audio is unmuted.

#### Example

- ▶ SET /V1/MEDIA/VIDEO/O1.EmbeddedAudioMute=false
- ◀ pw /V1/MEDIA/VIDEO/O1.EmbeddedAudioMute=false

### 8.6.17. Output5VMode

The 5V power towards the sink can be enabled or disabled as follows:

#### Command and Response

- ▶ SET /V1/MEDIA/VIDEO/<out>.Output5VMode=<5V\_pwr>
- ◀ pw /V1/MEDIA/VIDEO/<out>.Output5VMode=<5V\_pwr>

#### Parameters

Parameter	Parameter description	Value	Value description
<5V_pwr>	5V power towards the sink	On	Enable 5V power on HDMI port
		Off	Disable 5V power on HDMI port

#### Example

- ▶ SET /V1/MEDIA/VIDEO/O1.Output5VMode=On
- ◀ pw /V1/MEDIA/VIDEO/O1.Output5VMode=On

### 8.6.18. HDCP Capability (Output Port)

HDCP capability of the connected sink device can be queried at each output port. See more information in the [HDCP Management](#) section.

#### Command and Response #hdcp

- ▶ GET:/V1/MEDIA/VIDEO/<out>/HDCP/SinkMaxHdcpVersion=<hdcp\_ver>
- ◀ pr:/V1/MEDIA/VIDEO/<out>/HDCP/SinkMaxHdcpVersion=<hdcp\_ver>

#### Parameters

Parameter	Parameter description	Values	Value description
<hdcp_ver>	The HDCP capability is reported from the sink.	N/A	Sink is not connected or the HDCP-capability cannot be determined.
		None	The connected sink is non-HDCP compliant.
		HDCP 1.4	The connected sink supports HDCP 1.4 capability.
		HDCP 2.2	The connected sink supports HDCP 2.2 capability.

#### Example

- ▶ GET /V1/MEDIA/VIDEO/O1/HDCP/SinkMaxHdcpVersion=HDCP 1.4
- ◀ pr /V1/MEDIA/VIDEO/O1/HDCP/SinkMaxHdcpVersion=HDCP 1.4

### 8.6.19. HDCP Setting (Output Port)

The maximum allowed HDCP encryption can be queried at each output port. See more information in the [HDCP Management](#) section.

**ATTENTION!** HDCP 2.2 signal handling is limited when 3 outputs are available: O1 and O2 ports support up to HDCP v2.2, O3 port supports HDCP v1.4.

#### Command and Response #hdcp

- ▶ GET:/V1/MEDIA/VIDEO/<out>/HDCP.AllowedHdcpVersion=<allowed\_hdcp>
- ◀ pr:/V1/MEDIA/VIDEO/<out>/HDCP.AllowedHdcpVersion=<allowed\_hdcp>

#### Parameters

Parameter	Parameter description	Values	Value description
<allowed_hdcp>	The maximum allowed HDCP encryption on the output port	HDCP 1.4	HDCP 1.4 is supported.
		HDCP 2.2	HDCP 2.2 and HDCP 1.4 are supported.

#### Example

- ▶ GET /V1/MEDIA/VIDEO/O1/HDCP/AllowedHdcpVersion=HDCP 1.4
- ◀ pr /V1/MEDIA/VIDEO/O1/HDCP/AllowedHdcpVersion=HDCP 1.4

## 8.7. Welcome Screen Settings

**DIFFERENCE:** These commands are not available in HDMI-UCX-TPX-RX107.

For details about the Welcome screen feature, please see the [Welcome Screen](#) section.

### 8.7.1. Displaying the Welcome Screen Image

#### Command and Response #welcomescreen

- ▶ SET:/V1/MEDIA/VIDEO/I5/WELCOMESCREEN.ImageEnabled=<image\_state>
- ◀ pw:/V1/MEDIA/VIDEO/I5/WELCOMESCREEN.ImageEnabled=<image\_state>

#### Parameters

Parameter	Values	Value description
<image_state>	true	The welcome screen image is displayed.
	false	The welcome screen image is not displayed.

#### Example

- ▶ SET /V1/MEDIA/VIDEO/I5/WELCOMESCREEN.ImageEnabled=true
- ◀ pw /V1/MEDIA/VIDEO/I5/WELCOMESCREEN.ImageEnabled=true

### 8.7.2. Displaying the Welcome Screen Text

#### Command and Response

- ▶ SET:/V1/MEDIA/VIDEO/I5/WELCOMESCREEN.MessageEnabled=<text\_state>
- ◀ pw:/V1/MEDIA/VIDEO/I5/WELCOMESCREEN.MessageEnabled=<text\_state>

#### Parameters

Parameter	Values	Value description
<text_state>	true	The welcome screen text is displayed.
	false	The welcome screen text is not displayed.

#### Example

- ▶ SET /V1/MEDIA/VIDEO/I5/WELCOMESCREEN.MessageEnabled=false
- ◀ pw /V1/MEDIA/VIDEO/I5/WELCOMESCREEN.MessageEnabled=false

### 8.7.3. Setting the Welcome Screen Text

#### Command and Response

- ▶ SET /V1/MEDIA/VIDEO/I5/WELCOMESCREEN.MessageText=<text>
- ◀ pw /V1/MEDIA/VIDEO/I5/WELCOMESCREEN.MessageText=<text>

#### Parameters

The <text> may consist of letters (A-Z) and (a-z), hyphen (-), underscore (\_), numbers (0-9), space ( ) and dot (.). Max length: 63 characters. Longer names are truncated.

#### Example

- ▶ SET /V1/MEDIA/VIDEO/I5/WELCOMESCREEN.MessageText=info
- ◀ pw /V1/MEDIA/VIDEO/I5/WELCOMESCREEN.MessageText=info

### 8.7.4. Resetting the Welcome Screen Image

This command restores the original welcome screen image.

#### Command and Response

- ▶ CALL /V1/MEDIA/VIDEO/I5/WELCOMESCREEN:resetImage()
- ◀ mO /V1/MEDIA/VIDEO/I5/WELCOMESCREEN:resetImage=

#### Example

- ▶ CALL /V1/MEDIA/VIDEO/I5/WELCOMESCREEN:resetImage()
- ◀ mO /V1/MEDIA/VIDEO/I5/WELCOMESCREEN:resetImage=

## 8.8. Video Port Settings - USB-C Related Commands

### 8.8.1. Restarting the Link Training

This method is equal to pulling the USB-C connector out and plugging it in again.

#### Command and Response *#linktraining*

- ▶ CALL /V1/MEDIA/VIDEO/<in>/DP:restartLinkTraining()
- ◀ mO /V1/MEDIA/VIDEO/<in>/DP:restartLinkTraining=

#### Example

- ▶ CALL /V1/MEDIA/VIDEO/I1/DP:restartLinkTraining()
- ◀ mO /V1/MEDIA/VIDEO/I1/DP:restartLinkTraining=

## 8.9. CEC Command Sending

The device is able to send Consumer Electronics Control (CEC) commands. This feature is for remote controlling the source or sink device. CEC is a bi-directional communication via the HDMI cable.

**ATTENTION!** To have a successful CEC command processing, the connected HDMI device must support CEC. `#cec`

### 8.9.1. Simple CEC Code Sending

This command is for sending simple CEC commands to the connected sink device.

The commands can be sent by the following two formats – defined in the header:

- **text/plain:** hexa strings (as seen in the example)
- **application/octet-stream:** binary data that allows sending a file with the desired codes

#### Command and Response

- ▶ `CALL /V1/MEDIA/VIDEO/<out>/CEC:send(<command>)`
- ◀ `mO /V1/MEDIA/VIDEO/<out>/CEC:send=OK`

#### Parameters

Parameter	Parameter description	Values	Value description
<port>	Video output port	<b>01-02-03</b>	Video output port number
<command> *	Two-digit-long hexa code to control the sink device	<b>446D</b>	Power on
		<b>446C</b>	Power off
		<b>36</b>	Standby
		<b>446901</b>	Select input 1
		<b>446902</b>	Select input 2
		<b>446903</b>	Select input 3

\* The supported list of <commands> depends on the connected sink device.

INFO: For the full list of commands supported by the UCX-TPX transmitter, please see the next page.

#### Example

- ▶ `CALL /V1/MEDIA/VIDEO/02/CEC:send(446D)`
- ◀ `mO /V1/MEDIA/VIDEO/02/CEC:send=OK`

### 8.9.2. Remote Control Code Sending

This command is for sending the so-called 'push-button-commands'. There is a range within the CEC commands for this purpose, e.g. volume up/down. With this method one <command> is put between the 0x44 and 0x45 opcodes in the background.

#### Request and Response

- ▶ `CALL /V1/MEDIA/VIDEO/<port>/CEC:sendUserControlClick(<command>)`
- ◀ `mO /V1/MEDIA/VIDEO/<port>/CEC:sendUserControlClick=OK`

#### Parameters

Parameter	Parameter description	Values	Value description
<port>	Video output port	<b>01-02-03</b>	Video output port number
<command> *	A hexa code to control the sink device	<b>446D</b>	Power on
		<b>446C</b>	Power off

\* The supported list of <commands> depends on the connected sink device.

INFO: For the full list of commands supported by the UCX-TPX transmitter, please see the next page.

#### Example

- ▶ `CALL /V1/MEDIA/VIDEO/02/CEC:sendUserControlClick(446D)`
- ◀ `mO /V1/MEDIA/VIDEO/02/CEC:sendUserControlClick=OK`



## Command List

Command	Hexa	Binary
Ok	4400	0100010000000000
Up	4401	0100010000000001
Down	4402	0100010000000010
Left	4403	0100010000000011
Right	4404	0100010000000100
Root menu	4409	0100010000001001
Setup menu	440A	0100010000001010
Contents menu	440B	0100010000001011
Favorite menu	440C	0100010000001100
Back	440D	0100010000001101
Media top menu	4410	0100010000010000
Media context menu	4411	0100010000010001
Number 0	4420	0100010000100000
Number 1	4421	0100010000100001
Number 2	4422	0100010000100010
Number 3	4423	0100010000100011
Number 4	4424	0100010000100100
Number 5	4425	0100010000100101
Number 6	4426	0100010000100110
Number 7	4427	0100010000100111
Number 8	4428	0100010000101000
Number 9	4429	0100010000101001
Dot	442A	0100010000101010
Enter	442B	0100010000101011
Clear	442C	0100010000101100
Channel up	4430	0100010000000000
Channel down	4431	0100010000110001
Sound select	4433	0100010000110011
Input select	4434	0100010000110100
Display info	4435	0100010000110101
Page up	4437	0100010000110111
Page down	4438	0100010000111000
Power legacy	4440	0100010001000000
Volume up	4441	0100010001000001
Volume down	4442	0100010001000010
Mute toggle	4443	0100010001000011
Play	4444	0100010001000100
Stop	4445	0100010001000101
Pause	4446	0100010001000110

Command	Hexa	Binary
Record	4447	0100010001000111
Rewind	4448	0100010001001000
Fast forward	4449	0100010001001001
Eject	444A	0100010001001010
Skip forward	444B	0100010001001011
Skip backward	444C	0100010001001100
3D mode	445A	0100010001011010
Stop record	444D	0100010001001101
Play forward	446024	010001000110000000100100
Play reverse	446020	010001000110000000100000
Stop function	4464	0100010001100100
Mute	4465	0100010001100101
Unmute	4466	0100010001100110
Select next media	446800	010001000110100000000000
Select media 1	446801	010001000110100000000001
Select media 2	446802	010001000110100000000010
Select media 3	446803	010001000110100000000011
Select media 4	446804	010001000110100000000100
Select media 5	446805	010001000110100000000101
Select next input	446900	010001000110100100000000
Select input 1	446901	010001000110100100000001
Select input 2	446902	010001000110100100000010
Select input 3	446903	010001000110100100000011
Select input 4	446904	010001000110100100000100
Select input 5	446905	010001000110100100000101
Power toggle	446B	0100010001101011
Power on	446D	0100010001101101
Power off	446C	0100010001101100
Standby	36	00110110
Image view on	04	00000100
Text view on	0D	00001101
F1	4471	0100010001110001
F2	4472	0100010001110010
F3	4473	0100010001110011
F4	4474	0100010001110100
Clear OSD	6480	0110010010000000
Get CEC version	9F	10011111

## 8.10. Audio Port Settings

INFO: Audio port numbers may differ depending on the model. For more information, see the [Port Numbering](#) section.

### 8.10.1. Switching the Audio Input

#### Command and Response

- ▶ `CALL /V1/MEDIA/AUDIO/XP:switch(<audio_in>:03)`
- ◀ `mO /V1/MEDIA/AUDIO/XP:switch=`

#### Parameters

Parameter	Parameter description	Values	Value description
<audio_in>	Audio input port	I1-I4	Audio input port number

#### Example

- ▶ `CALL /V1/MEDIA/AUDIO/XP:switch(I2:03)`
- ◀ `mO /V1/MEDIA/AUDIO/XP:switch=`

INFO: When using the '0' value as an input, the input will be disconnected and no signal will appear on the output.

**ATTENTION!** When I5 is selected for video source, the de-embedded audio of the I1 is not available, because the video crosspoint has a limitation: I1 and I5 ports are not available at the same time, only one of them can be selected to any output. For more details about it, see the port diagram in the [Audio Interface](#) section.

### 8.10.2. Querying the Connected Source

#### Command and Response

- ▶ `GET /V1/MEDIA/AUDIO/XP/03.ConnectedSource`
- ◀ `pw /V1/MEDIA/AUDIO/XP/03.ConnectedSource=<audio_in>`

#### Parameters

Parameter	Parameter description	Values	Value description
<audio_in>	Audio input port	I1-I4	Audio input port number

#### Example

- ▶ `GET /V1/MEDIA/AUDIO/XP/03.ConnectedSource`
- ◀ `pw /V1/MEDIA/AUDIO/XP/03.ConnectedSource=I2`

### 8.10.3. Querying the Connected Destinations

#### Command and Response

- ▶ `GET /V1/MEDIA/AUDIO/XP/<audio_in>.ConnectedDestinations`
- ◀ `pr /V1/MEDIA/AUDIO/XP/<audio_in>.ConnectedDestinations=`

#### Parameters

Parameter	Parameter description	Values	Value description
<audio_in>	Audio input port	I1-I4	Audio input port number

#### Example

- ▶ `GET /V1/MEDIA/AUDIO/XP/I3.ConnectedDestinations`
- ◀ `pr /V1/MEDIA/AUDIO/XP/I3.ConnectedDestinations=`

### 8.10.4. Setting the Autoselect Operation Mode

#### Command and Response

- ▶ `SET /V1/MEDIA/AUDIO/AUTOSELECT/03.Policy=<op_mode>`
- ◀ `pw /V1/MEDIA/AUDIO/AUTOSELECT/03.Policy=<op_mode>`

#### Parameters

Parameter	Parameter description	Values	Value description
<op_mode>	Operation mode	Follow video	Follows the video crosspoint state automatically.
		Off	Autoselect function is disabled.

#### Example

- ▶ `SET /V1/MEDIA/AUDIO/AUTOSELECT/03.Policy=Follow video`
- ◀ `pw /V1/MEDIA/AUDIO/AUTOSELECT/03.Policy=Follow video`

### 8.10.5. Setting the Followed Video Port to Autoselect

#### Command and Response

- ▶ `SET /V1/MEDIA/AUDIO/AUTOSELECT/03.VideoFollowPort=<out>`
- ◀ `pw /V1/MEDIA/AUDIO/AUTOSELECT/03.VideoFollowPort=<out>`

#### Example

- ▶ `SET /V1/MEDIA/AUDIO/AUTOSELECT/03.VideoFollowPort=01`
- ◀ `pw /V1/MEDIA/AUDIO/AUTOSELECT/03.VideoFollowPort=01`

### 8.10.6. Locking the Audio Port

#### Command and Response

- ▶ SET /V1/MEDIA/AUDIO/XP/<audio\_port>.Lock=<locked\_state>
- ◀ pw /V1/MEDIA/AUDIO/XP/<audio\_port>.Lock=<locked\_state>

#### Parameters

Parameter	Parameter description	Values	Value description
<audio_port>	Audio Port	I1-I4	Audio input port number
		O4	Audio output port number
<locked_state>	Locked state	true	The port is locked
		false	The port is unlocked

#### Example

- ▶ SET /V1/MEDIA/AUDIO/XP/I2.Lock=false
- ◀ pw /V1/MEDIA/AUDIO/XP/I2.Lock=false

### 8.10.7. Muting the Audio Port 1.

INFO: Suspends the connection of the chosen port (no signal is forwarded).

#### Command and Response

- ▶ SET /V1/MEDIA/AUDIO/XP/<audio\_port>.Mute=<muted\_state>
- ◀ pw /V1/MEDIA/AUDIO/XP/<audio\_port>.Mute=<muted\_state>

#### Parameters

Parameter	Parameter description	Values	Value description
<audio_port>	Audio Port	I1-I4	Audio input port number
		O4	Audio output port number
<muted_state>	Muted state	true	The port is muted.
		false	The port is unmuted.

#### Example

- ▶ SET /V1/MEDIA/AUDIO/XP/I2.Mute=false
- ◀ pw /V1/MEDIA/AUDIO/XP/I2.Mute=false

INFO: All inputs and analog output ports have a mute property in the audio XP (e.g. /V1/MEDIA/AUDIO/XP/I1.Mute). Outputs have a separate mute function within the port node as well:

- /V1/MEDIA/VIDEO/XP/O1.EmbeddedAudioMute
- /V1/MEDIA/VIDEO/XP/O2.EmbeddedAudioMute
- /V1/MEDIA/AUDIO/O3.Mute

### 8.10.8. Muting the Audio Port 2.

INFO: The volume of the analog audio output is set to low.

#### Command and Response

- ▶ SET /V1/MEDIA/AUDIO/O4.Mute=<muted\_state>
- ◀ pw /V1/MEDIA/AUDIO/O4.Mute=<muted\_state>

#### Parameters

Parameter	Parameter description	Values	Value description
<audio_port>	Audio Port	I1-I4	Audio input port number
		O4	Audio output port number
<muted_state>	Muted state	true	The port is muted.
		false	The port is unmuted.

#### Example

- ▶ SET /V1/MEDIA/AUDIO/O4.Mute=true
- ◀ pw /V1/MEDIA/AUDIO/O4.Mute=true

### 8.10.9. Querying the Audio Signal Presence

#### Command and Response

- ▶ GET /V1/MEDIA/AUDIO/<audio\_port>.SignalPresent
- ◀ pr /V1/MEDIA/AUDIO/<audio\_port>.SignalPresent=<signal\_state>

#### Parameters

Parameter	Parameter description	Values	Value description
<audio_port>	Audio Port	I1-I4	Audio input port number
		O4	Audio output port number
<signal_state>	Signal presence	true	The audio signal is present.
		false	No audio signal is present.

#### Example

- ▶ GET /V1/MEDIA/AUDIO/I1.SignalPresent
- ◀ pr /V1/MEDIA/AUDIO/I1.SignalPresent=false

### 8.10.10. Analog Audio Output Volume (dB) Setting

**Command and Response** *#analogaudio #volume*

- ▶ SET·/V1/MEDIA/AUDIO/<analog\_audio\_port>.VolumedB=<level>
- ◀ pw·/V1/MEDIA/AUDIO/<analog\_audio\_port>.VolumedB=<level>

#### Parameter

The <level> parameter sets the output volume (attenuation) between -95.62 dB and 0 dB in step of -0.375 dB. The value is rounded up if necessary, to match with the step value.

#### Example

- ▶ SET /V1/MEDIA/AUDIO/O5.VolumedB=-15
- ◀ pw /V1/MEDIA/AUDIO/O5.VolumedB=-15.00

### 8.10.11. Analog Audio Output Volume Percent Setting

**Command and Response**

- ▶ SET·/V1/MEDIA/AUDIO/<analog\_audio\_port>.VolumePercent=<percent>
- ◀ pw·/V1/MEDIA/AUDIO/<analog\_audio\_port>.VolumePercent=<percent>

#### Parameters

The <percent> parameter sets the output volume (attenuation) between 100% and 0%, in step of 1%. The value is rounded up if necessary, to match with the step value.

#### Example

- ▶ SET /V1/MEDIA/AUDIO/O5.VolumePercent=50
- ◀ pw /V1/MEDIA/AUDIO/O5.VolumePercent=50.00

### 8.10.12. Setting the Balance

**Command and Response** *#balance*

- ▶ SET·/V1/MEDIA/AUDIO/<analog\_audio\_port>.Balance=<level>
- ◀ pw·/V1/MEDIA/AUDIO/<analog\_audio\_port>.Balance=<level>

#### Parameters

The <level> parameter sets the balance; -100 means left balance, 100 means right balance, step is 1. Center is 0 (default).

#### Example

- ▶ SET /V1/MEDIA/AUDIO/O5.Balance=0
- ◀ pw /V1/MEDIA/AUDIO/O5.Balance=0

### 8.10.13. Analog Audio Output Level Setting by Steps (dB)

**Command and Response** *#analogaudio #volume*

- ▶ CALL·/V1/MEDIA/AUDIO/<analog\_audio\_port>.stepVolumedB(<step>)
- ◀ m0·/V1/MEDIA/AUDIO/<analog\_audio\_port>.stepVolumedB=

#### Parameters

The volume is increased or decreased with the given <step> value in dB.

#### Example

- ▶ CALL /V1/MEDIA/AUDIO/O5.stepVolumedB(-1)
- ◀ m0 /V1/MEDIA/AUDIO/O5.stepVolumedB=

The volume is decreased with 1 dB, the current volume is -1.95 dB, which means 77.84% in percent.

### 8.10.14. Analog Audio Output Level Setting by Steps in Percent

**Command and Response**

- ▶ CALL·/V1/MEDIA/AUDIO/<analog\_audio\_port>.stepVolumePercent(<step>)
- ◀ m0·/V1/MEDIA/AUDIO/<analog\_audio\_port>.stepVolumePercent=

#### Parameters

The volume is increased or decreased by the given <step> value in percent.

#### Example

- ▶ CALL /V1/MEDIA/AUDIO/O5.stepVolumePercent(5)
- ◀ m0 /V1/MEDIA/AUDIO/O5.stepVolumePercent=

The volume is increased with 5%, the current volume is -1.52 dB, which means 82.84% in percent.

### 8.10.15. Analog Audio Output Balance Setting by Steps

**Command and Response**

- ▶ CALL·/V1/MEDIA/AUDIO/<analog\_audio\_port>.stepBalance(<step>)
- ◀ m0·/V1/MEDIA/AUDIO/<analog\_audio\_port>.stepBalance=

#### Parameters

The volume is increased or decreased by the given <step> value.

#### Example

- ▶ CALL /V1/MEDIA/AUDIO/O5.stepBalance(-5)
- ◀ m0 /V1/MEDIA/AUDIO/O5.stepBalance=

## 8.11. USB Port Settings

INFO: USB port numbers may differ depending on the model. For more information, see the [Port Numbering](#) section.

### 8.11.1. Switching the USB Input

#### Command and Response *#usb*

- ▶ `CALL /V1/MEDIA/USB/XP:switch(<host>:H1)`
- ◀ `mO /V1/MEDIA/USB/XP:switch=`

#### Parameters

Parameter	Parameter description	Values	Value description
<host>	USB Host	0	disconnected
		U1-U4	USB-C and USB-B port number

#### Example

- ▶ `CALL /V1/MEDIA/USB/XP:switch(U1:H1)`
- ◀ `mO /V1/MEDIA/USB/XP:switch=`

INFO: When using the '0' value as an input, the input will be disconnected and no signal will appear on the output.

### 8.11.2. Querying the Connected Source

#### Command and Response

- ▶ `GET /V1/MEDIA/USB/XP/H1.ConnectedSource`
- ◀ `pw /V1/MEDIA/USB/XP/H1.ConnectedSource=<host>`

#### Parameters

Parameter	Parameter description	Values	Value description
<host>	USB Host	U1-U4	USB-C and USB-B port number

#### Example

- ▶ `GET /V1/MEDIA/USB/XP/H1.ConnectedSource`
- ◀ `pw /V1/MEDIA/USB/XP/H1.ConnectedSource=U4`

### 8.11.3. Querying the Connected Destinations

#### Command and Response *#autoselect*

- ▶ `GET /V1/MEDIA/USB/XP/<host>.ConnectedDestinations`
- ◀ `pr /V1/MEDIA/USB/XP/<host>.ConnectedDestinations=H1`

#### Parameters

Parameter	Parameter description	Values	Value description
<host>	USB Host	U1-U4	USB-C and USB-B port number

#### Example

- ▶ `GET /V1/MEDIA/USB/XP/U3.ConnectedDestinations`
- ◀ `pr /V1/MEDIA/USB/XP/U3.ConnectedDestinations=H1`

### 8.11.4. Locking the USB Port

#### Command and Response *#lock*

- ▶ `SET /V1/MEDIA/USB/XP/<usb_port>.Lock=<locked_state>`
- ◀ `pw /V1/MEDIA/USB/XP/<usb_port>.Lock=<locked_state>`

#### Parameters

Parameter	Parameter description	Values	Value description
<usb_port>	USB Port	U1-U4	USB-C and USB-B port number
		H1	USB hub
<locked_state>	Locked state	true	The port is locked
		false	The port is unlocked

#### Example

- ▶ `SET /V1/MEDIA/USB/XP/U2.Lock=false`
- ◀ `pw /V1/MEDIA/USB/XP/U2.Lock=false`

### 8.11.5. Setting the 5V Sending to the USB Peripherals

The 5V power towards the USB A-type ports can be enabled or disabled as follows:

#### Command and Response

- ▶ SET·/V1/MEDIA/USB/H1/<device\_id>.Power5VMode=<device\_pwr>
- ◀ pw·/V1/MEDIA/USB/H1/<device\_id>.Power5VMode=<device\_pwr>

#### Parameters

Parameter	Parameter description	Values	Value description
<device_id>	USB A-type port	<b>D1-D4</b>	Downstream port number
<device_pwr>		<b>Auto</b>	The host controls the 5V power sending.
		<b>Off</b>	Disable 5V power on USB downstream port

#### Example

- ▶ SET /V1/MEDIA/USB/H1/D1.Power5VMode=Auto
- ◀ pw /V1/MEDIA/USB/H1/D1.Power5VMode=Auto

### 8.11.6. Setting the USB Autoselect Policy

#### Command and Response

- ▶ SET·/V1/MEDIA/USB/AUTOSELECT/H1.Policy=<op\_mode>
- ◀ pw·/V1/MEDIA/USB/AUTOSELECT/H1.Policy=<op\_mode>

#### Parameters

Parameter	Parameter description	Values	Value description
<op_mode>	Operation mode	<b>Off</b>	The autoselect function is disabled.
		<b>Last Detect</b>	It is always the last attached input that is switched to the output automatically.
		<b>First Detect</b>	The first active USB input is selected.
		<b>Follow video</b>	Follows the video crosspoint state automatically.

#### Example

- ▶ SET /V1/MEDIA/USB/AUTOSELECT/H1.Policy=Follow video
- ◀ pw /V1/MEDIA/USB/AUTOSELECT/H1.Policy=Follow video

### 8.11.7. Setting the Followed Video Port to Autoselect

#### Command and Response

- ▶ SET·/V1/MEDIA/USB/AUTOSELECT/H1.VideoFollowPort=<out>
- ◀ pw·/V1/MEDIA/USB/AUTOSELECT/H1.VideoFollowPort=<out>

#### Example

- ▶ SET /V1/MEDIA/USB/AUTOSELECT/H1.VideoFollowPort=01
- ◀ pw /V1/MEDIA/USB/AUTOSELECT/H1.VideoFollowPort=01

### 8.11.8. Changing the Autoselect Included USB Ports

#### Command and Response

- ▶ SET·/V1/MEDIA/USB/AUTOSELECT/H1/<host>.Included=<state>
- ◀ pw·/V1/MEDIA/USB/AUTOSELECT/H1/<host>.Included=<state>

#### Parameters

Parameter	Parameter description	Values	Value description
<host>	USB Host	U1-U4	USB-C and USB-B port number
<state>	The chosen input is ignored in the autoselect process or not.	true	The port is included in autoselect.
		false	The autoselect function ignores that port.

#### Example

- ▶ SET /V1/MEDIA/USB/AUTOSELECT/H1/U1.Included=true
- ◀ pw /V1/MEDIA/USB/AUTOSELECT/H1/U1.Included=true

### 8.11.9. Changing the USB Port Priority

#### Command and Response

- ▶ SET·/V1/MEDIA/USB/AUTOSELECT/H1/<host>.Priority=<prio\_num>
- ◀ pw·/V1/MEDIA/USB/AUTOSELECT/H1/<host>.Priority=<prio\_num>

#### Parameters

Parameter	Parameter description	Values	Value description
<host>	USB Host	U1-U4	USB-C and USB-B port number
<prio_num>	Priority number from 1 to 100, equal numbers are allowed.	1-100	1: the highest priority 100: the lowest priority

#### Example

- ▶ SET /V1/MEDIA/USB/AUTOSELECT/H1/U1.Priority=51
- ◀ pw /V1/MEDIA/USB/AUTOSELECT/H1/U1.Priority=51

### 8.12. USB Port Settings - USB-C Related Commands

INFO: USB-C port numbers may differ depending on the model. For more information, see the [Port Numbering](#) section.

**DIFFERENCE:** UCX-3x3-TPX-RX20 and HDMI-UCX-TPX-RX107 models do not have USB-C ports.

#### 8.12.1. Setting the USB-C Power

##### Command and Response #power

- ▶ SET·/V1/MEDIA/USB/<port\_number>/POWER.Reserved=<power>
- ◀ pw·/V1/MEDIA/USB/<port\_number>/POWER.PowerLimit=<power>

##### Parameters

Parameter	Parameter description	Values	Value description
<power>	Power output for the USB-C ports	15 W	15W power minimum*
		30 W	30W power minimum*
		60 W	60W power minimum*
		100 W	100W power minimum*
<port_number>	USB-C Port number	U1-U2	USB-C port number

\* In case of **Static** Allocation Mode, this is the maximum amount of output power, if the Allocation mode is **Auto**, it is the minimum amount of output power.

##### Example

- ▶ SET /V1/MEDIA/USB/U1/POWER.Reserved=30 W
- ◀ pw /V1/MEDIA/USB/U1/POWER.Reserved=30 W

#### 8.12.2. Setting the Power Allocation Mode

##### Command and Response

- ▶ GET·/V1/MEDIA/USB/<port\_number>/POWER.AllocationMode=<allocation\_mode>
- ◀ pr·/V1/MEDIA/USB/<port\_number>/POWER.AllocationMode=<allocation\_mode>

##### Parameters

Parameter	Parameter description	Value	Value description
<allocation_mode>	Power Allocation Mode	Static	The power set on the port is being output.
		Auto	The power set on the port is the minimum output, which can increase automatically depending on the amount of unallocated power.
<port_number>	USB-C Port number	U1-U2	USB-C port number

##### Example

- ▶ GET /V1/MEDIA/USB/U1/POWER.AllocationMode=Static
- ◀ pr /V1/MEDIA/USB/U1/POWER.AllocationMode=Static

### 8.12.3. Setting the Displayport Alternate Mode Policy

**DIFFERENCE:** From firmware version v1.8.0 and LDC version v2.8.0, UCX-4x3-TPX-TX20 and UCX-2x1-TPX-TX20 models have **2 Lane Video** setting alongside **4 Lane Video** setting in case the latter is not supported.

#### Command and Response

- ▶ SET /V1/MEDIA/USB/<usb\_port>.DpAltModePolicy=<dp\_policy>
- ◀ pr /V1/MEDIA/USB/<usb\_port>.DpAltModePolicy=<dp\_policy>

#### Parameters

Parameter	Parameter description	Values	Value description
<usb-c_port>	USB-C port number	U1-U2	USB-C port number
<dp_policy>	The preferred video or USB data transmission	Auto	Auto: Taurus offers both operation modes described below. A BYOD device can choose between the two. 4 lane DP Alt mode operation (4K@60) is not guaranteed.
		Force C	It means 4 Lane Video setting.
		Force D	It means 2 Lane Video setting. It is used when 4 Lane mode is not supported.

#### Example

- ▶ SET /V1/MEDIA/USB/U2.DpAltModePolicy=Auto
- ◀ pr /V1/MEDIA/USB/U2.DpAltModePolicy=Auto

**ATTENTION!** Changing DpAltModePolicy is recommended before connecting a computer to the input.

### 8.12.4. Querying the Host Alternate Mode Support

#### Command and Response

- ▶ GET /V1/MEDIA/USB/<usb-c\_port>.HostSupportsDpAltMode
- ◀ pr /V1/MEDIA/USB/<usb-c\_port>.HostSupportsDpAltMode=<altmode\_support>

#### Parameters

Parameter	Parameter description	Value	Value description
<usb-c_port>	USB-C port number	U1-U2	USB-C port number
<altmode_support>		False	The host does not support the alternate mode.
		True	The host supports the alternate mode.

#### Example

- ▶ GET /V1/MEDIA/USB/U1.HostSupportsDpAltMode
- ◀ pr /V1/MEDIA/USB/U1.HostSupportsDpAltMode=true

### 8.12.5. Querying the Status of the Alternate Mode

#### Command and Response #dpaltmode #alternatemode #displayportalternatemode

- ▶ GET /V1/MEDIA/USB/<usb-c\_port>.ActiveAltMode
- ◀ pr /V1/MEDIA/USB/<usb-c\_port>.ActiveAltMode=<altmode\_state>

#### Parameters

Parameter	Parameter description	Value	Value description
<usb-c_port>	USB-C port number	U1-U2	USB-C port number
<altmode_state>		N/A	The host is not connected
		None	DP Alt mode is not active
		DP	DP Alt mode is active.

#### Example

- ▶ GET /V1/MEDIA/USB/U2.ActiveAltMode
- ◀ pr /V1/MEDIA/USB/U2.ActiveAltMode=DP

### 8.12.6. Querying the Port Data Role

#### Command and Response

- ▶ GET /V1/MEDIA/USB/<usb\_port>.ActivePortDataRole
- ◀ pr /V1/MEDIA/USB/<usb\_port>.ActivePortDataRole=<data\_role>

#### Parameters

Parameter	Parameter description	Values	Value description
<usb-c_port>	USB-C port number	U1-U2	USB-C port number
<data_role>		N/A	No information about the data role.
		DFP	Downstream Facing Port (usually a Host / HUB ports) The port data role is configured as USB Host. This is for building up the connection (USB data transmission operates after the data role swap)
		UFP	Upstream Facing Port (usually a device)

- ▶ GET /V1/MEDIA/USB/U2.ActivePortDataRole
- ◀ pr /V1/MEDIA/USB/U2.ActivePortDataRole=UFP



### 8.12.7. Querying the Port Power Role

#### Command and Response *#power*

- ▶ GET·/V1/MEDIA/USB/<usb\_port>.ActivePortPowerRole
- ◀ pr·/V1/MEDIA/USB/<usb\_port>.ActivePortPowerRole=<power\_role>

#### Parameters

Parameter	Parameter description	Values	Value description
<usb-c_port>	USB-C port number	U1-U2	USB-C port number
<power_role>		N/A	No information about the power role.
		Sink	The port is configured as a sink.
		Source	The port is configured as a source.

#### Example

- ▶ GET /V1/MEDIA/USB/U2.ActivePortPowerRole
- ◀ pr /V1/MEDIA/USB/U2.ActivePortPowerRole=Source

### 8.12.8. Setting the Port Power Role

#### Command and Response

- ▶ SET·/V1/MEDIA/USB/<usb-c\_port>.PortPowerRoleSetting=<power\_role>
- ◀ pw·/V1/MEDIA/USB/<usb\_port>.PortPowerRoleSetting=<power\_role>

#### Parameters

Parameter	Parameter description	Values	Value description
<usb-c_port>	USB-C port number	U1-U2	USB-C port number
<power_role>		Sink	The port is configured as a sink.
		Source	The port is configured as a source.
		Dual Role	The port is configured to be in Dual Power Role mode.

#### Example

- ▶ SET /V1/MEDIA/USB/U1.PortPowerRoleSetting=Dual Role
- ◀ pw /V1/MEDIA/USB/U1.PortPowerRoleSetting=Dual Role

### 8.13. EDID Management

**DIFFERENCE:** These commands are not available for HDMI-UCX-TPX-RX107.

#### 8.13.1. Querying the Emulated EDIDs

##### Command and Response *#edid*

- ▶ GET·/V1/EDID.EdidStatus
- ◀ pr·/V1/EDID.EdidStatus=<source>:E1;<source>:E2; <source>:E3;<source>:E4

##### Parameters

Parameter	Parameter description	Values	Value description
<source>	Source EDID memory place	F1-F120	Factory EDIDs
		U1-U14	User EDIDs
		D1-D2	Dynamic EDIDs

#### Example

- ▶ GET /V1/EDID.EdidStatus
- ◀ pr /V1/EDID.EdidStatus=F89:E1;D1:E2;D1:E3;D1:E4

Emulated EDID memory for input port is listed with the EDID number that is currently emulated on the input.

#### 8.13.2. Querying the Validity of a Dynamic EDID

##### Command and Response

- ▶ GET·/V1/EDID/D/D1.Validity
- ◀ pr·/V1/EDID/D/D1.Validity=<validity>

##### Parameters

If the <validity> parameter is **true**, the EDID is valid. If the parameter is **false**, the EDID is invalid.

#### Example

- ▶ GET /V1/EDID/D/D1.Validity
- ◀ pr /V1/EDID/D/D1.Validity=true

The 'Validity' property is true, valid EDID is stored in D1 memory place.

### 8.13.3. Querying the Preferred Resolution of a User EDID

#### Command and Response

- ▶ GET /V1/EDID/U/<user\_edid>.PreferredResolution
- ◀ pr /V1/EDID/U/<user\_edid>.PreferredResolution=<preferred\_resolution>

#### Example

- ▶ GET /V1/EDID/U/U2.PreferredResolution
- ◀ pr /V1/EDID/U/U2.PreferredResolution=1920x1080p60.00Hz

INFO: Use the **Manufacturer** and **MonitorName** properties to query further information.

### 8.13.4. Emulating an EDID to an Input Port

#### Command and Response

- ▶ CALL /V1/EDID:switch(<source>:<destination>)
- ◀ m0 /V1/EDID:switch

#### Parameters

Parameter	Parameter description	Values	Value description
<source>	Source EDID memory place	F1-F120	Factory EDIDs
		U1-U14	User EDIDs
		D1-D2	Dynamic EDIDs
<destination>	The emulated EDID memory of the desired input port	U1-U14	User EDIDs

#### Example

- ▶ CALL /V1/EDID:switch(F49:E2)
- ◀ m0 /V1/EDID:switch

### 8.13.5. Emulating an EDID to All Input Ports

#### Command and Response

- ▶ CALL /V1/EDID:switchAll(<source>)
- ◀ m0 /V1/EDID:switchAll

#### Parameters

Parameter	Parameter description	Values	Value description
<source>	Source EDID memory place	F1-F148	Factory EDIDs
		U1-U100	User EDIDs
		D1-D2	Dynamic EDIDs

#### Example

- ▶ CALL /V1/EDID:switchAll(F47)
- ◀ m0 /V1/EDID:switchAll

### 8.13.6. Copying an EDID to User Memory

#### Command and Response

- ▶ CALL /V1/EDID:copy(<source>:<destination>)
- ◀ m0 /V1/EDID:copy

#### Parameters

Parameter	Parameter description	Values	Value description
<source>	Source EDID memory place	F1-F148	Factory EDIDs
		U1-U100	User EDIDs
		D1-D2	Dynamic EDIDs
<destination>	The emulated EDID memory of the desired input port	U1-U100	User EDIDs

#### Example

- ▶ CALL /V1/EDID:copy(F1:U2)
- ◀ m0 /V1/EDID:copy

### 8.13.7. Deleting an EDID from User Memory

#### Command and Response

- ▶ CALL /V1/EDID:delete(<user\_edid>)
- ◀ m0 /V1/EDID:delete

#### Parameters

Parameter	Parameter description	Values	Value description
<user_edid>	The emulated EDID memory of the desired input port.	U1-U14	User EDIDs

#### Example

- ▶ CALL /V1/EDID:delete(U2)
- ◀ m0 /V1/EDID:delete

### 8.13.8. Resetting the Emulated EDIDs

#### Command and Response

- ▶ CALL /V1/EDID:reset()
- ◀ m0 /V1/EDID:reset

#### Parameters

Parameter	Parameter description	Values	Value description
<user_edid>	The emulated EDID memory of the desired input port.	U1-U14	User EDIDs

#### Example

- ▶ CALL /V1/EDID:reset()
- ◀ m0 /V1/EDID:reset

Calling this method switches all emulated EDIDs to a factory default one. See the table in the [Factory EDID List](#) section.

## 8.14. Ethernet Port Configuration

### 8.14.1. Setting the DHCP State

**ATTENTION!** When you change a network property, the new value is stored, but the **applySettings** method must always be called to apply the new settings. When two or more network parameters are changed, the **applySettings** method is enough to be called once as a final step; it will reboot the device.

#### Command and Response #dhcp #network #ipaddress

- ▶ SET /V1/MANAGEMENT/NETWORK.DhcpEnabled=<dhcp\_status>
- ◀ pw /V1/MANAGEMENT/NETWORK.DhcpEnabled=<dhcp\_status>

#### Parameters

If the <dhcp\_status> parameter is **true**, the current IP address setting is DHCP, if the parameter is **false**, the current IP address is static.

#### Example

- ▶ SET /V1/MANAGEMENT/NETWORK.DhcpEnabled=true
- ◀ pw /V1/MANAGEMENT/NETWORK.DhcpEnabled=true
- ▶ CALL /V1/MANAGEMENT/NETWORK:applySettings()
- ◀ m0 /V1/MANAGEMENT/NETWORK:applySettings

INFO: The **applySettings** method will save and apply the new value, and it will reboot the device.

INFO: The current setting can be queried by using the [GET Command](#).

### 8.14.2. Changing the IP Address (Static)

#### Command and Response

- ▶ SET /V1/MANAGEMENT/NETWORK.StaticIpAddress=<IP\_address>
- ◀ pw /V1/MANAGEMENT/NETWORK.StaticIpAddress=<IP\_address>

#### Example

- ▶ SET /V1/MANAGEMENT/NETWORK.StaticIpAddress=192.168.0.85
- ◀ pw /V1/MANAGEMENT/NETWORK.StaticIpAddress=192.168.0.85
- ▶ CALL /V1/MANAGEMENT/NETWORK:applySettings()
- ◀ m0 /V1/MANAGEMENT/NETWORK:applySettings

INFO: The **applySettings** method will save and apply the new value and it will reboot the device.

INFO: The current setting can be queried by using the [GET Command](#).

### 8.14.3. Changing the Subnet Mask (Static)

#### Command and Response #ipaddress

- ▶ SET /V1/MANAGEMENT/NETWORK.StaticNetworkMask=<netmask>
- ◀ pw /V1/MANAGEMENT/NETWORK.StaticNetworkMask=<netmask>

#### Example

- ▶ SET /V1/MANAGEMENT/NETWORK.StaticNetworkMask=255.255.255.0
- ◀ pw /V1/MANAGEMENT/NETWORK.StaticNetworkMask=255.255.255.0
- ▶ CALL /V1/MANAGEMENT/NETWORK:applySettings()
- ◀ m0 /V1/MANAGEMENT/NETWORK:applySettings

INFO: The `applySettings` method will save and apply the new value and it will reboot the device.

INFO: The current setting can be queried by using the [GET Command](#).

### 8.14.4. Changing the Gateway Address (Static)

#### Command and Response

- ▶ SET /V1/MANAGEMENT/NETWORK.StaticGatewayAddress=<gw\_address>
- ◀ pw /V1/MANAGEMENT/NETWORK.StaticGatewayAddress=<gw\_address>

#### Example

- ▶ SET /V1/MANAGEMENT/NETWORK.StaticGatewayAddress=192.168.0.5
- ◀ pw /V1/MANAGEMENT/NETWORK.StaticGatewayAddress=192.168.0.5
- ▶ CALL /V1/MANAGEMENT/NETWORK:applySettings()
- ◀ m0 /V1/MANAGEMENT/NETWORK:applySettings

INFO: The `applySettings` method will save and apply the new value, and it will reboot the device.

INFO: The current setting can be queried by using the [GET Command](#).

### 8.14.5. Applying the Network Settings

#### Command and Response

- ▶ CALL /V1/MANAGEMENT/NETWORK:applySettings()
- ◀ m0 /V1/MANAGEMENT/NETWORK:applySettings

#### Example

- ▶ CALL /V1/MANAGEMENT/NETWORK:applySettings()
- ◀ m0 /V1/MANAGEMENT/NETWORK:applySettings

All network settings that were changed are applied and network interface restarts.

### 8.14.6. Setting the Host name

The host name is a property that can be used instead of the IP address when connecting to the device. It is also suitable for finding the device in the Device Discovery window of the LDC, see more details in the [Add New Favorite Device](#) section. If the IP address of the device is changing, the host name can be used as a fixed property.

Restarting HTTP(S) Services is required after the host name changed. A new certificate is generated after modifying the host name.

#### Command and Response

- ▶ SET /V1/MANAGEMENT/NETWORK.HostName=<unique\_name>
- ◀ pw /V1/MANAGEMENT/NETWORK.HostName=<unique\_name>

#### Parameters

The <unique\_name> can be 1-64 character(s) long, and the following are allowed for naming: the elements of the English alphabet and numbers. Hyphen (-) is also accepted, except as last character.

#### Example

- ▶ SET /V1/MANAGEMENT/NETWORK.HostName=room-switcher
- ◀ pw /V1/MANAGEMENT/NETWORK.HostName=room-switcher

## 8.15. Remote Power

### 8.15.1. Enabling/Disabling Remote Power

**DIFFERENCE:** This setting is only available for UCX-4x3-TPX-TX20 and UCX-2x1-TPX-TX20, and only in case the receiver is HDMI-UCX-TPX-RX107.

Allows the user to toggle PoE on the TPX output port.

#### Command and Response

- ▶ SET /V1/LINK/TX/POE/POWER.Reserved=<output\_power>
- ◀ pw /V1/LINK/TX/POE/POWER.Reserved=<output\_power>

#### Parameters

Parameter	Parameter description	Values	Value description
<output_power>	Reserved power for the TPX port	30 W	Remote power is enabled
		0 W	Remote power is disabled

#### Example

- ▶ SET /V1/LINK/TX/POE/POWER.Reserved=30 W
- ◀ pw /V1/LINK/TX/POE/POWER.Reserved=30 W

## 8.16. Network Security

### 8.16.1. Enabling/Disabling the Ethernet Port

#### Command and Response

- ▶ SET /V1/MEDIA/ETHERNET/<ethernet\_port>.Enabled=<status>
- ◀ pw /V1/MEDIA/ETHERNET/<ethernet\_port>.Enabled=<status>

#### Parameters

Parameter	Parameter description	Values	Value description
<ethernet_port>	Ethernet port number	P1-P7*	
		true	The port is enabled.
		false	The port is disabled.

\* UCX-2x1-TPX-TX20 model only has four Ethernet ports, plus it can control the two Ethernet ports of the HDMI-UCX-TPX-RX107 (P1-P6).

#### Example

- ▶ SET /V1/MEDIA/ETHERNET/P4.Enabled=true
- ◀ pw /V1/MEDIA/ETHERNET/P4.Enabled=true

### 8.16.2. Querying the Service Port Number

#### Command and Response

- ▶ GET /V1/MANAGEMENT/NETWORK/SERVICES/<port>.Port
- ◀ pr /V1/MANAGEMENT/NETWORK/SERVICES/<port>.Port=<port\_num>

#### Parameters

Parameter	Parameter description	Parameter values
<port>	Port type	HTTP HTTPS LW3 UART1 UART2
<port_num>	Port number	80 443 6107 8001 8002

#### Example

- ▶ GET /V1/MANAGEMENT/NETWORK/SERVICES/HTTP.Port
- ◀ pr /V1/MANAGEMENT/NETWORK/SERVICES/HTTP.Port=80

### 8.16.3. Enabling/Disabling the Service Port

#### Command and Response #http #https

- ▶ SET /V1/MANAGEMENT/NETWORK/SERVICES/<port>.Enabled=<status>
- ◀ pw /V1/MANAGEMENT/NETWORK/SERVICES/<port>.Enabled=<status>

#### Parameters

Parameter	Parameter description	Values	Value description
<port>	Port type	HTTP HTTPS	
<status>		true	The port is enabled.
		false	The port is disabled.

#### Example

- ▶ SET /V1/MANAGEMENT/NETWORK/SERVICES/HTTP.Enabled=true
- ◀ pw /V1/MANAGEMENT/NETWORK/SERVICES/HTTP.Enabled=true

### 8.16.4. Querying the Username for Authentication

INFO: UCX-TPX series devices deal with one user for authentication and the username (admin) can not be changed.

#### Command and Response

- ▶ GET /V1/MANAGEMENT/NETWORK/AUTH/USER1.Name
- ◀ pr /V1/MANAGEMENT/NETWORK/AUTH/USER1.Name=admin

#### Example

- ▶ GET /V1/MANAGEMENT/NETWORK/AUTH/USER1.Name
- ◀ pr /V1/MANAGEMENT/NETWORK/AUTH/USER1.Name=admin

### 8.16.5. Enabling the Authentication

INFO: Set the password before enabling the authentication, because no password is set by default.

#### Command and Response

- ▶ SET /V1/MANAGEMENT/NETWORK/SERVICES/<port>.AuthenticationEnabled=<status>
- ◀ pw /V1/MANAGEMENT/NETWORK/SERVICES/<port>.AuthenticationEnabled=<status>
- ▶ CALL /V1/MANAGEMENT/NETWORK/SERVICES/HTTP:restart()
- ◀ mO /V1/MANAGEMENT/NETWORK/SERVICES/HTTP:restart=

#### Parameters

Parameter	Parameter description	Values	Value description
<port>	Port type	HTTP HTTPS	
<status>		true false	The authentication is enabled. The authentication is disabled.

#### Example

- ▶ SET /V1/MANAGEMENT/NETWORK/SERVICES/HTTP.AuthenticationEnabled=true
- ◀ pw /V1/MANAGEMENT/NETWORK/SERVICES/HTTP.AuthenticationEnabled=true
- ▶ CALL /V1/MANAGEMENT/NETWORK/SERVICES/HTTP:restart()
- ◀ mO /V1/MANAGEMENT/NETWORK/SERVICES/HTTP:restart=

INFO: Restart HTTP(S) Services is required after the authentication settings changed.

### 8.16.6. Restatring the Network Services

#### Command and Response #http #https

- ▶ CALL /V1/MANAGEMENT/NETWORK/SERVICES/<port>:restart()
- ◀ mO /V1/MANAGEMENT/NETWORK/SERVICES/<port>:restart=

#### Parameters

Parameter	Parameter description	Parameter values
<port>	Port type	HTTP HTTPS

#### Example

- ▶ CALL /V1/MANAGEMENT/NETWORK/SERVICES/HTTP:restart()
- ◀ mO /V1/MANAGEMENT/NETWORK/SERVICES/HTTP:restart=

### 8.16.7. Setting the VLAN ID

You can create separate networks by setting different VLAN IDs for the Ethernet ports. You can create any number of setups for limiting access to the corporate or management network or providing separate networks for each user. Default VLAN ID is 1 for all of the ports.

**DIFFERENCE:** From FW version v1.13.0b3, VLAN ID 1000 is reserved for the Management network.

#### Command and Response

- ▶ SET /V1/MEDIA/ETHERNET/<port>.VlanMembership=<vlan\_id>
- ◀ pw /V1/MEDIA/ETHERNET/<port>.VlanMembership=<vlan\_id>

#### Example

- ▶ SET /V1/MEDIA/ETHERNET/P1.VlanMembership=2
- ◀ pw /V1/MEDIA/ETHERNET/P1.VlanMembership=2

## 8.17. Serial Port Configuration

### 8.17.1. BAUD Rate Setting

**Command and Response** *#rs-232 #rs232*

- ▶ SET /V1/MEDIA/SERIAL/<serial\_port>.Baudrate=<baudrate>
- ◀ pw /V1/MEDIA/SERIAL/<serial\_port>.Baudrate=<baudrate>

**Parameters**

Identifier	Parameter description	Parameter values
<serial_port>	Serial port number	P1-P2
<baudrate>	Baud rate value	9600 19200 38400 57600 115200

**Example**

- ▶ SET /V1/MEDIA/SERIAL/P1.Baudrate=19200
- ◀ pw /V1/MEDIA/SERIAL/P1.Baudrate=19200

### 8.17.2. Stop Bits Setting

**Command and Response** *#rs-232 #rs232*

- ▶ SET /V1/MEDIA/SERIAL/<serial\_port>.StopBits=<stopbits>
- ◀ pw /V1/MEDIA/SERIAL/<serial\_port>.StopBits=<stopbits>

**Parameters**

Identifier	Parameter description	Parameter values
<serial_port>	Serial port number	P1-P2
<stopbits>	Stop bit value	1 2

**Example**

- ▶ SET /V1/MEDIA/SERIAL/P1.StopBits=1
- ◀ pw /V1/MEDIA/SERIAL/P1.StopBits=1

### 8.17.3. Querying the Data Bits

**Command and Response** *#rs-232 #rs232*

- ▶ GET /V1/MEDIA/SERIAL/<serial\_port>.DataBits
- ◀ pr /V1/MEDIA/SERIAL/<serial\_port>.DataBits=<databits>

**Parameters**

Identifier	Parameter description	Parameter values
<serial_port>	Serial port number	P1-P2
<databits>	DataBits value	8 9

**Example**

- ▶ GET /V1/MEDIA/SERIAL/P1.DataBits
- ◀ pr /V1/MEDIA/SERIAL/P1.DataBits=8

### 8.17.4. Parity Setting

**Command and Response** *#rs-232 #rs232*

- ▶ SET /V1/MEDIA/SERIAL/<serial\_port>.Parity=<parity>
- ◀ pw /V1/MEDIA/SERIAL/<serial\_port>.Parity=<parity>

**Parameters**

Identifier	Parameter description	Parameter values
<serial_port>	Serial port number	P1-P2
<parity>	Parity value	None Odd Even

**Example**

- ▶ SET /V1/MEDIA/SERIAL/P1.Parity=None
- ◀ pw /V1/MEDIA/SERIAL/P1.Parity=None

## 8.18. Sending a Message via RS-232

**ATTENTION!** Serial message sending is implemented only via Lightware REST API. This function is not available with LW3 protocol command. For more details, see [Serial Port Messaging](#).

## 8.19. GPIO Port Configuration

**DIFFERENCE:** The HDMI-UCX-TPX-RX107 receiver does not have a GPIO port.

### 8.19.1. Querying the Direction of a GPIO Pin

**Command and Response** *#gpio*

- ▶ GET·/V1/MEDIA/GPIO/<port>.Direction
- ◀ pw·/V1/MEDIA/GPIO/<port>.Direction(<dir>)

**Parameters**

Parameter	Parameter description	Value	Value description
<dir>	The direction of the GPIO pin.	Input	input
		Output	output

**Example**

- ▶ GET /V1/MEDIA/GPIO/P1.Direction
- ◀ pw /V1/MEDIA/GPIO/P1.Direction=Input

### 8.19.2. Setting the Direction of a GPIO Pin

**Command and Response**

- ▶ SET·/V1/MEDIA/GPIO/<port>.Direction(<dir>)
- ◀ pw·/V1/MEDIA/GPIO/<port>.Direction(<dir>)

**Parameters**

See the previous section.

**Example**

- ▶ SET /V1/MEDIA/GPIO/P1.Direction=Input
- ◀ pw /V1/MEDIA/GPIO/P1.Direction=Input

### 8.19.3. Querying the Output Level of a GPIO Pin

**Command and Response**

- ▶ GET·/V1/MEDIA/GPIO/<port>.Output
- ◀ pw·/V1/MEDIA/GPIO/<port>.Output(<value>)

**Parameters**

Parameter	Parameter description	Value	Value description
<value>	The output value of the GPIO pin.	High	high level
		Low	low level

**Example**

- ▶ GET /V1/MEDIA/GPIO/P1.Output
- ◀ pw /V1/MEDIA/GPIO/P1.Output=Low

### 8.19.4. Setting the Output Level of a GPIO Pin

**Command and Response**

- ▶ SET·/V1/MEDIA/GPIO/<port>.Output(<value>)
- ◀ pw·/V1/MEDIA/GPIO/<port>.Output(<value>)

**Parameters**

See the previous section.

**Example**

- ▶ SET /V1/MEDIA/GPIO/P1.Output=High
- ◀ pw /V1/MEDIA/GPIO/P1.Output=High

### 8.19.5. Setting the Output Level for a Specified Time

**Command and Response**

- ▶ CALL·/V1/MEDIA/GPIO/<port>.interval(<value>;<time>)
- ◀ m0·/V1/MEDIA/GPIO/<port>.interval=

**Parameters**

Parameter	Parameter description	Value	Value description
<value>	The output value of the GPIO pin.	High	high level
		Low	low level
<time>	Duration of the desired value in seconds.	1-120	second(s)

**Example**

- ▶ CALL /V1/MEDIA/GPIO/P1.interval(Low;1)
- ◀ m0 /V1/MEDIA/GPIO/P1.interval=

### 8.19.6. Toggling the Level of a GPIO Pin

The output level can be changed from high to low and from low to high by the command below.

**Command and Response**

- ▶ CALL·/V1/MEDIA/GPIO/<port>.toggle()
- ◀ m0·/V1/MEDIA/GPIO/<port>.toggle

**Example**

- ▶ CALL /V1/MEDIA/GPIO/P1.toggle()
- ◀ m0 /V1/MEDIA/GPIO/P1.toggle



## 8.20. OCS Port Configuration

**DIFFERENCE:** Occupancy sensor-related commands are available only from FW package 1.2.0b3.

**DIFFERENCE:** The UCX-4x3-TPX-TX20 and UCX-2x1-TPX-TX20 transmitters do not have an OCS port, however they can control the OCS port of the HDMI-UCX-TPX-RX107 receiver.

### 8.20.1. Querying the Input Level of an OCS Pin

#### Command and Response #ocs

- ▶ GET·/V1/MEDIA/OCS/P1.InputLevel
- ◀ pr·/V1/MEDIA/OCS/P1.InputLevel=<value>

#### Parameters

Parameter	Parameter description	Value	Value description
<value>	The input value of the OCS pin.	High	high level
		Low	low level

#### Example

- ▶ GET /V1/MEDIA/OCS/P1.InputLevel
- ◀ pr /V1/MEDIA/OCS/P1.InputLevel=Low

### 8.20.2. Setting the Sensor Type

#### Command and Response

- ▶ SET·/V1/MEDIA/OCS/P1.SensorType=<sensor\_type>
- ◀ pw·/V1/MEDIA/OCS/P1.SensorType=<sensor\_type>

#### Parameters

Parameter	Parameter description	Value	Value description
<sensor_type>	It defines whether the low or high input level means the occupancy.	Active low	Occupancy status is 'Occupied' when the input level is low.
		Active high	Occupancy status is 'Occupied' when the input level is high (default value).

#### Example

- ▶ SET /V1/MEDIA/OCS/P1.SensorType=Active low
- ◀ pw /V1/MEDIA/OCS/P1.SensorType=Active low

### 8.20.3. Querying the Reported OCS State

#### Command and Response

- ▶ GET·/V1/MEDIA/OCS/P1.State
- ◀ pr·/V1/MEDIA/OCS/P1.State=<status>

#### Parameters

Parameter	Parameter description	Value	Value description
<status>	It reports the occupancy state of the room depending on the sensor type.	Free	When the SensorType=Active high and the Inputlevel=Low or when SensorType=Active low and Inputlevel=High
		Occupied	When the SensorType=Active high and the Inputlevel=High or when SensorType=Active low and Inputlevel=Low

#### Example

- ▶ GET /V1/MEDIA/OCS/P1.State
- ◀ pr /V1/MEDIA/OCS/P1.State=Free

## 8.21. LW3 Commands - Quick Summary

### System Commands

#### Setting the Device Label

- ▶ SET·/V1/MANAGEMENT/LABEL.DeviceLabel=<custom\_name>

#### Resetting the Device

- ▶ CALL·/V1/SYS/DEVICES/<TX/RX>:restart()

#### Restoring the Factory Default Settings

- ▶ CALL·/V1/SYS/DEVICES/<TX/RX>:factoryDefaults()

#### Querying the Firmware Package Version

- ▶ GET·/V1/MANAGEMENT/UID/PACKAGE.Version

#### Control Lock

- ▶ SET·/V1/MANAGEMENT/UI.ControlLock=<lock\_status>

#### Setting the Current Time

- ▶ CALL·/V1/MANAGEMENT/DATETIME:setTime(<current\_time>)

#### Identifying the Device

- ▶ CALL /V1/MANAGEMENT/UI:identifyMe()

#### Toggling the Dark Mode Setting

- ▶ SET·/V1/MANAGEMENT/UI/DARKMODE.Enable=<mode\_state>

#### Setting the Delay of the Dark Mode Setting

- ▶ SET·/V1/MANAGEMENT/UI/DARKMODE.Delay=<delay\_time>

### Video Port Settings - General

#### Switching Video Input

- ▶ CALL·/V1/MEDIA/VIDEO/XP:switch(<in>:<out>)

#### Switching an Input to All Outputs

- ▶ CALL·/V1/MEDIA/VIDEO/XP:switchAll(<input>)

#### Locking the Video Port

- ▶ SET·/V1/MEDIA/VIDEO/XP/<port>.Lock=<locked\_state>

#### Muting the Video Port

- ▶ SET·/V1/MEDIA/VIDEO/XP/<port>.Mute=<muted\_state>

#### Setting the Autoselect Policy

- ▶ SET·/V1/MEDIA/VIDEO/AUTOSELECT/<out>.Policy=<autoselect\_mode>

#### Changing the Autoselect Included Input Ports

- ▶ SET·/V1/MEDIA/VIDEO/AUTOSELECT/<out>/<in>.Included=<state>

#### Changing the Input Port Priority

- ▶ SET·/V1/MEDIA/VIDEO/AUTOSELECT/<out>/<in>.Priority=<prio\_num>

#### Querying the Connected Source

- ▶ GET·/V1/MEDIA/VIDEO/XP/<out>.ConnectedSource

#### Querying the Input Switching Capability

- ▶ GET·/V1/MEDIA/VIDEO/XP/<out>/SWITCHABLE.<in>

#### Querying the Connected Destinations

- ▶ GET·/V1/MEDIA/VIDEO/XP/<n>.ConnectedDestinations

#### Querying the Video Signal Presence

- ▶ GET·/V1/MEDIA/VIDEO/<port>.SignalPresent

#### HDCP Setting (Input Port)

- ▶ SET·/V1/MEDIA/VIDEO/<in>/HDCP.AllowedHdcpVersion=<allowed\_hdcp>

#### HdcpMode

- ▶ SET·/V1/MEDIA/VIDEO/<out>.HdcpMode=<hdcp\_mode>

#### OutputSignalType

- ▶ SET·/V1/MEDIA/VIDEO/<out>.OutputSignalType=<signal\_type>

#### EmbeddedAudioPresent

- ▶ GET·/V1/MEDIA/VIDEO/<port>.EmbeddedAudioPresent

#### EmbeddedAudioMute

- ▶ SET·/V1/MEDIA/VIDEO/<port>.EmbeddedAudioMute=<mute\_state>

#### Output5VMode

- ▶ SET·/V1/MEDIA/VIDEO/<out>.Output5VMode=<5V\_pwr>

#### HDCP Capability (Output Port)

- ▶ GET·/V1/MEDIA/VIDEO/<out>/HDCP/SinkMaxHdcpVersion=<hdcp\_ver>

#### HDCP Setting (Output Port)

- ▶ GET·/V1/MEDIA/VIDEO/<out>/HDCP.AllowedHdcpVersion=<allowed\_hdcp>

### Welcome Screen Settings

#### Displaying the Welcome Screen Image

- ▶ SET·/V1/MEDIA/VIDEO/I5/WELCOMESCREEN.ImageEnabled=<image\_state>

**Displaying the Welcome Screen Text**

- ▶ SET·/V1/MEDIA/VIDEO/I5/WELCOMESCREEN.MessageEnabled=<text\_state>

**Setting the Welcome Screen Text**

- ▶ SET·/V1/MEDIA/VIDEO/I5/WELCOMESCREEN.MessageText=<text>

**Resetting the Welcome Screen Image**

- ▶ CALL·/V1/MEDIA/VIDEO/I5/WELCOMESCREEN.resetImage()

**Video Port Settings - USB-C Related Commands****Restarting the Link Training**

- ▶ CALL·/V1/MEDIA/VIDEO/<in>/DP.restartLinkTraining()

**CEC Command Sending****Simple CEC Code Sending**

- ▶ CALL /V1/MEDIA/VIDEO/<out>/CEC:send(<command>)

**Remote Control Code Sending**

- ▶ CALL·/V1/MEDIA/VIDEO/<port>/CEC:sendUserControlClick(<command>)

**Audio Port Settings****Switching the Audio Input**

- ▶ CALL·/V1/MEDIA/AUDIO/XP:switch(<audio\_in>:O3)

**Querying the Connected Source**

- ▶ GET·/V1/MEDIA/AUDIO/XP/O3.ConnectedSource

**Querying the Connected Destinations**

- ▶ GET·/V1/MEDIA/AUDIO/XP/<audio\_in>.ConnectedDestinations

**Setting the Autoselect Operation Mode**

- ▶ SET·/V1/MEDIA/AUDIO/AUTOSELECT/O3.Policy=<op\_mode>

**Setting the Followed Video Port to Autoselect**

- ▶ SET·/V1/MEDIA/AUDIO/AUTOSELECT/O3.VideoFollowPort=<out>

**Locking the Audio Port**

- ▶ SET·/V1/MEDIA/AUDIO/XP/<audio\_port>.Lock=<locked\_state>

**Muting the Audio Port 1.**

- ▶ SET·/V1/MEDIA/AUDIO/XP/<audio\_port>.Mute=<muted\_state>

**Muting the Audio Port 2.**

- ▶ SET·/V1/MEDIA/AUDIO/O4.Mute=<muted\_state>

**Querying the Audio Signal Presence**

- ▶ GET·/V1/MEDIA/AUDIO/<audio\_port>.SignalPresent

**Analog Audio Output Volume (dB) Setting**

- ▶ SET·/V1/MEDIA/AUDIO/<analog\_audio\_port>.VolumedB=<level>

**Analog Audio Output Volume Percent Setting**

- ▶ SET·/V1/MEDIA/AUDIO/<analog\_audio\_port>.VolumePercent=<percent>

**Setting the Balance**

- ▶ SET·/V1/MEDIA/AUDIO/<analog\_audio\_port>.Balance=<level>

**Analog Audio Output Level Setting by Steps (dB)**

- ▶ CALL·/V1/MEDIA/AUDIO/<analog\_audio\_port>:stepVolumedB(<step>)

**Analog Audio Output Level Setting by Steps in Percent**

- ▶ CALL·/V1/MEDIA/AUDIO/<analog\_audio\_port>:stepVolumePercent(<step>)

**Analog Audio Output Balance Setting by Steps**

- ▶ CALL·/V1/MEDIA/AUDIO/<analog\_audio\_port>:stepBalance(<step>)

**USB Port Settings****Switching the USB Input**

- ▶ CALL·/V1/MEDIA/USB/XP:switch(<host>:H1)

**Querying the Connected Source**

- ▶ GET·/V1/MEDIA/USB/XP/H1.ConnectedSource

**Querying the Connected Destinations**

- ▶ GET·/V1/MEDIA/USB/XP/<host>.ConnectedDestinations

**Locking the USB Port**

- ▶ SET·/V1/MEDIA/USB/XP/<usb\_port>.Lock=<locked\_state>

**Setting the 5V Sending to the USB Peripherals**

- ▶ SET·/V1/MEDIA/USB/H1/<device\_id>.Power5VMode=<device\_pwr>

**Setting the USB Autoselect Policy**

- ▶ SET·/V1/MEDIA/USB/AUTOSELECT/H1.Policy=<op\_mode>

**Setting the Followed Video Port to Autoselect**

- ▶ SET·/V1/MEDIA/USB/AUTOSELECT/H1.VideoFollowPort=<out>

**Changing the Autoselect Included USB Ports**

- ▶ SET·/V1/MEDIA/USB/AUTOSELECT/H1/<host>.Included=<state>

### Changing the USB Port Priority

- ▶ SET·/V1/MEDIA/USB/AUTOSELECT/H1/<host>.Priority=<prio\_num>

## USB Port Settings - USB-C Related Commands

### Setting the USB-C Power

- ▶ SET·/V1/MEDIA/USB/<port\_number>/POWER.Reserved=<power>

### Setting the Power Allocation Mode

- ▶ GET·/V1/MEDIA/USB/<port\_number>/POWER.AllocationMode=<allocation\_mode>

### Setting the Displayport Alternate Mode Policy

- ▶ SET·/V1/MEDIA/USB/<usb\_port>.DpAltModePolicy=<dp\_policy>

### Querying the Host Alternate Mode Support

- ▶ GET·/V1/MEDIA/USB/<usb-c\_port>.HostSupportsDpAltMode

### Querying the Status of the Alternate Mode

- ▶ GET·/V1/MEDIA/USB/<usb-c\_port>.ActiveAltMode

### Querying the Port Data Role

- ▶ GET·/V1/MEDIA/USB/<usb\_port>.ActivePortDataRole

### Querying the Port Power Role

- ▶ GET·/V1/MEDIA/USB/<usb\_port>.ActivePortPowerRole

### Setting the Port Power Role

- ▶ SET·/V1/MEDIA/USB/<usb-c\_port>.PortPowerRoleSetting=<power\_role>

## EDID Management

### Querying the Emulated EDIDs

- ▶ GET·/V1/EDID.EdidStatus

### Querying the Validity of a Dynamic EDID

- ▶ GET·/V1/EDID/D/D1.Validity

### Querying the Preferred Resolution of a User EDID

- ▶ GET·/V1/EDID/U/<user\_edid>.PreferredResolution

### Emulating an EDID to an Input Port

- ▶ CALL·/V1/EDID:switch(<source>:<destination>)

### Emulating an EDID to All Input Ports

- ▶ CALL·/V1/EDID:switchAll(<source>)

### Copying an EDID to User Memory

- ▶ CALL·/V1/EDID:copy(<source>:<destination>)

### Deleting an EDID from User Memory

- ▶ CALL·/V1/EDID:delete(<user\_edid>)

### Resetting the Emulated EDIDs

- ▶ CALL·/V1/EDID:reset()

## Ethernet Port Configuration

### Setting the DHCP State

- ▶ SET·/V1/MANAGEMENT/NETWORK.DhcpEnabled=<dhcp\_status>

### Changing the IP Address (Static)

- ▶ SET·/V1/MANAGEMENT/NETWORK.StaticIpAddress=<IP\_address>

### Changing the Subnet Mask (Static)

- ▶ SET·/V1/MANAGEMENT/NETWORK.StaticNetworkMask=<netmask>

### Changing the Gateway Address (Static)

- ▶ SET·/V1/MANAGEMENT/NETWORK.StaticGatewayAddress=<gw\_address>

### Applying the Network Settings

- ▶ CALL·/V1/MANAGEMENT/NETWORK:applySettings()

### Setting the Host name

- ▶ SET·/V1/MANAGEMENT/NETWORK.HostName=<unique\_name>

## Remote Power

### Enabling/Disabling Remote Power

- ▶ SET /V1/LINK/TX/POE/POWER.Reserved=<output\_power>

## Network Security

### Enabling/Disabling the Ethernet Port

- ▶ SET·/V1/MEDIA/ETHERNET/<ethernet\_port>.Enabled=<status>

### Querying the Service Port Number

- ▶ GET·/V1/MANAGEMENT/NETWORK/SERVICES/<port>.Port

### Enabling/Disabling the Service Port

- ▶ SET·/V1/MANAGEMENT/NETWORK/SERVICES/<port>.Enabled=<status>

### Querying the Username for Authentication

- ▶ GET·/V1/MANAGEMENT/NETWORK/AUTH/USER1.Name

### Enabling the Authentication

- ▶ SET·/V1/MANAGEMENT/NETWORK/SERVICES/<port>.AuthenticationEnabled=<status>
- ▶ CALL /V1/MANAGEMENT/NETWORK/SERVICES/HTTP:restart()

**Restarting the Network Services**

- ▶ `CALL:/V1/MANAGEMENT/NETWORK/SERVICES/<port>:restart()`

**Setting the VLAN ID**

- ▶ `SET /V1/MEDIA/ETHERNET/<port>.VlanMembership=<vlan_id>`

**Serial Port Configuration****BAUD Rate Setting**

- ▶ `SET:/V1/MEDIA/SERIAL/<serial_port>.Baudrate=<baudrate>`

**Stop Bits Setting**

- ▶ `SET:/V1/MEDIA/SERIAL/<serial_port>.StopBits=<stopbits>`

**Querying the Data Bits**

- ▶ `GET:/V1/MEDIA/SERIAL/<serial_port>.DataBits`

**Parity Setting**

- ▶ `SET:/V1/MEDIA/SERIAL/<serial_port>.Parity=<parity>`

**Sending a Message via RS-232****GPIO Port Configuration****Querying the Direction of a GPIO Pin**

- ▶ `GET:/V1/MEDIA/GPIO/<port>.Direction`

**Setting the Direction of a GPIO Pin**

- ▶ `SET:/V1/MEDIA/GPIO/<port>.Direction(<dir>)`

**Querying the Output Level of a GPIO Pin**

- ▶ `GET:/V1/MEDIA/GPIO/<port>.Output`

**Setting the Output Level of a GPIO Pin**

- ▶ `SET:/V1/MEDIA/GPIO/<port>.Output(<value>)`

**Setting the Output Level for a Specified Time**

- ▶ `CALL:/V1/MEDIA/GPIO/<port>:interval(<value>;<time>)`

**Toggling the Level of a GPIO Pin**

- ▶ `CALL:/V1/MEDIA/GPIO/<port>:toggle()`

**OCS Port Configuration****Querying the Input Level of an OCS Pin**

- ▶ `GET:/V1/MEDIA/OCS/P1.InputLevel`

**Setting the Sensor Type**

- ▶ `SET:/V1/MEDIA/OCS/P1.SensorType=<sensor_type>`

**Querying the Reported OCS State**

- ▶ `GET:/V1/MEDIA/OCS/P1.State`

# 9

## Firmware Update

This chapter is meant to help customers perform firmware updates on our products by giving a few tips on how to start and by explaining the features of the Lightware Device Updater v2 (LDU2) software. The latest software and firmware pack can be downloaded from [www.lightware.com](http://www.lightware.com).

- ▶ INTRODUCTION
- ▶ PREPARATION
- ▶ RUNNING THE SOFTWARE
- ▶ UPDATING VIA GUI

**ATTENTION!** While the firmware is being updated, the normal operation mode is suspended, as the transmitter is switched to bootload mode. Signal processing is not performed. Do not interrupt the firmware update. If any problem occurs, reboot the device and restart the process.

## 9.1. Introduction

Lightware Device Updater v2 (LDU2) software is the second generation of the LFP-based (Lightware Firmware Package) firmware update process.



LDU2

## 9.2. Preparation

Most Lightware devices can be controlled over several interfaces (e.g. Ethernet, USB, RS-232). But the firmware can be updated usually over one dedicated interface, which is the Ethernet in most cases.

If you want to update the firmware of one or more devices, you need the following:

- **LFP2 file,**
- **LDU2 software** installed on your PC or Mac.

Both can be downloaded from [www.lightware.com/downloads](http://www.lightware.com/downloads).

Optionally, you can download the **release notes** file in HTML format.

### 9.2.1. About the Firmware Package (LFP2 File)

All the necessary tools and binary files are packed into the LFP2 package file. You only need this file to do the update on your device.

- This allows the use of the same LFP2 package for different devices.
- The package contains all the necessary components, binary, and other files.
- The release notes is included in the LFP2 file, which is displayed in the window where you select the firmware package file in LDU2.

**INFO:** The size of the LFP2 file is more than 200 MB due to the components of the package. That is not a fault: Taurus runs embedded Linux inside that is necessary for the complex functions and features of the device.

### 9.2.2. LDU2 Installation

**ATTENTION!** Minimum system requirement: 2 GB RAM. The minimum display resolution is 1600x900.

**INFO:** The Windows and the Mac applications have the same look and functionality.

Download the software from [www.lightware.com/downloads](http://www.lightware.com/downloads).

#### Installation in case of Windows OS

Run the installer. If the User Account Control displays a pop-up message, click **Yes**.



#### Installation Modes

Normal install	Snapshot install
Available for Windows, MacOS and Linux	Available for Windows
The installer can update only this instance	Cannot be updated
One updateable instance may exist for all users	Many different versions can be installed for all users

**ATTENTION!** Using the default Normal install is highly recommended.

**INFO:** If you have a previously installed version, you will be prompted to remove the old version before installing the new one.

#### Installation in case of macOS

Mount the DMG file by double clicking on it, and drag the LDU2 icon over the Applications icon to copy the program into the Applications folder. If you want to copy LDU2 into another location, just drag the icon over the desired folder.

**ATTENTION!** Please check the firewall settings on the macOS device. LDC needs to be added to the exceptions of the blocked software for the proper operation.

**INFO:** This type of installer is equal to the **Normal install** of Windows.



#### Installation in case of Linux

**Step 1.** Download the **archive file** (tar.gz) from [www.lightware.com](http://www.lightware.com) and unpack it to a temp folder.

**Step 2.** Run the **install\_ldu2.sh** file in the temp folder. The script will install LDU2 into the following folder: HOME/.local/share/lightware/ldu2.

**Step 3.** The folder above will contain this file: **LightwareDeviceUpdaterV2.sh**, which can be used to start LDU2.

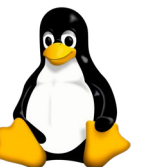

### 9.3. Running the Software

You have two options:

- **Starting the LDU2** by double-clicking on the shortcut/program file, or
- Double-clicking on an **LFP2 file**.

#### LDU2 Auto-Update

At startup, the software checks if a newer version is available on the web.

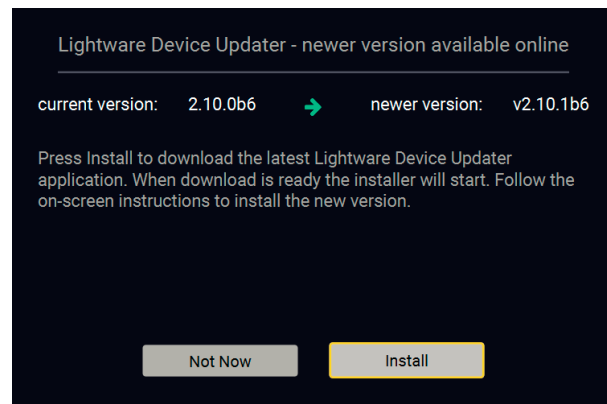

#### Main Screen

When the software is started by the shortcut, the device discovery screen appears. Press the **Discover devices** button to start finding the Lightware devices:

DISCOVER DEVICES

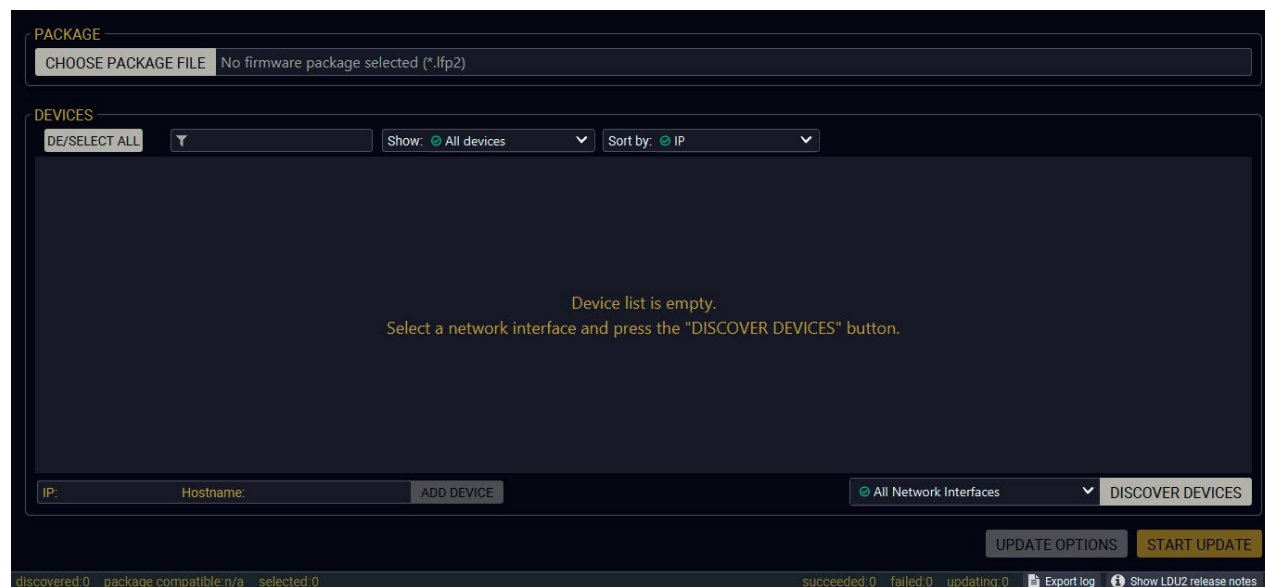

Devices may also be added manually by typing the IP address in the box near the bottom of the screen. From LDU2 version v2.16.1, manual addition of devices can also be done using the hostname.

**ATTENTION!** If the device cannot be added by the hostname, please use the IP address.

If you start the software by double-clicking on the LFP2 file, the firmware will be loaded. Press the **Search for devices** button; all the devices will be listed that are compatible with the selected firmware pack.

**INFO:** If you press the **Choose package file** button, the release notes of the LFP2 file will be displayed in the right panel; see the [Step 1. Select the Firmware Package](#) section.

#### Device List

When the discovery has completed, the devices available on the network are listed in the application.

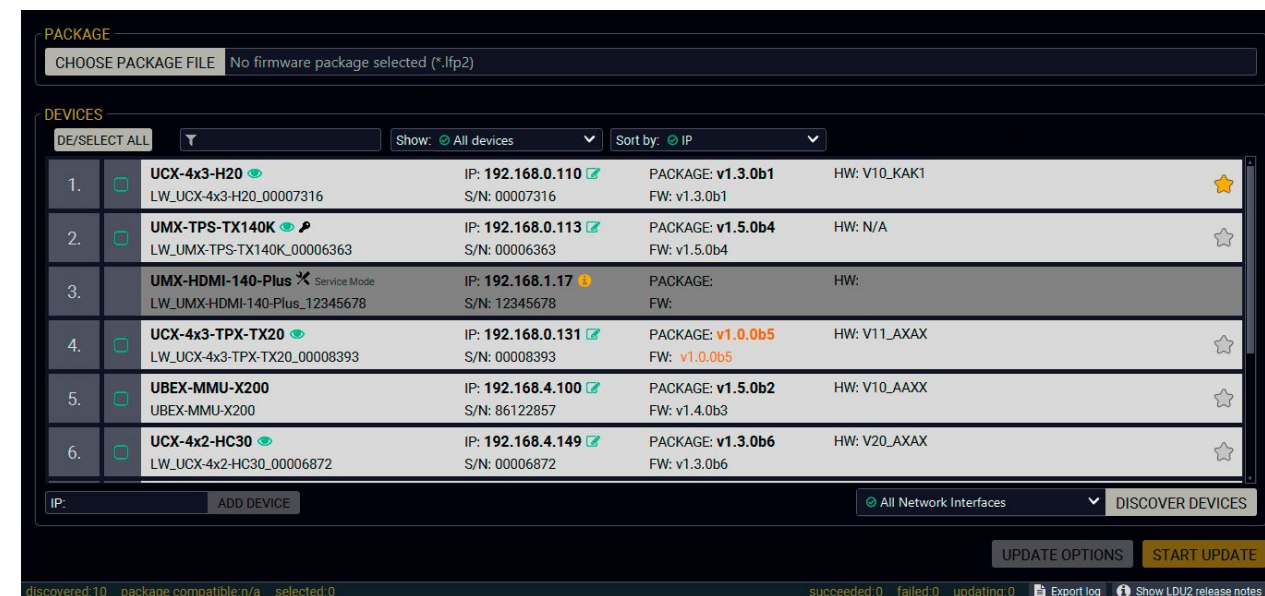

#### Legend of the Icons

- IP address editor** The IP address of the device can be changed in the pop-up window.
- Identify me** Clicking on the icon makes the front panel LEDs blink for 10 seconds, which helps identify the device physically.
- Authentication required** The password-protection is enabled. You have to enter the password to perform the firmware update in the pop-up window at the beginning of the update.
- Favorite device** The device has been marked, thus the IP address is stored. When a device is connected with that IP address, the star will be highlighted in that line.
- Further information available** Device is unreachable. Change the IP address using the front panel LCD menu or the IP address editor of the LDU2.



### 9.4. Updating Via GUI

To update the desired device(s) via the Graphical User Interface, follow these steps.

**ATTENTION!** The computer that runs LDU2 and the target device (that will be updated) must be in the same subnet. The update cannot be performed from behind a firewall or gateway.

**ATTENTION!** While the firmware is being updated, the normal operation mode is suspended, as the device is switched to bootload mode. Signal processing is not performed. Do not interrupt the firmware update. If any problem occurs, reboot the unit and restart the process.

**Device Cloning – Configuration Backup and Restore** feature supports copying all the settings from one device to another, but cloning is only possible between devices using the same firmware. Uploading of the firmware package happens on http (80) and https (443) ports, so one of them has to be enabled.

#### Step 1. Select the Firmware Package.

Click on the **Choose package file** button and navigate to the location where the LFP2 file was saved. When you click on the name of the package, the preview of the release notes is displayed in the right panel.

CHOOSE PACKAGE FILE

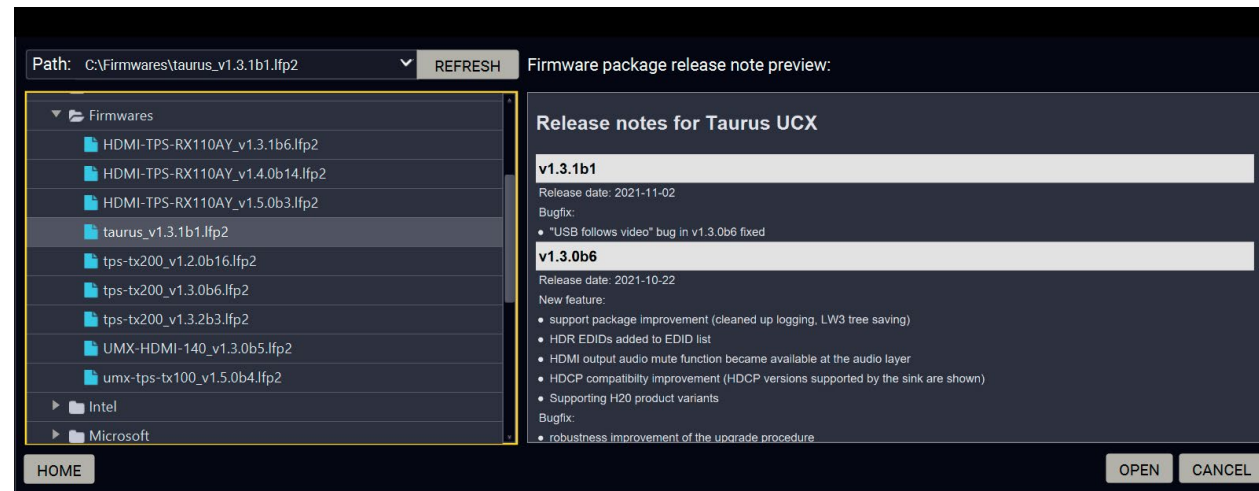

After the package file is loaded, the list is filtered to show the compatible devices only. The current firmware version of the device is highlighted in orange if it is different from the version of the package loaded.

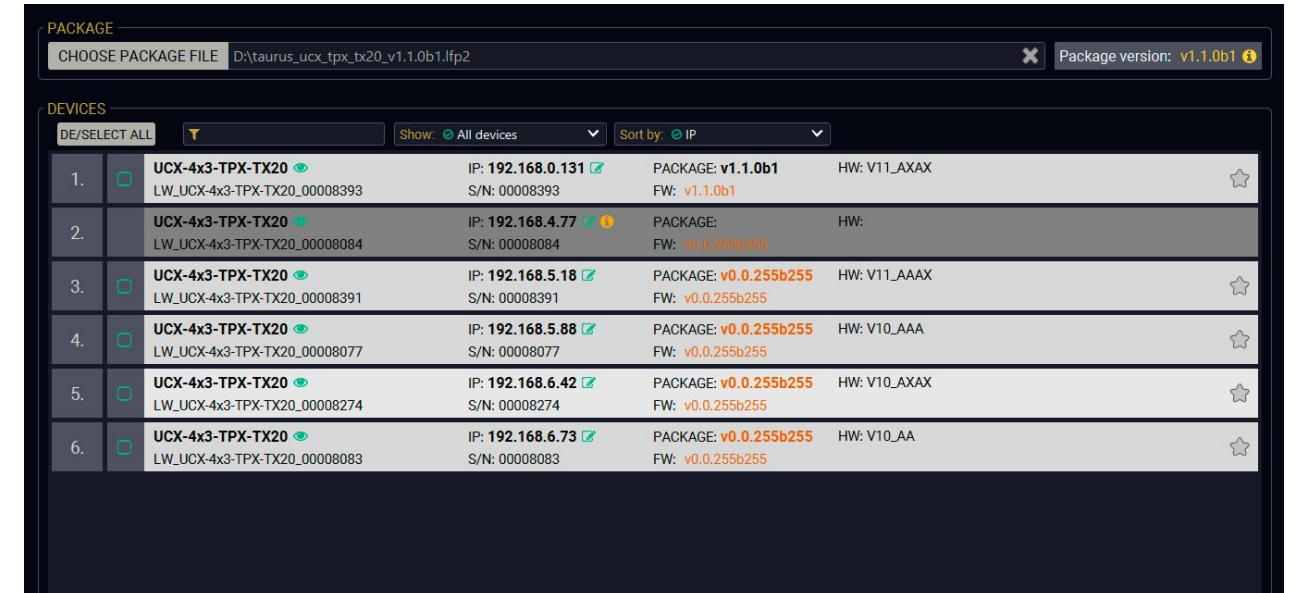

If you start the update by double-clicking on the LFP file, the screen above will be loaded right away.

#### The Meaning of the Symbols

- Show details
- Service mode

The log about the updating process of the device can be displayed in a new window.

The device is in bootload mode. Backup and restore cannot be performed in this case.

**Step 2. Select the desired devices for updating**

Select the devices for updating; the selected line will be highlighted in green.

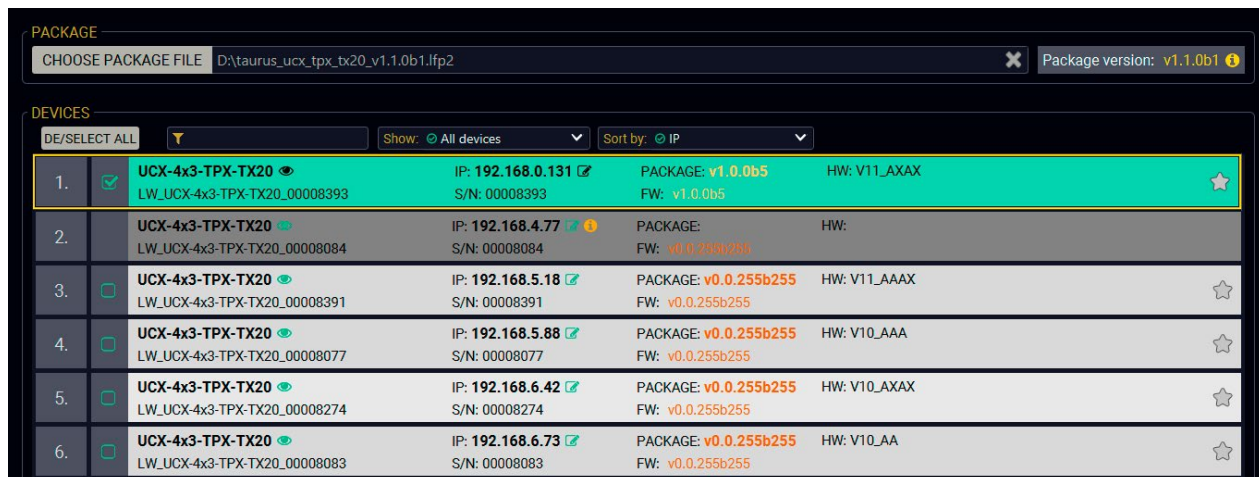

**Step 3. Start the update and wait until it is finished.**

Click on the **Start Update** button to start the procedure. The status is shown in percent in the right side of the device line and the overall process in the bottom progress bar. The device might reboot during the firmware update procedure.

**START UPDATE (1)**



When the progress bar reaches 100% (**Done** is displayed at all devices), the update of all devices are finished successfully and a message appears; you can close the software.

**Step 4. Wait until the unit reboots with the new firmware.**

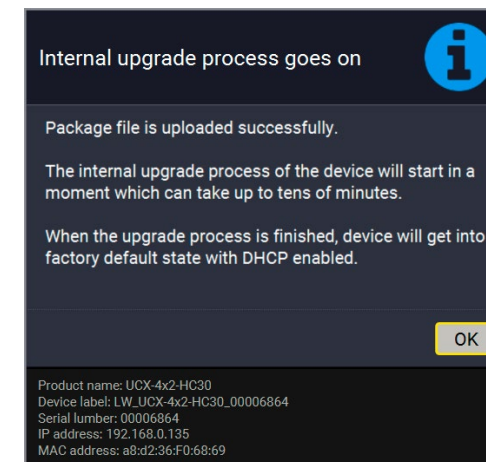

Once the firmware update procedure is completed, the device is rebooted with the new firmware. Shutting down and restarting the device is recommended.

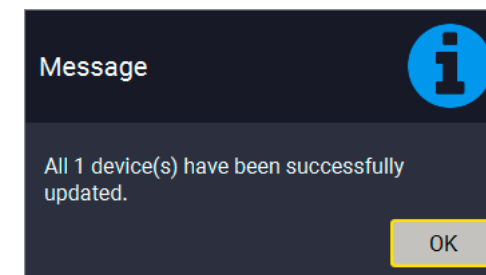





# 10

## Troubleshooting















Usually, if the system seems not to transport the signal as expected, the best strategy for troubleshooting is to check signal integrity through the whole signal chain starting from source side and moving forward to receiver end.





First, check the front panel LEDs and take the necessary steps according to their states. For more information about status LEDs, refer to the [Front Panel LEDs](#) and [Rear Panel LEDs](#) sections.



-  Link to connections/cabling section.
-  Link to device operation section.
-  Link to LDC software section.
-  Link to LW2 protocol commands section.
-  Link to LW3 protocol commands section.

- ▶ [USE CASE STUDIES](#)
- ▶ [HOW TO SPEED UP THE TROUBLESHOOTING PROCESS](#)

### 10.1. Use Case Studies

Symptom	Root cause	Action	Refer to
<b>Video layer</b>			
<b>No picture on the video output</b>	Device(s) not powered properly	Check the switcher and the other devices if they are properly powered; try to unplug and reconnect them.	 4.6
	Cable connection problem	Cables must fit very well, check all the connectors.	 4.6
	No incoming signal	No video signal is present on the HDMI input ports. Check the source device and the HDMI cables.	 4.6
	Not the proper video port is the active one	Check the video crosspoint settings.	 3.1.1
			 6.7
			 8.6.1
	Not the proper interface is the active one	If the source/display has more connectors, check if the proper interface is selected.	
	Output port is muted	Check the mute state of output ports.	 6.7.1
 8.6.4			
Display is not able to receive the video format	Check the emulated EDID and select another (e.g. emulate the display's EDID on the input port).	 6.11.1	
		 8.13.4	
HDCP is disabled	Enable HDCP on input port(s) of the switcher.	 6.8	
		 8.6.12	
<b>No picture on the video output + signal error rate is high, HDMI2.0 scrambling is disabled, clock rate is set 1:10</b>	The source sends 4K signals, but the emulated EDID does not support this resolution.	 6.11.1	
		 8.13.4	

Symptom	Root cause	Action	Refer to	
<b>No 4K60 video signal on the USB-C input</b>	The source is not able to send 4K60Hz	Check the documentation of the source and the ability of the connected port. Certain USB-C ports are only for power and not for video transmission. The icons beside the port can help.		
	The source PC or BYOD resolution is not 4K60Hz	Check the source resolution and modify it if necessary. Certain sources require restarting.		
	The USB-C cable is not appropriate	The USB-C standard allows two cable types: the Full-Featured Type-C Cable Assembly or 2.0 Type-C Cable Assembly. The latter one will not operate with 4K60Hz.	 4.5	
			Always use high-quality cables. The no-name USB 3.1 Gen1-compatible cables can use only 2 SS channels instead of 4. The minimum cable requirement is USB 3.1 Gen1-compatibility and support of Displayport HBR2.	 4.5
			The active Thunderbolt3 cable is not appropriate, because it is not compatible backwards (with USB 3.x or DP). The passive TBT3 (20Gbps) cable may be appropriate if it supports USB3 Gen1 or Gen2 and Displayport.	 4.5
<b>USB layer</b>				
<b>The USB 2.0 data transmission does not operate</b>	IR drop level of the USB Type-C cable is low.	It can cause communication problems. Always use high quality cables.	 4.5	
<b>The USB 2.0 data transmission or Power delivery do not operate</b>	If the resistor of the conductor in USB-C cable is too high, the voltage difference could be more than 0.25V, which can cause USB 2.0 or Power Delivery communication problems.	Always use high quality cables.	 4.5	

Symptom	Root cause	Action	Refer to
<b>Power via USB-C</b>			
<b>BYOD charges slowly</b>	The BYOD needs more than 60W	Make sure the Power Allocation is set to Auto or increase the minimum output power	4.3
			 6.13.5
	Not proper the power setting of the USB-C port	Check the output power setting the connected port.	 6.10.1

## 10.2. How to Speed Up the Troubleshooting Process

Lightware's technical support team is always working hard to provide the fastest support possible. Our team's response time is one of the best in the industry and in the toughest of cases we can directly consult with the hardware or software engineer who designed the product to get the information from the most reliable source.

However, the troubleshooting process can be even faster... with your help.

There are certain pieces of information that push us in the right direction to find the root cause of the problem. If we receive most of this information in the first e-mail or it is gathered at the time when you call us, then there is a pretty high chance that we will be able to respond with the final solution right away.

### This information is the following:

- Schematic (a pdf version is preferred, but a hand drawing is sufficient).
- Serial number(s) of the device(s) (it is either printed somewhere on the box or you can query it in the Device Controller software or on the built-in website).
- Firmware versions of the devices (please note that there may be multiple CPUs or controllers in the device and we need to know all of their firmware versions, a screenshot is the best option).
- Cable lengths and types (in our experience, it's usually the cable).
- Patch panels, gender changers or anything else in the signal path that can affect the transmission.
- Signal type (resolution, refresh rate, color space, deep color).
- Emulated EDID(s) (please save them as a file and send it to us).
- Actions to take in order to re-create the problem (if we cannot reproduce the problem, it is hard for us to find the cause).
- Photo or video about the problem ('image noise' can mean many different things, it's better if we see it too).
- Error logs from the Device Controller software.
- In the case of an Event Manager issue the event file and/or backup file from the Device Controller software.

The more of the information above you can give us, the better. Please send this information to the Lightware Support Team ([support@lightware.com](mailto:support@lightware.com)) to speed up the troubleshooting process.

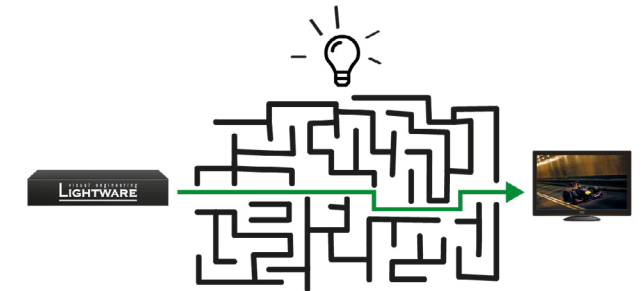

# 11

## Technologies

The following sections contain descriptions and useful technical information on how the devices work in the background. The content is based on experiences and cases we met in the practice. These sections help understand features and technical standards like the following:

- ▶ [EDID MANAGEMENT](#)
- ▶ [HDCP MANAGEMENT](#)
- ▶ [PIXEL ACCURATE RECLOCKING](#)

## 11.1. EDID Management

### 11.1.1. Understanding the EDID

The Extended Display Identification Data (EDID) is the passport of display devices (monitors, TV sets, projectors). It contains information about the capabilities of the display, such as supported resolutions, refresh rates (these are called Detailed Timings), the type and manufacturer of the display device, etc.

After connecting a source to a display (DVI, HDMI, DP), the source reads out the EDID to determine the resolution and refresh rate of the image to be transmitted.

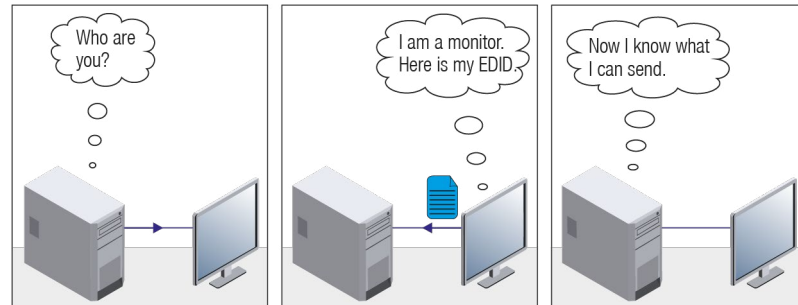

**EDID Communication**

Most DVI computer displays have a 128-byte long EDID structure. However, Digital Televisions and HDMI capable displays may have another 128 bytes, which is called E-EDID and defined by CEA (Consumer Electronics Association). This extension contains information about additional Detailed Timings, audio capabilities, speaker allocation and HDMI capabilities. It is important to know that all HDMI capable devices must have CEA extension, but not all devices with CEA extension are HDMI capable.

#### Common Problems Related to EDID

- Problem:** “My system consists of the following: a computer, a Lightware device, a WUXGA (1920x1200) LCD monitor, and an SXGA (1280x1024) projector. I would like to see the same image on the monitor and the projector. What EDID should I choose on the Lightware device?”
- Solution:** If you want to see the image on both displays, you need to select the resolution of the smaller display (in this case SXGA), otherwise the smaller display may not show the higher resolution image.
- Problem:** “I have changed to a different EDID on an input port of the Lightware device to have a different resolution, but nothing happens.”
- Solution:** Some graphics cards and video sources read out the EDID only after power-up and later they do not sense that the EDID has been changed. You need to restart your source to make it read out the EDID again.

### 11.1.2. Advanced EDID Management

Each DVI sink (e.g. monitors, projectors, plasma displays, etc...) must support the EDID data structure. Source BIOS and operating systems are likely to query the sink using DDC2B protocol to determine what pixel formats and interface are supported. The DVI standard uses EDID data structure to identify the monitor type and capabilities. Most DVI sources (VGA cards, set top boxes, etc.) will output DVI signal after accepting the connected sink's EDID information. In the case of EDID readout failure or missing EDID, the source will not output DVI video signal.

Lightware devices provide the Advanced EDID Management function that helps system integration. The built-in EDID Router can store and emulate factory pre-programmed- and User programmable EDIDs. The EDID of the attached monitors or projectors for each output is stored in a non-volatile memory. This way the EDID of a monitor is available when the monitor is unplugged or switched off.

Any EDID can be emulated on any input. An emulated EDID can be copied from the EDID router's memory (static EDID emulation), or from the last attached monitor's memory (dynamic EDID emulation). For example, the Lightware device can be set up to emulate a sink device that is connected to one of the outputs. In this case, the EDID automatically changes if the monitor is replaced with another display device (as long as it has a valid EDID).

EDID is independently programmable for all inputs without affecting each other. All inputs have their own EDID circuit.

**INFO:** The user is not required to disconnect the video cable to change an EDID as opposed to other manufacturer's products. The EDID can be changed even if a source is connected to the input and powered ON.

**INFO:** When the EDID has been changed, the router toggles the HOTPLUG signal for 2 seconds. Some sources do not sense this signal. In such cases, the source device must be restarted or powered OFF and ON again.

## 11.2. HDCP Management

Lightware Visual Engineering is a legal HDCP adopter. Several functions have been developed that help to solve HDCP related problems. Complex AV systems often have both HDCP and non-HDCP components. The matrix allows transmitting HDCP encrypted and unencrypted signals. The devices will be still HDCP compliant, as they will never output an encrypted signal to a non-HDCP compliant display device. If an encrypted signal is switched to a non-compliant output, a red screen alert or muted screen will appear.

### 11.2.1. Protected and Unprotected Content

Many video sources send HDCP protected signal if they detect that the sink is HDCP capable – even if the content is not copyrighted. This can cause trouble if an HDCP capable device is connected between the source and the display. In this case, the content cannot be viewed on non-HDCP capable displays and interfaces like event controllers. Rental and staging technicians often complain about certain laptops that always send HDCP encrypted signals if the receiver device (display, matrix router, etc.) reports HDCP compliancy. However, HDCP encryption is not required all the time (e.g. computer desktop image), certain laptops still do that.

To avoid unnecessary HDCP encryption, Lightware introduced the HDCP enabling/disabling function: the HDCP capability can be disabled in the Lightware device. If HDCP is disabled, the connected source will detect that the sink is not HDCP capable, and turn off authentication.

### 11.2.2. Disable Unnecessary Encryption

#### HDCP Compliant Sink

All the devices are HDCP-compliant, no manual setting is required, both protected and unprotected contents are transmitted and displayed on the sink.



#### Not HDCP-compliant Sink 1.

Not-HDCP compliant sink is connected to the matrix. Some sources (e.g. computers) always send HDCP encrypted signals if the receiver device reports HDCP compliancy, however, HDCP encryption is not required all the time (e.g. computer desktop image). If HDCP is enabled in the matrix, the image will not be displayed on the sink.



Setting the HDCP parameter to Auto on the output port and disabling HDCP on the input port, the transmitted signal will not be encrypted if the content is not protected. Thus, non-HDCP compliant sinks will display non-encrypted signal.

#### Not HDCP-compliant Sink 2.

The layout is the same as in the previous case: non-HDCP compliant display device is connected to the matrix, but the source would send protected content with encryption. If HDCP is enabled on the input port of the matrix, the source will send encrypted signal.



The sink is not HDCP compliant, thus it will not display the video signal (but blank/red/muted/etc. screen). If HDCP is disabled on the input port of the matrix, the source will not send the signal. The solution is to replace the display device with an HDCP-capable one.



### 11.2.3. HDCP 2.2

HDCP 2.2 is the latest evolution of copy protection. It is designed to create a secure connection between a source and a display. The 2.x version of HDCP is not a continuation of HDCPv1, and is rather a completely different link protection. One of the main differences is the number of the allowed devices within a closed AV system: HDCP 2.2 allows 32 devices (HDCP 1.4 allows 128 devices). Further limit is that up to four level is allowed, which means the protected signal can be transmitted over at most four repeater/matrix/switcher device. HDCP content protection is activated only if an active video stream is transmitted from the source to the display. The encryption is not activated without a video signal.

HDCP 2.2 standard allows to apply a previous version of HDCP (e.g. HDCP 1.4) between the source and the display if the source device allows it. According to the standard, if the image content is protected with HDCP, the highest supported content protection level has to be applied. However, if the highest level of protection is not justified by the source content, the level may be decreased to avoid compatibility problems; this case is determined by the source.

#### HDCP 2.2 Source and HDCP 1.4 Sink

In this case the signal of an HDCP 2.2 compliant source is switched to an HDCP 1.4 compliant sink device. The signal is encrypted with HDCP 2.2 on the input and encrypted with HDCP 1.4 on the output of the Lightware device. A lower level of encryption may be applied only if the source device/content allows it - according to the HDCP standard. In this case the HDCP setting on the input port has to be set to HDCP 1.4 and Depends on input on the output port.



#### HDCP 1.4 Source and HDCP 2.2 Sink

The example below is the reversal of the previous case. An HDCP 1.4 compliant source sends a signal with HDCP 1.4 encryption. The signal is switched to an HDCP 2.2 compliant sink device. In this case the outgoing signal has to be encrypted with the highest supported encryption level towards the sink, as the Lightware device and the sink are both HDCP 2.2 compliant. The HDCP 2.2 standard does not allow keeping the original HDCP 1.4 encryption level on the output.



#### What Kind of Signal Will be on the Output of the Lightware Device?

See the table below summarizing the possible cases:

Incoming Signal	HDCP 1.4 Compatible Sink on the Output	HDCP 2.2. Compatible Sink on the Output
HDCP 1.4	HDCP 1.4	HDCP 2.2
HDCP 2.2 (convertable)*	HDCP 1.4	HDCP 2.2
HDCP 2.2 (not convertable)**	Red screen	HDCP 2.2

\* Stream type 0: the video stream allows to convert the signal to apply a lower level of encryption.

\*\* Stream type 1: the video stream does not allow to convert the signal.

### 11.3. Pixel Accurate Reclocking

Signal reclocking is an essential procedure in digital signal transmission. After passing the reclocking circuit, the signal becomes stable, jitter-free, and can be transmitted over more equipment like processors or event controllers. Without reclocking, sparkles, noise, and jaggies appear on the image.

Lightware's sophisticated Pixel Accurate Reclocking technology fixes more problems than general TMDS reclocking. It removes not only intra-pair skew, but inter-pair skew as well. The Pixel Accurate Reclocking circuit eliminates the following errors:

#### Intra-pair skew

Skew between the + and - wires within a differential wire pair (e.g. Data2- and Data2+). It's caused by different wire lengths or slightly different wire construction (impedance mismatch) in the DVI cable. It results in jitter.

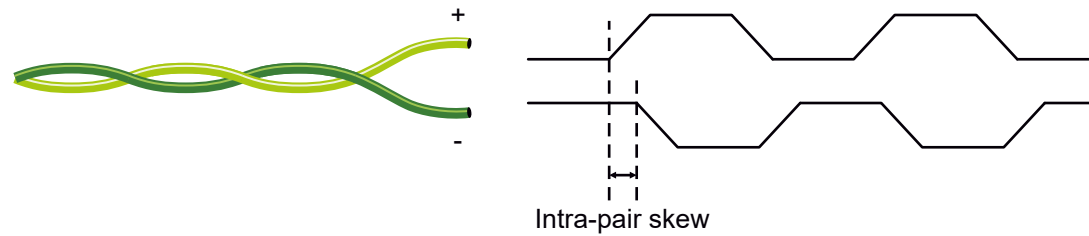

#### Inter-pair skew

Skew between two differential wire pairs in a cable. It is caused by different wire pair lengths or different number of twists in the DVI cable. Too much inter-pair skew results in color shift in the picture or sync loss.

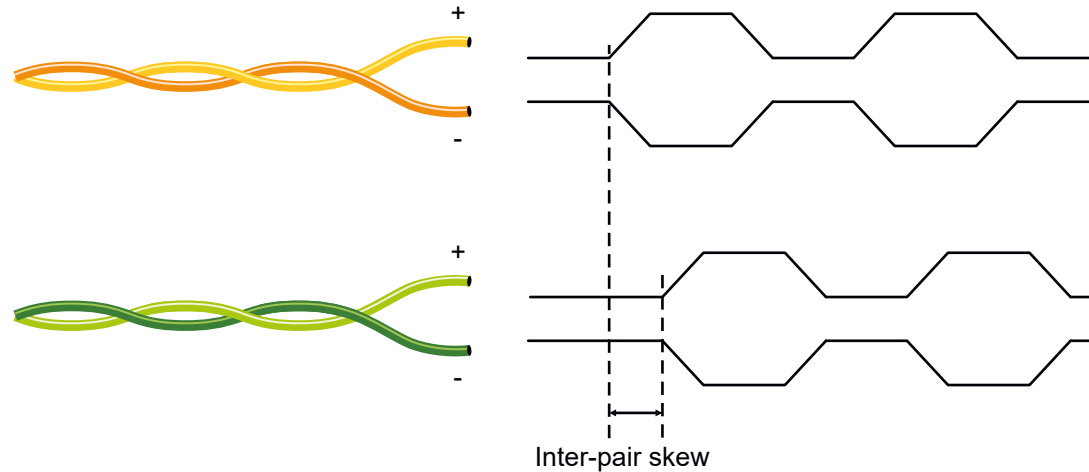

#### Jitter

Signal instability in the time domain. The time difference between two signal transitions should be a fixed value, but noise and other effects cause variations.

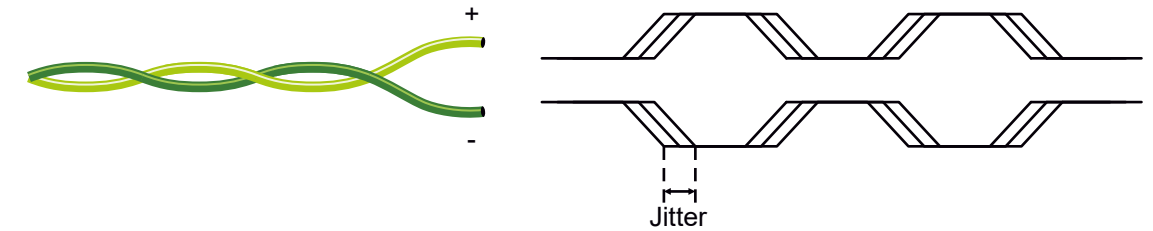

#### Noise

Electromagnetic interference between other electronic devices such as mobile phones, motors, etc. and the DVI cable are coupled onto the signal. Too much noise results in increased jitter.

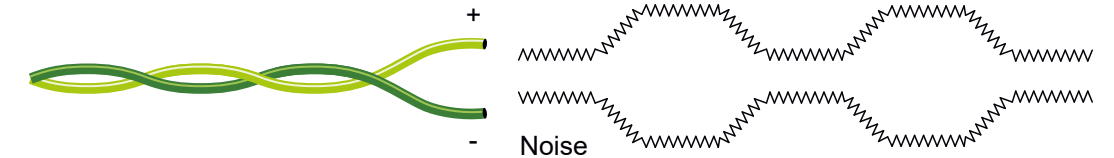

# 12

## Appendix

Tables, drawings, guides, technical details and hashtag keyword list as follows:

- ▶ SPECIFICATIONS
- ▶ PORT NUMBERING
- ▶ APPLIED PORTS (NETWORK SETTINGS)
- ▶ FACTORY EDID LIST
- ▶ CABLE WIRING GUIDE
- ▶ FACTORY DEFAULT SETTINGS
- ▶ CONTENT OF THE BACKUP FILE
- ▶ MECHANICAL DRAWINGS
- ▶ FIRMWARE RELEASE NOTES FOR UCX-TX DEVICES
- ▶ FIRMWARE RELEASE NOTES FOR UCX-TPX-RX DEVICES
- ▶ FIRMWARE RELEASE NOTES FOR HDMI-TPX-RX DEVICES
- ▶ HASHTAG KEYWORD LIST
- ▶ FURTHER INFORMATION

## 12.1. Specifications

### 12.1.1. UCX-4x3-TPX-TX20, UCX-2x1-TPX-TX20, UCX-3x3-TPX-RX20

#### General

Compliance	CE, UKCA
Electrical safety	EN 62368-1:2020
EMC (emission)	EN 55032:2015+A1:2020
EMC (immunity)	EN 55035:2017+A11:2020
RoHS	EN 63000:2018
Warranty	3 years
Operating temperature	0° to +50°C (+32° to +122°F)
Operating humidity	10% to 90%, non-condensing
Cooling	Cooling fan

#### Power (UCX-4x3-TPX-TX20)

Power supply option	External 220W Power Supply (if remote powering HDMI-UCX-TPX-RX107)
Supported power source	100-240 V AC; 50/60 Hz
AC power plug	Interchangeable (EZ, UK, JP/US, AUS/NZ)
Battery cell type	BR1632A
Power consumption <sup>1</sup>	183.3 W (max, measured)
Heat dissipation <sup>1</sup>	625.5 BTU/h (max)

<sup>1</sup> The power consumption and heat dissipation results were measured with UCX-4x3-TPX-TX20 and HDMI-UCX-TPX-RX107 together.

#### Power (UCX-2x1-TPX-TX20)

Power supply option	External 160W Power Supply
Supported power source	100-240 V AC; 50/60 Hz
AC power plug	Interchangeable (EZ, UK, JP/US, AUS/NZ)
Battery cell type	BR1632A
Power consumption (without PoE)	127 W (max, measured)
Heat dissipation	433.3 BTU/h (max)

#### Power (UCX-3x3-TPX-RX20)

Power supply option	External 80W Power Supply
Supported power source	100-240 V AC; 50/60 Hz
AC power plug	Interchangeable (EZ, UK, JP/US, AUS/NZ)

Battery cell type	BR1632A
Power consumption	9 W (max, measured)
Heat dissipation	30.7 BTU/h (max)

#### Enclosure

Rack mountable	yes
Enclosure material	1 mm steel
Dimensions - Transmitters (mm)	271 W x 140.3 D x 26 H
Dimensions - UCX-3x3-TPX-RX20 (mm)	246 W x 140.3 D x 26 H
Dimensions - Transmitters (inch)	10.7 W x 5.57 D x 1.01 H
Dimensions - UCX-3x3-TPX-RX20 (inch)	9.69 W x 5.57 D x 1.01 H
Weight - Transmitters	1050 g (2.31 lb)
Weight - UCX-3x3-TPX-RX20	936 g (2.06 lb)

#### Video inputs

##### USB-C input (only for UCX-4x3-TPX-TX20 and UCX-2x1-TPX-TX20)

Connector type	24-pole USB type C receptacle
AV standard	DP 1.2a
HDCP compliance	HDCP 1.4, HDCP 2.2
Color space	RGB, YCbCr
Video delay	0 frame
Max. video resolution	4096x2160@60Hz RGB 4:4:4 (up to 600MHz pixel clock); 1920x1080@120Hz, 36 bit
Audio formats	all formats in line with HDMI 2.0 standard
3D support	yes

##### TPX input (only for UCX-3x3-TPX-RX20)

Connector type	RJ45 connector
Power over Ethernet	Not supported
Data rate	10GBase-T
Compliance	AVXT
HDCP compliance	HDCP 2.3
Transferred signals	Video, Audio, USB 2.0, RS-232, Ethernet
Color space	RGB, YCbCr
Supported resolutions at 8bits/color	up to 4096x2160@60Hz 4:4:4
Audio formats	8-channel PCM, Dolby TrueHD, DTS-HD Master Audio 7.1

**HDMI input**

Connector type	19-pole HDMI Type A receptacle (with screw locking option)
AV standard	DVI 1.0; HDMI 1.4; HDMI 2.0
Maximum data rate	18Gbps
Maximum pixel clock	597MHz
HDCP compliance	HDCP 1.4; HDCP 2.2
Color space	RGB, YCbCr
Video delay	0 frame
Max. video resolution	4096x2160@60Hz RGB 4:4:4 (up to 600MHz pixel clock); 1920x1080@120Hz, 36 bit
Max. input HDMI cable length (with premium certified cable) at 3840x2160@60Hz 4:4:4	5m
Re-clocking	Pixel Accurate Re-clocking
3D support	yes
Audio mode	simultaneous pass-through and de-embedding to the Audio layer
Supported audio formats for pass-through	All HDMi 2.0 audio formats
Supported audio formats for de-embedding	Uncompressed
Compressed	Dolby Digital, DTS; Compressed HBR; Dolby TrueHD; DTS-HD

**Video Outputs****TPX output (only for UCX-4x3-TPX-TX20 and UCX-2x1-TPX-TX20)**

Connector type	RJ45 connector
Power over Ethernet	POE+ PSE (IEEE802.3at)
Data rate	10GBase-T
Compliance	AVXT
HDCP compliance	HDCP 2.3
Transferred signals	Video, Audio, USB 2.0, RS-232, Ethernet
Color space	RGB, YCbCr
Supported resolutions at 8bits/color	up to 4096x2160@60Hz 4:4:4
Audio formats	8-channel PCM, Dolby TrueHD, DTS-HD Master Audio 7.1

**HDMI output**

Connector type	19-pole HDMI Type A receptacle (with screw locking option)
----------------	--

AV standard	DVI 1.0; HDMI 1.4; HDMI 2.0
HDCP compliance	HDCP 1.4, HDCP 2.2
Color space	RGB, YCbCr
Supported resolutions	up to UHD/4K@60Hz 4:4:4
Audio formats	8-channel PCM, Dolby TrueHD, DTS-HD Master Audio 7.1

**Audio Ports****Analog audio output**

Connector type	5-pole Phoenix connector
Audio formats	2-ch PCM
Sampling frequency	48kHz
Volume	-95.62 dB-0 dB
Balance	-100 - +100 (0 is center)

**Control ports****USB ports**

Connector type	A-type receptacle
USB compliance	USB 2.0
Connector type	mini B-type
USB compliance	USB 2.0
Connector type	B-type receptacle
USB compliance	USB 2.0

**Ethernet ports**

Connector type	RJ45 female connector
Ethernet data rate	10/100/1000 Base-T, full duplex with auto detect
Power over ethernet (PoE)	Not supported

**RS-232 ports**

Connector type	3-pole Phoenix connector
Baud rates	between 9600 and 115200 baud
Data bits	8
Parity	None, Odd/Even
Stop bits	1/2
Output voltage: Low level	3V to 15V
Output voltage: High level	-15V to -3V

**GPIO ports**

Connector type	8-pole Phoenix connector
Function (pin 1-6)	Configurable (input/output)
Function (pin 7)	5V output
Function (pin 8)	Ground

**OCS port (only for UCX-3x3-TPX-RX20)**

Connector type	3-pole Reversed Gender Plug Phoenix connector
Number of configurable pins	1
Port direction	Input

INFO: The -LCC models have the same values as non-LCC models.

**12.1.2. HDMI-UCX-TPX-RX107****General**

Compliance	CE, UKCA
Electrical safety	EN 62368-1:2020
EMC (emission)	EN 55032:2015+A1:2020
EMC (immunity)	EN 55035:2017+A11:2020
RoHS	EN 63000:2018
Warranty	3 years
Operating temperature	0° to +50°C (+32° to +122°F)
Operating humidity	10% to 90%, non-condensing
Cooling	Passive

**Power**

Power supply option	Power adaptor 12V / PoE+ PD
Supported power source	100-240 V AC, 50/60 Hz
Power consumption <sup>1</sup>	183.3 W (max, measured)
Heat dissipation <sup>1</sup>	625.5 BTU/h (max)

<sup>1</sup> The power consumption and heat dissipation results were measured with UCX-4x3-TPX-TX20 and HDMI-UCX-TPX-RX107 together.

**Power adaptor**

Supplied power	12V DC, 2A
AC power plug	Interchangeable (EZ, UK, JP/US, AUS/NZ)
DC power plug	Locking DC connector (2.1/5.5 mm pin)

**Enclosure**

Rack mountable	yes, with mounting accessories
Enclosure material	1 mm steel
Dimensions (mm)	151.8 W x 104.9 D x 26 H
Dimensions (inch)	5.98 W x 4.13 D x 1.01 H
Weight	532 g (1.2 lb)

**Video inputs****TPX input**

Connector type	RJ45 connector
Power over Ethernet	POE+ PD (IEEE802.3at)
Data rate	10GBase-T
Compliance	AVXT
HDCP compliance	HDCP 2.3
Transferred signals	Video, Audio, USB 2.0, RS-232, Ethernet
Color space	RGB, YCbCr
Supported resolutions at 8bits/color	up to 4096x2160@60Hz 4:4:4
Audio formats	8-channel PCM, Dolby TrueHD, DTS-HD Master Audio 7.1

**Video Outputs****HDMI output**

Connector type	19-pole HDMI Type A receptacle (with screw locking option)
AV standard	DVI 1.0, HDMI 2.0
HDCP compliance	HDCP 2.3
Color space	RGB, YCbCr
Supported resolutions at 8bits/color	up to 4096x2160@60Hz 4:4:4
Audio formats	8-channel PCM, Dolby TrueHD, DTS-HD Master Audio 7.1

**Audio Ports****Analog audio output**

Connector type	5-pole Phoenix connector
Audio formats	2-ch PCM
Sampling frequency	48kHz
Signal transmission	balanced signals

**Control ports****USB ports**

Connector type	A-type receptacle
USB compliance	USB 2.0

**Ethernet ports**

Connector type	RJ45 female connector
Ethernet data rate	1GBase-T, full duplex with autodetect

**OCS port**

Connector type	3-pole Reversed Gender Plug Phoenix connector
Number of configurable pins	1
Port direction	Input

**RS-232 ports**

Connector type	3-pole Phoenix connector
Baud rates	between 9600 and 115200 baud
Data bits	8
Parity	None, Odd/Even
Stop bits	1/2
Output voltage: Low level	3V to 15V
Output voltage: High level	-15V to -3V

INFO: Specifications are subject to change without notice.

## 12.2. Port Numbering

INFO: The -LCC models have the same values as non-LCC models.

### Audio/Video Ports

Model name		UCX-4x3-TPX-TX20		UCX-2x1-TPX-TX20		UCX-3x3-TPX-RX20	
Port name		Video port nr. (LW3)	Audio port nr. (LW3)	Video port nr. (LW3)	Audio port nr. (LW3)	Video port nr. (LW3)	Audio port nr. (LW3)
Inputs	AVX in 1	-	-	-	-	I1	I1
	USB-C in 1	I1	I1	I1	I1	-	-
	USB-C in 2	I2	I2	-	-	-	-
	HDMI in 3	I3	I3	I2	I2	I2	I2
	HDMI in 4	I4	I4	-	-	I3	I3
	Welcome Screen	I5	-	I5	-	I5	-
Outputs	AVX out 1	O1	O1	O1	O1	-	-
	HDMI out 1	O2	O2	-	-	O1	O1
	HDMI out 2	O3	O3	-	-	O2	O2
	HDMI out 3	-	-	-	-	O3	O3
	Analog audio out	-	O4	-	O2	-	O4
	Remote audio out	-	O5	-	O3	-	-

### USB Ports

Model name		UCX-4x3-TPX-TX20	UCX-2x1-TPX-TX20	UCX-3x3-TPX-RX20
Port name		USB port nr. (LW3)		
Upstream Facing Ports	USB-C Host 1	U1	U1	-
	USB-C Host 2	U2	-	-
	USB-B Host 3	U3	U2	U1
	USB-B Host 4	U4	-	U2
USB Hub/ Downstream Port	USB hub	H1	H1	H1
	USB Device 1	D1	D1	D1
	USB Device 2	D2	D2	D2
	USB Device 3	D3	D3	D3
	USB Device 4	D4	D4	D4

### Ethernet Ports

Port name	USB port nr. (LW3)
Ethernet 1	P1
Ethernet 2	P2
Ethernet 3	P3
USB-C in1 (Eth)	P4
USB-C in2 (Eth)	P5

### GPIO

Port name	Port nr. (LW3)
GPIO1	P1
GPIO2	P2
GPIO3	P3
GPIO4	P4
GPIO5	P5
GPIO6	P6

### OCS (UCX-3x3-TPX-RX20, HDMI-UCX-TPX-RX107)

Port name	Port nr. (LW3)
OCS1	P1

### RS-232 Ports

Port name	Port nr. (LW3)	Serial over IP port nr.
RS-232 1	P1	8001
RS-232 2	P2	8002
1	P3	8003

## 12.3. Applied Ports (Network Settings)

The following ports are necessary to pass via a network switch/firewall for a proper working between the device and the software:

Purpose/function	Protocol	Port nr.
Firmware update TFTP	UDP	69
	UDP	49990
	UDP	49995
Device Discovery	UDP	224.0.0.251:5353
Remote IP	UDP	230.76.87.82:37421
HTTP - file transfer and update API	TCP	80
HTTPS - file transfer and update API	TCP	443
LW3 control API	TCP	6107



## 12.5. Factory EDID List

Mem	Resolution	Type	EDID features
F1	640 x 480p @ 60.00 Hz	D	DVI
F2	848 x 480p @ 60.00 Hz	D	DVI
F3	800 x 600p @ 60.32 Hz	D	DVI
F4	1024 x 768p @ 60.00 Hz	D	DVI
F5	1280 x 768p @ 50.00 Hz	D	DVI
F6	1280 x 768p @ 59.94 Hz	D	DVI
F7	1280 x 768p @ 75.00 Hz	D	DVI
F8	1360 x 768p @ 60.02 Hz	D	DVI
F9	1280 x 1024p @ 50.00 Hz	D	DVI
F10	1280 x 1024p @ 60.02 Hz	D	DVI
F11	1280 x 1024p @ 75.02 Hz	D	DVI
F12	1400 x 1050p @ 50.00 Hz	D	DVI
F13	1400 x 1050p @ 60.00 Hz	D	DVI
F14	1400 x 1050p @ 75.00 Hz	D	DVI
F15	1680 x 1050p @ 60.00 Hz	D	DVI
F16	1920 x 1080p @ 50.00 Hz	D	DVI
F17	1920 x 1080p @ 60.00 Hz	D	DVI
F18	2048 x 1080p @ 50.00 Hz	D	DVI
F19	2048 x 1080p @ 60.00 Hz	D	DVI
F20	1600 x 1200p @ 50.00 Hz	D	DVI
F21	1600 x 1200p @ 60.00 Hz	D	DVI
F22	1920 x 1200p @ 50.00 Hz	D	DVI
F23	1920 x 1200p @ 59.56 Hz	D	DVI
F24	2048 x 1200p @ 59.96 Hz	D	DVI
F29	1920 x 1080p @ 60.00 Hz	U	DVI
F30	1440 x 480i @ 60.05 Hz	H	HDMI; YUV444; YUV422; 2CH_AUD
F31	1440 x 576i @ 50.08 Hz	H	HDMI; YUV444; YUV422; 2CH_AUD
F32	640 x 480p @ 59.95 Hz	H	HDMI; YUV444; YUV422; 2CH_AUD
F33	720 x 480p @ 59.94 Hz	H	HDMI; YUV444; YUV422; 2CH_AUD
F34	720 x 576p @ 50.00 Hz	H	HDMI; YUV444; YUV422; 2CH_AUD

Mem	Resolution	Type	EDID features
F35	1280 x 720p @ 50.00 Hz	H	HDMI; YUV444; YUV422; 2CH_AUD
F36	1280 x 720p @ 60.00 Hz	H	HDMI; YUV444; YUV422; 2CH_AUD
F37	1920 x 1080i @ 50.04 Hz	H	HDMI; YUV444; YUV422; 2CH_AUD
F38	1920 x 1080i @ 50.00 Hz	H	HDMI; YUV444; YUV422; 2CH_AUD
F39	1920 x 1080i @ 60.05 Hz	H	HDMI; YUV444; YUV422; 2CH_AUD
F40	1920 x 1080i @ 60.05 Hz	H	HDMI; YUV444; YUV422; 2CH_AUD
F41	1920 x 1080p @ 24.00 Hz	H	HDMI; YUV444; YUV422; 2CH_AUD
F42	1920 x 1080p @ 25.00 Hz	H	HDMI; YUV444; YUV422; 2CH_AUD
F43	1920 x 1080p @ 30.00 Hz	H	HDMI; YUV444; YUV422; 2CH_AUD
F44	1920 x 1080p @ 50.00 Hz	H	HDMI; YUV444; YUV422; 2CH_AUD
F45	1920 x 1080p @ 59.94 Hz	H	HDMI; YUV444; YUV422; 2CH_AUD
F46	1920 x 1080p @ 60.00 Hz	H	HDMI; YUV444; YUV422; 2CH_AUD
F47	1920 x 1080p @ 60.00 Hz	U	HDMI; YUV444; YUV422; 2CH_AUD
F48	1920 x 1080p @ 60.00 Hz	U	HDMI; YUV444; YUV422; 8CH_AUD
F49	1920 x 1080p @ 60.00 Hz	U	HDMI; YUV444; YUV422; DC30; DC36; YUVDC; 8CH_AUD
F98	1280 x 720p @ 60.00 Hz	H	HDMI; YUV444; YUV422; 2CH_AUD; 3D
F99	1920 x 1080p @ 60.00 Hz	H	HDMI; YUV444; YUV422; 2CH_AUD; 3D
F100	1024 x 768p @ 60.00 Hz	H	HDMI; YUV444; YUV422; 2CH_AUD
F101	1280 x 1024p @ 50.00 Hz	H	HDMI; YUV444; YUV422; 2CH_AUD
F102	1280 x 1024p @ 60.02 Hz	H	HDMI; YUV444; YUV422; 2CH_AUD
F103	1280 x 1024p @ 75.02 Hz	H	HDMI; YUV444; YUV422; 2CH_AUD
F104	1600 x 1200p @ 50.00 Hz	H	HDMI; YUV444; YUV422; 2CH_AUD
F105	1600 x 1200p @ 60.00 Hz	H	HDMI; YUV444; YUV422; 2CH_AUD
F106	1920 x 1200p @ 59.56 Hz	H	HDMI; YUV444; YUV422; 2CH_AUD
F107	2560 x 1440p @ 59.95 Hz	H	HDMI; YUV444; YUV422; 2CH_AUD
F108	2560 x 1600p @ 59.86 Hz	H	HDMI; YUV444; YUV422; 2CH_AUD
F109	3840 x 2400p @ 24.00 Hz	H	HDMI; YUV444; YUV422; 2CH_AUD
F110	3840 x 2160p @ 24.00 Hz	H	HDMI; YUV444; YUV422; 2CH_AUD
F111	3840 x 2160p @ 25.00 Hz	H	HDMI; YUV444; YUV422; 2CH_AUD

Mem	Resolution	Type	EDID features
F112	3840 x 2160p @ 30.00 Hz	H	HDMI; YUV444; YUV422; 2CH_AUD
F118	3840 x 2160p @ 30.00 Hz	U	HDMI; YUV444; YUV422; 2CH_AUD
F119	3840 x 2160p @ 30.00 Hz	U	HDMI; YUV444; YUV422; 8CH_AUD
F120	3840 x 2160p @ 60.00 Hz	H	HDMI; YUV444; YUV422; YUV420; 2CH_AUD
F121	1440 x 1080p @ 59.91 Hz	H	HDMI; YUV444; YUV422; 2CH_AUD
F122	2560 x 2048p @ 59.98 Hz	H	HDMI; YUV444; YUV422; 2CH_AUD
F123	1280 x 800p @ 59.91 Hz	H	HDMI; YUV444; YUV422; 2CH_AUD
F124	1440 x 900p @ 59.90 Hz	H	HDMI; YUV444; YUV422; 2CH_AUD
F125	1366 x 768p @ 60.00 Hz	H	HDMI; YUV444; YUV422; 2CH_AUD
F126	1600 x 900p @ 59.98 Hz	H	HDMI; YUV444; YUV422; 2CH_AUD
F127	2048 x 1080p @ 60.00 Hz	H	HDMI; YUV444; YUV422; 2CH_AUD
F128	2560 x 1080p @ 60.00 Hz	H	HDMI; YUV444; YUV422; 2CH_AUD
F129	3440 x 1440p @ 24.99 Hz	H	HDMI; YUV444; YUV422; 2CH_AUD
F130	3440 x 1440p @ 29.99 Hz	H	HDMI; YUV444; YUV422; 2CH_AUD
F131	4096 x 2160p @ 25.00 Hz	H	HDMI; YUV444; YUV422; 2CH_AUD
F132	4096 x 2160p @ 30.00 Hz	H	HDMI; YUV444; YUV422; 2CH_AUD
F133	4096 x 2160p @ 60.00 Hz	4	HDMI; YUV444; YUV422; YUV420; 2CH_AUD
F134	3440 x 1440p @ 23.99 Hz	H	HDMI; YUV444; YUV422; 2CH_AUD
F135	4096 x 2160p @ 24.00 Hz	H	HDMI; YUV444; YUV422; 2CH_AUD
F136	3840 x 2400p @ 29.99 Hz	H	HDMI; YUV444; YUV422; 2CH_AUD
F137	3840 x 2160p @ 60.00 Hz	H	HDMI; HDMI2; YUV444; YUV422; 2CH_AUD
F138	3840 x 2160p @ 50.00 Hz	H	HDMI; HDMI2; YUV444; YUV422; 2CH_AUD
F139	3840 x 2160p @ 60.00 Hz	H	HDMI; HDMI2; YUV444; YUV422; YUV420; 2CH_AUD
F140	3840 x 2160p @ 60.00 Hz	H	HDMI; HDMI2; YUV444; YUV422; YUV420; 8CH_AUD
F141	4096 x 2160p @ 60.00 Hz	H	HDMI; HDMI2; YUV444; YUV422; 2CH_AUD
F142	4096 x 2160p @ 50.00 Hz	H	HDMI; HDMI2; YUV444; YUV422; 2CH_AUD
F143	4096 x 2160p @ 60.00 Hz	H	HDMI; HDMI2; YUV444; YUV422; YUV420; 2CH_AUD
F144	4096 x 2160p @ 60.00 Hz	H	HDMI; HDMI2; YUV444; YUV422; YUV420; 8CH_AUD
F145	2560 x 2048p @ 49.97 Hz	H	HDMI; YUV444; YUV422; 2CH_AUD
F146	3840 x 2160p @ 60.00 Hz	H	HDMI; HDMI2; YUV420; DC30; DC36; YUVDC; YUV420_DC30; YUV420_DC36; 2CH_AUD; HDR

Mem	Resolution	Type	EDID features
F147	3840 x 2160p @ 60.00 Hz	H	HDMI; HDMI2; YUV444; YUV422; 2CH_AUD
F148	3840 x 2160p @ 60.00 Hz	H	HDMI; HDMI2; YUV444; YUV422; 8CH_AUD
F154	3840 x 2160p @ 60.00 Hz	H	HDMI; HDMI2; YUV444; YUV422; YUV420; DC30; DC36; YUVDC; YUV420_DC30; YUV420_DC36; 2CH_AUD; HDR
F155	3840 x 2160p @ 60.00 Hz	H	HDMI; HDMI2; YUV444; YUV422; YUV420; DC30; DC36; YUVDC; YUV420_DC30; YUV420_DC36; 8CH_AUD; HDR

#### Legend

**D:** DVI EDID

**H:** HDMI EDID

**U:** Universal EDID, supporting many standard resolutions:

- **F29:** Universal EDID for DVI signals (no audio support).
- **F47:** HDMI EDID supporting PCM audio.
- **F48:** HDMI EDID supporting all type of audio.
- **F49:** HDMI EDID supporting all type of audio and deep color.
- **F89:** Universal EDID for analog signals (no audio support).
- **F118:** HDMI EDID supporting PCM audio and 4K@30 Hz signals.
- **F119:** HDMI EDID supporting all type of audio and 4K@30 Hz signals.

Please note that minor changes in the factory EDID list may be applied in further firmware versions.

## 12.6. Cable Wiring Guide

Inputs and outputs of audio devices are symmetric or asymmetric. The main advantage of the symmetric lines is the better protection against the noise, therefore they are widely used in the professional audio industry. Symmetric audio is most often referred to as balanced audio, as opposed to asymmetric, which is referred to as unbalanced audio. Lightware products are usually built with 5-pole Phoenix connectors, so we would like to help users assemble their own audio cables. See the most common cases below.

**ATTENTION!** Symmetric and asymmetric lines can be linked with passive accessories (e.g. special cables), but in this case half of the line level is lost.

**ATTENTION!** There are numerous types of regularly used connector and cable types to connect audio devices. Please always make sure that a connector or cable fits your system before use.

**ATTENTION!** Never join the phase-inverted (negative, cold or -) poles (either right or left) to the ground or to each other on the output side, as this can damage the unit.

**INFO:** Use a galvanic isolation in case of a ground loop.

### 12.6.1. Serial Ports

The device is built with a 3-pole Phoenix connector. See the examples below of connecting to a DCE (Data Circuit-terminating Equipment) or a DTE (Data Terminal Equipment) type device:

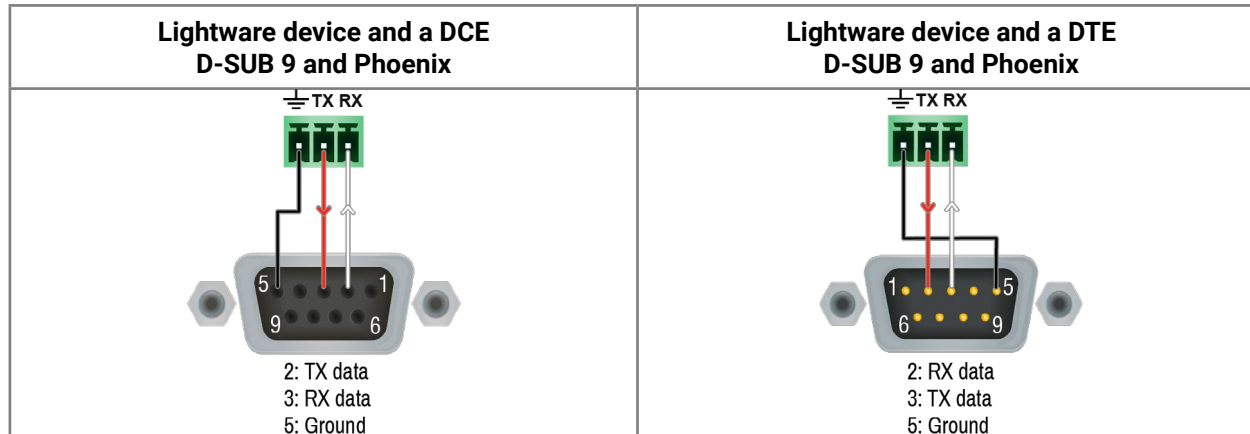

### 12.6.2. Audio Ports

#### The Pinout of the 5-pole Phoenix Connector



Pin nr.	Signal
1	Left+
2	Left-
3	Ground
4	Right-
5	Right+

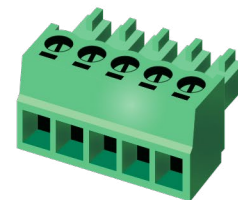

Compatible Plug Type: Phoenix® Combicon series (3.5mm pitch, 5-pole), type: MC 1.5/5-ST-3.5.

#### From Balanced Output to Unbalanced Input

##### Phoenix - 2 x 6.3 (1/4") TS

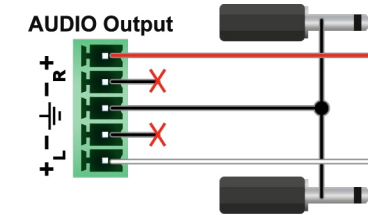

##### Phoenix - 2 x RCA

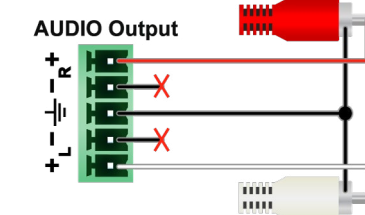

##### Phoenix - 3.5 (1/8") TRS

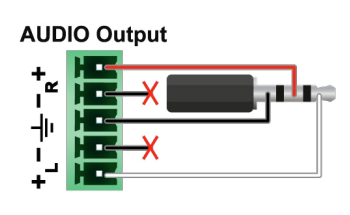

#### From Balanced Output to Balanced Input

##### Phoenix - 2 x 6.3 (1/4") TRS

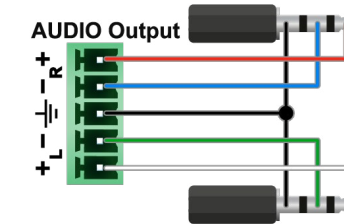

##### Phoenix - 2 x XLR

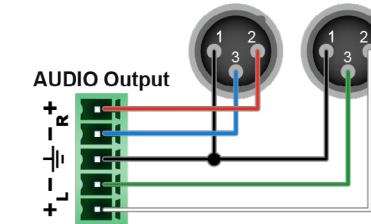

## 12.7. Factory Default Settings

Parameter	UCX-4x3-TPX-TX20	UCX-2x1-TPX-TX20	UCX-3x3-TPX-RX20	HDMI-UCX-TPX-RX107
<b>Video port settings</b>				
Connected source (O1/O2/O3)	I1/I2/I3	I1/I2	I1/I2/I3	I1/-/-
Allowed HDCP Version (I1/I2/I3/I4)	1.4/1.4/2.2/2.2	2.2/2.2	2.2/2.2/1.4	2.2/-/-/-
Hotplug detect mode (HPD) at input ports	auto			
Display Welcome Screen Image	true			
Display Welcome Screen Message	false			
Output 5V mode / signal type	on / auto			
Output HDCP mode	auto			
Video autoselect	disabled			
Emulated EDID	Factory #47: Universal HDMI PCM			
<b>Analog audio output port settings</b>				
Volume	0 dB, 100%			
Balance	0 (center)			
<b>Network settings</b>				
Factory default IP address mode	DHCP			
Static IP address	192.168.0.100			
Static network mask	255.255.255.0			
Static gateway address	192.168.0.1			
Hostname	lightware-<serialno>			
LW3 protocol	enabled			
HTTP, HTTPS	enabled			
HTTP, HTTPS authentication	disabled			
Authentication setting (user/password)	admin/<not set>			
<b>USB port settings</b>				
USB-C Power Limit	equal output power	100W	-	-
DP Alternate Mode Policy	4-Lane		-	-
Port Power Role	dual Role			
Autoselect	follow video O1			
D1-D4 Power 5V Mode	auto			

<b>RS-232 port settings</b>		
RS-232 port	9600 BAUD, 8, N, 1	115200 BAUD, 8, N, 1
RS-232 serial over IP	enabled	-
<b>GPIO port settings</b>		
Output level	low	-
Direction	input	-
<b>Miscellaneous</b>		
Control lock	disabled	
Dark mode	disabled	
Automatic fan control	enabled	
User EDID memory	empty	
LARA	disabled	

INFO: The -LCC models have the same values as non-LCC models.

## 12.8. Content of the Backup File

The backup file contains numerous settings and parameters saved from the device. When the file is uploaded to a device, the following will be overwritten:

<b>Audio / Video crosspoint settings</b>
Mute state, Lock state, Crosspoint state
Autoselection (mode, port priority)
<b>USB ports</b>
Port name, Port type, Lock state, Crosspoint state, Power +5V mode
Autoselection (mode, port priority)
Lane management status, DisplayPort Alternate Mode policy, Power role setting, Power limit
USB-C video parameters (HDCP mode, Output signal type, Embedded audio mute state, Power +5V mode)
<b>HDMI input ports</b>
Video port name, Audio port name, HDCP setting
<b>HDMI output ports</b>
Port name, HDCP mode, HDMI mode, Power +5V mode
<b>Analog audio port</b>
Port name, Volume, Balance
<b>Local serial port</b>
Port name, RS-232 mode, Control protocol, Baud rate, Data bits, Stop bits, Parity
<b>GPIO port</b>
Port name, Direction, Level
<b>OCS port</b>
Sensor type, Port name
<b>Network settings</b>
Port name, Port status. PHY (speed and duplexity) mode
HTTP/HTTPS port status, HTTP/HTTPS Authentication status
LW3 port status, Serial port status
LARA full configuration
<b>Further settings</b>
Control lock status, Device label, Dark mode state, Dark mode delay
User EDID data (U1-U100), Emulated EDIDs by ports
Welcome screen status, Welcome screen parameters
Power supply output power limit
NTP (Date and time settings)

## 12.9. Mechanical Drawings

### UCX-4x3-TPX-TX20, UCX-2x1-TPX-TX20

- INFO: UCX-4x3-TPX-TX20 and UCX-2x1-TPX-TX20 models have the same size. Dimensions are in mm.
- INFO: The -LCC models have the same values as non-LCC models.

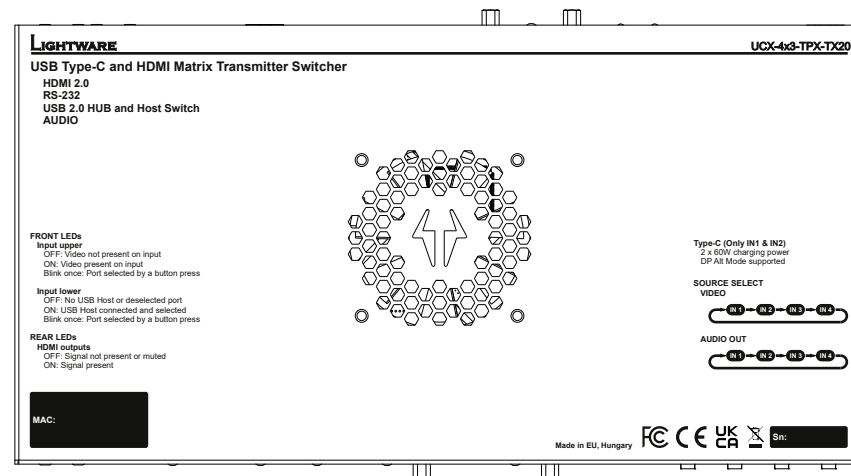
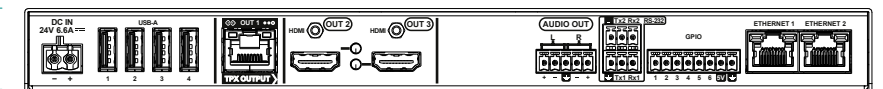
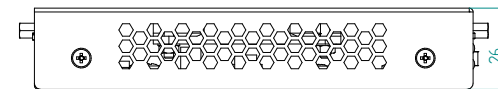
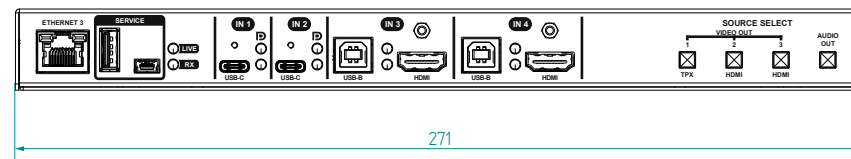
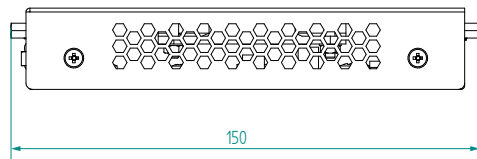
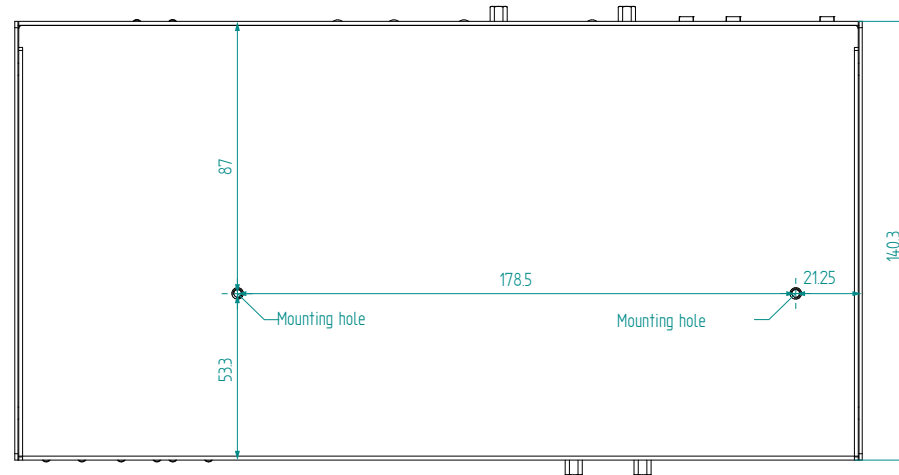

**UCX-3x3-TPX-RX20**

INFO: The -LCC models have the same values as non-LCC models.

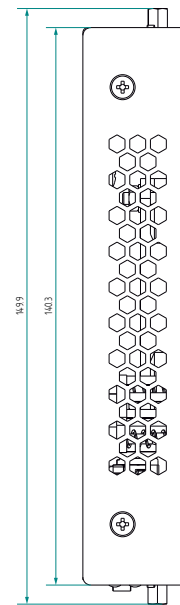
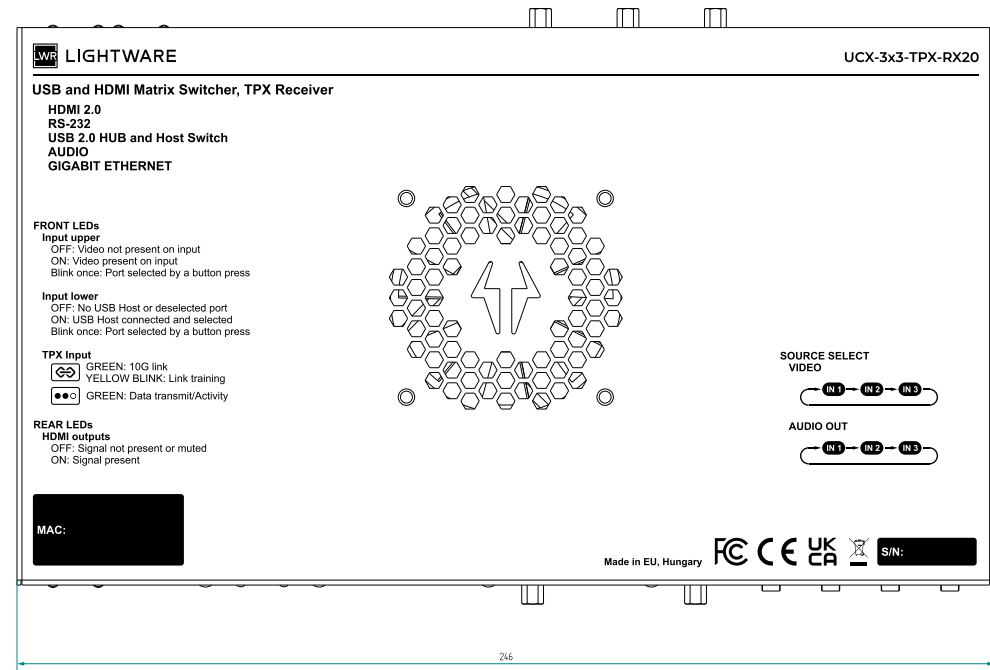
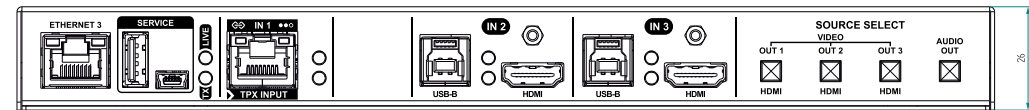
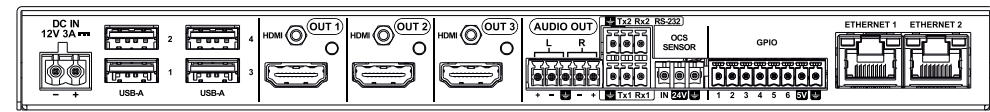

**HDMI-UCX-TPX-RX107**

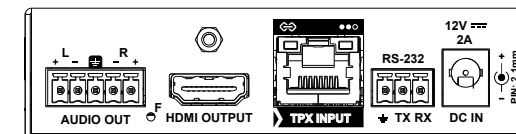
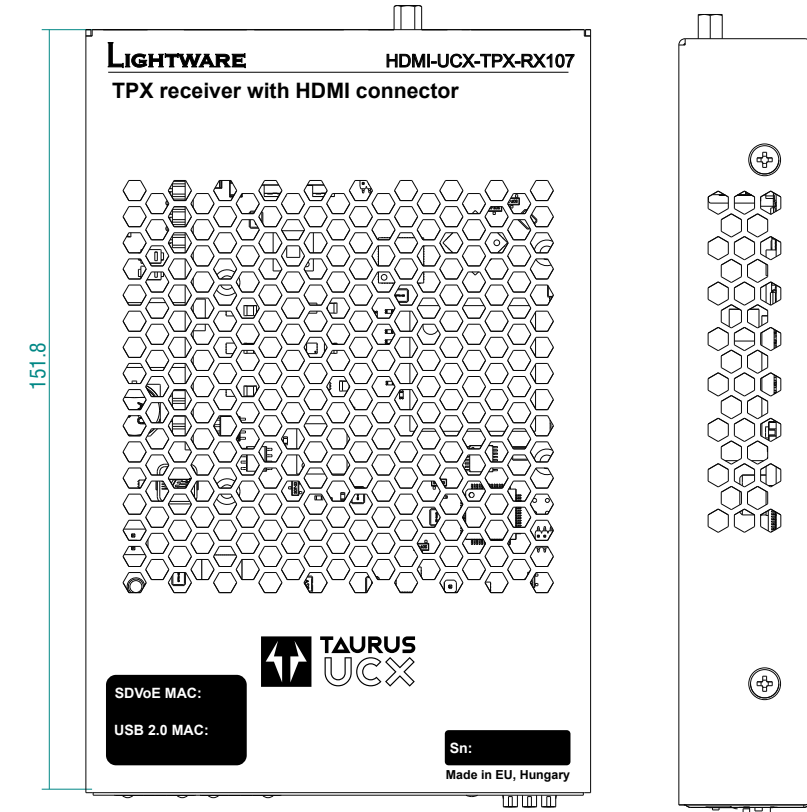
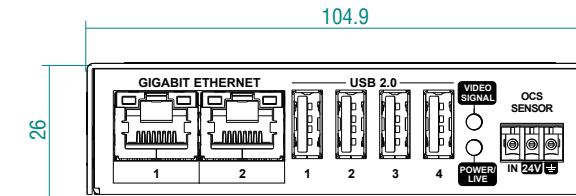

## 12.10. Firmware Release Notes for UCX-TX Devices

The list below shows the released firmware packages with important notes.

### v1.13.0b3

Release date: 2024-11-19

#### New feature:

- General Security Update: Aims to ensure compliance with security standards.
- Tx-RX Communication Robustness Improvement: HDMI-TPX and HDMI-TPN product families now require a minimum firmware version of 2.5.2.
- Network Separation: Introduces a network port on TX boxes that filters traffic, making only the main MAC address visible. When network separation is enabled, RX updates through LDU are not possible. Please refer to the user manual for further details. Network separation is not yet supported for UCX-TPN products. Additional setup limitations are also documented in the user manual.
- OpenSSH Update: Addressed security vulnerabilities by upgrading to OpenSSH v9.8.

#### Bugfix:

- LARA Redirect Bug: Fixed an issue in the Taurus Webserver where redirects caused confusion in the frontend due to unclear sources
- Logging Improvements: Fixed an issue preventing logs from being saved to permanent storage by updating the logging configuration to ensure proper functionality.
- LARA Name Resolution Bug: Resolved an issue where the LARA script encountered name resolution errors, causing unexpected termination.

### v1.11.1b4

Release date: 2024-09-24

#### New feature:

- Critical issues during first time programming have been fixed.

### v1.11.0b3

Release date: 2024-08-02

#### New feature:

- Fixed a known, critical issue which was impacting the TX-RX USB layers.

#### Known issue:

- USB-C Ethernet connection instabilities.

### v1.10.0b2

Release date: 2024-07-02

#### New feature:

- System setups where: Taurus UCX-2x1-TPX-TX20 OR Taurus UCX-4x3-TPX-TX20 connected with Taurus UCX-3x3-TPX-RX20 are officially supported now (both LEX and REX modes).
- LARA 1.2.0b41 integration ( Taurus UCX-3x3-TPX-RX20 driver is included now).

### v1.9.0b9

Release date: 2024-06-14

#### New feature:

- FlowControl handling on serial port is now supported.
- Power Management change. PoE "auto" mode option has been removed.
- Two lane DisplayPort alternate mode is now available as well in case the four lane alternate mode setting is not supported.
- New experimental LW3 node is available for testing now: EXPERIMENTAL/MEDIA/USB/Service. Enabled.
- USB access is available via service port for demonstrating and piloting the StreamDeck device support in LARA.
- Taurus TPX-TX20 and HDMI RX communication channel has been significantly improved. Further upgrades are coming.
- Password history is now maintained on web authentication. The past ten passwords are no longer available to used.
- UCX-4x3-TPN-TX20 is now officially supported.
- LARA 1.2.0b40 integration.
- A critical issue has been fixed at the USB-C Ethernet connection.
- Critical issues have been fixed at the launch of the LARA configurations.
- UCX-2x1-TPN-TX20 is now officially supported.

#### Known issue:

- USB-C Ethernet connection occasionally disconnects the connecting devices.

### v1.7.0b6

Release date: 2024-01-16

#### New feature:

- Disabled USB-C Ethernet ports are also disabling the ethernet bridge now.
- Complete redesign of the WebLDC's session management. A new logout button has been introduced for logging out from the session. After 120 minutes the session will be closed and the user is going to be logged out automatically. After 15 minutes of inactivity the session will be closed also. 2 minutes prior to the inactivity logout the user has to option to confirm the willingness to keep using the system.



- LARA 1.2 integration.
- Time zones are available option now for timed events. A new optional NTP service has been introduced. A new LW API has been introduced for date/time settings. The device does observe now both the UTC and both the local times.
- RX ethernet ports can be enabled / disabled now from the TPX-TX's WebLDC. A new LW API has been introduced for the ethernet port handling. The transparent VLAN mode will remain as a default.
- UCX-2x1-TPX-TX20 is supported now.
- Separated VLAN presents are available now. WebLDC supports now the selection of the different presets.

#### v1.4.0b8

Release date: 2023-11-09

##### New feature:

- Health Status improvement - AVX and 10G PHY temperatures are now available on the WebLDC.
- RX Audio DAC volume ( % and dB) is now configurable at WebLDC.

#### v1.3.0b4

Release date: 2023-09-28

##### New feature:

- Lara 1.1.10 integration
- UDP and TCP ports between 20.000 and 30.000 are free to use including from LARA scripts. The clear list of the open new ports are included in the LARA disclaimer.
- AVX firmware version upgrade from 1.5 into 2.0.
- Please update your TPX firmware version into 2.3.0b15 to avoid any behavior issues.

#### v1.2.0b3

Release date: 2023-09-07

##### New feature:

- The extended serial port is configurable now.
- RX Ethernet ports can be disabled/enabled now.
- Power modes of the RX USB-A ports are adjustable now (Auto/Off).
- Health statuses (AVX and 10G PHY temperatures) are available now.
- RX OCS is available and configurable now.

#### v1.1.0b4

Release date: 2023-08-15

##### New feature:

- 100W charging settings are available now on the user interface

- LARA v1.1.9 has been integrated. For more information please read the LARA release notes.

##### Bugfix:

- The following properties can be set to On or Off mode: /V1/MEDIA/VIDEO/O1.Output5VMode /V1/MEDIA/VIDEO/O2.Output5VMode Auto mode will be available in a future release.
- Ethernet port P5 is counting TX Ethernet packets even if there is no connection. /MEDIA/ETHERNET/P5/COUNTERS.TxCounter Ethernet packet transmission on P5 is not affected by this issue. This Ethernet port works as expected other than the incorrect TX counter value.
- If a USB Host without DisplayPort Alterante mode support is connected to one of the USB Type-C connectors, then the ActiveAltMode property erroneously reads as DP. /V1/MEDIA/USB/U1.ActiveAltMode=DP This issue causes Lightware Device Controller to erroneously display a yellow "DP" indicator on the port panel, which means the connection successfully entered DisplayPort Alterante mode. The following property describing the DisplayPort Alterante mode capability of the connected Host works as expected. /V1/MEDIA/USB/U1.HostSupportsDpAltMode=false USB and Displayport Data transmission is not affected.
- An external control system using LW3 protocol subscribed to an HDMI output node OPEN /V1/MEDIA/VIDEO/O1 might not receive all CHG messages related to the presence of embedded audio on the output. For example if the video crosspoint switches beteen two sources: one with- and one without embedded audio, then the following CHG messages might be missing: CHG /V1/MEDIA/VIDEO/O1.EmbeddedAudioPresent=false CHG /V1/MEDIA/VIDEO/O1.EmbeddedAudioPresent=true Transmission of the embedded audio stream from input to output is unaffected. Muting the audio also works as expected.

#### v1.0.0b5

Release date: 2023-07-27

##### New feature:

- First Release of Taurus TX with: - Video extension, - USB2.0 extension, - LARA v1.1.8 has been integrated into Taurus-UCX-TX v1.0.0. For more information please read LARA release notes. - TX Serial port 3 to RX has fixed Baudrate of 115200 Limitations, will be implemented in upcoming firmware releases: - No OCS - No connection information from RX to TX - Fully transparent 1G Ethernet ports, no separation - 100W charging is going to be only available on LW3 for as of now

## 12.11. Firmware Release Notes for UCX-TPX-RX Devices

The list below shows the released firmware packages with important notes.

### v1.3.0b2

Release date: 2024-11-19

#### New feature:

- OpenSSH Update: Addressed security vulnerabilities by upgrading to OpenSSH v9.8.
- General Security Update: Aims to ensure compliance with security standards.
- Network Separation: Introduces a network port on TX boxes that filters traffic, making only the main MAC address visible. When network separation is enabled, RX updates through LDU are not possible. Please refer to the user manual for further details. Network separation is not yet supported for UCX-TPN products. Additional setup limitations are also documented in the user manual.

#### Bugfix:

- Logging Improvements: Fixed an issue preventing logs from being saved to permanent storage by updating the logging configuration to ensure proper functionality.
- LARA Name Resolution Bug: Resolved an issue where the LARA script encountered name resolution errors, causing unexpected termination.
- LARA Redirect Bug: Fixed an issue in the Taurus Webserver where redirects caused confusion in the frontend due to unclear sources

### v1.1.0b2

Release date: 2024-08-02

#### New feature:

- Stability, security and UX improvements.
- Several LW3 nodes have been fixed and optimized.

### v1.0.0b2

Release date: 2024-06-28

#### New feature:

- First initial release of the new Taurus UCX-3x3-TPX-RX20.

## 12.12. Firmware Release Notes for HDMI-TPX-RX Devices

### v2.5.2b1

Release date: 2024-11-19

#### New feature:

- From this version on, the copper based scaling receivers (HDMI-TPX-RX107A-SR and HDMI-TPX-RX107AU2K-SR) are also supported.

#### Bugfix:

- Improved on the quality of the link between the TX and the RX devices. This has a positive effect both on the RS232 and the Ethernet communication.

#### Known issue:

- When a scaling receiver is connected to a transmitter in point-to-point mode, the image output may become unstable if, the receiver is in fast switch mode and the embedded audio is set to 192 kHz and 24-bit.
- RS232 settings on AVX are not reset properly on the TX device after a factory reset when more than one SDVoE Control Server is present on the network.
- Factory resetting the RX device causes the established USB KVM connection not to work anymore. Restarting either the transmitter or the receiver resolves the problem.

### v2.5.0b8

Release date: 2024-06-19

#### New feature:

- From this version on, the copper based scaling receivers (HDMI-TPX-RX107A-SR and HDMI-TPX-RX107AU2K-SR) are also supported.

#### Bugfix:

- Fixed a bug that caused a 422 10bit input signals to be converted to 422 8bit during transmission.
- Fixed a bug that caused the de-embedded audio to be muted on the analog audio output when a display with DVI EDID is connected to the local output of the transmitter device.
- From this version on, the HDCP is reported as not supported towards a source connected to a TX device when the supported HDCP version of the sink connected to the RX unit cannot be determined.
- Fixed a bug that caused the video signal on the HDMI output of a receiver device to disappear when the HDMI cable to a sink device is disconnected and connected again.

#### Known issue:

- Factory resetting either the TX or the RX device causes the established USB2.0 connection not to work anymore. Unplugging and replugging the corresponding USB device or restarting either the transmitter or the receiver resolves the problem.

**v2.4.0b8**

Release date: 2023-11-08

**New feature:**

- From this version on, the health status of the receiver can be queried and the analog audio volume can be set from a compatible transmitter device.

**Bugfix:**

- Fixed a bug that caused the USB2.0 output not to function after updating the HDMI-TPX-TX and HDMI-TPX-RX pair.
- Fixed a bug that caused a video with color depth of 10 or 12 bit/component to be converted to 8 bit/component.
- Fixed a bug that resulted in muted audio on the analog output after a factory reset (e.g., during firmware upgrade).
- Fixed a bug that caused the USB2.0 and Ethernet transmission to stop intermittently when switching between HDMI1.4 and HDMI2.0 video signals on the input of the transmitter.

**Known issue:**

- A clicking sound can be heard in the analog audio output of a receiver device when the format of the input HDMI stream changes.
- A clicking sound can be heard in the analog audio output when the audio content in the incoming HDMI stream changes from compressed audio to uncompressed audio or vice versa.

**v2.3.0b15**

Release date: 2023-09-28

**Known issue:**

- When switching between HDMI1.4 and HDMI2.0 video signals on the input of the transmitter, the USB2.0 and Ethernet transmission intermittently drops. USB HID is not affected.
- When updating the HDMI-TPX-TX and HDMI-TPX-RX pair, it might happen that the USB2.0 output stops functioning. Restarting the RX and the TX devices resolves the problem.
- When a display with DVI EDID is connected to the local output of the HDMI-TPX-TX transmitter, the de-embedded audio is muted on the analog audio output.
- 422 10bit signals are converted to 422 8bit during transmission.

**v2.2.0b5**

Release date: 2023-07-27

**New feature:**

- From this version on, the HDMI-UCX-TPX-RX107 product variant is also supported.

**Bugfix:**

- Fixed a bug that could have resulted in intermittent drop outs of the transmitted audio content on the output for a brief period of time.
- Fixed a bug that potentially could cause a crash on the receiver if the video reception was unstable.

**Known issue:**

- Video with a color depth of 10 or 12 bit/component is converted to 8 bit/component. Consequently, Dolby Vision and HDR is not supported.
- Factory resetting the device mutes the audio on the analog output. A power cycle restores audio de-embedding to the analog output.

## 12.13. Hashtag Keyword List

This user's manual contains keywords with hashtags (#) to help you find the relevant information as quick as possible.

The format of the keywords is the following:

#<keyword>

The usage of the keywords: use the **Search** function (Ctrl+F / Cmd+F) of your PDF reader application, type the # (hashtag) character and the wished keyword.

The **#new** special keyword indicates a new feature/function that has just appeared in the latest firmware or software version.

### Example

*#dhcp*

This keyword is placed at the DHCP (dynamic IP address) setting in the front panel operation, the Lightware Device Controller (LDC) and the LW3 programmer's reference section.

The following list contains all hashtag keywords placed in the document with a short description belonging to them. The list is in **alphabetical order** by the hashtag keywords.

Hashtag Keyword ↓	Description
<i>#advancedview</i>	Advanced view / Terminal window
<i>#alternatemode</i>	Displayport Alternate mode settings
<i>#analogaudio</i>	Analog audio related settings
<i>#authentication</i>	Authentication settings
<i>#autoselect</i>	Autoselect feature settings
<i>#balance</i>	Balance (for analog audio) setting
<i>#buttonlock</i>	Front panel button lock setting
<i>#cablediagnostics</i>	Cable diagnostics tool in LDC
<i>#cec</i>	CEC-related settings
<i>#crosspoint</i>	Crosspoint switch setting
<i>#devicelabel</i>	Device label
<i>#dhcp</i>	Dynamic IP address (DHCP) setting
<i>#diagnostic</i>	Failure diagnostic related tool/information
<i>#displayportalternatemode</i>	Displayport Alternate mode settings
<i>#dpaltmode</i>	Displayport Alternate mode settings
<i>#edid</i>	EDID related settings
<i>#factory</i>	Factory default settings
<i>#fips</i>	FIPS related information
<i>#firmwareversion</i>	Firmware version query

Hashtag Keyword ↓	Description
<i>#framedetector</i>	Frame detector in LDC
<i>#hdcp</i>	HDCP-encryption related setting
<i>#http</i>	Http-related settings
<i>#https</i>	Https-related settings
<i>#ipaddress</i>	IP address related settings
<i>#label</i>	Device label
<i>#lock</i>	Port lock setting
<i>#lockbutton</i>	Front panel button lock setting
<i>#log</i>	System log
<i>#mute</i>	Port mute setting
<i>#network</i>	Network (IP address) related settings
<i>#portstatus</i>	Source/destination port status query
<i>#power</i>	Power sending settings
<i>#producttype</i>	Product type query
<i>#reboot</i>	Restarting the device
<i>#restart</i>	Restarting the device
<i>#rs232</i>	RS-232 related settings
<i>#rs-232</i>	RS-232 related settings
<i>#security</i>	Network security settings
<i>#serial</i>	RS-232 related settings
<i>#serialnumber</i>	Serial number query
<i>#signaltype</i>	HDMI/DVI signal type setting
<i>#status</i>	Status query
<i>#switch</i>	Crosspoint switch setting
<i>#systemlog</i>	System log
<i>#terminal</i>	Advanced view / Terminal window
<i>#testpattern</i>	Test pattern (no sync screen) settings
<i>#unlock</i>	Port unlock setting
<i>#unmute</i>	Port unmute setting
<i>#usb</i>	USB 2.0 interface-related settings
<i>#usbc</i>	USB-C interface-related settings
<i>#volume</i>	Volume (for analog audio) setting
<i>#welcomescreen</i>	Welcome screen settings
<i>#password</i>	Password setting

## 12.14. Further Information

### Limited Warranty Statement

1. Lightware Visual Engineering PLC (Lightware) warrants to all trade and end user customers that any Lightware product purchased will be free from manufacturing defects in both material and workmanship for three (3) years from purchase unless stated otherwise below. The warranty period will begin on the latest possible date where proof of purchase/delivery can be provided by the customer. In the event that no proof can be provided (empty 'Date of purchase' field or a copy of invoice), the warranty period will begin from the point of delivery from Lightware.

1.1. 25G and MODEX product series will be subject to a seven (7) year warranty period under the same terms as outlined in this document.

1.2. If during the first three (3) months of purchase, the customer is unhappy with any aspect of a Lightware product, Lightware will accept a return for full credit.

1.3. Any product that fails in the first six (6) months of the warranty period will automatically be eligible for replacement and advanced replacement where available. Any replacements provided will be warranted for the remainder of the original unit's warranty period.

1.4. Product failures from six (6) months to the end of the warranty period will either be repaired or replaced at the discretion of Lightware. If Lightware chooses to replace the product, then the replacement will be warranted for the remainder of the original unit's warranty period.

2. The above-stated warranty and procedures will not apply to any product that has been:

2.1. Modified, repaired or altered by anyone other than a certified Lightware engineer unless expressly agreed beforehand.

2.2. Used in any application other than that for which it was intended.

2.3. Subjected to any mechanical or electrical abuse or accidental damage.

2.4. Any costs incurred for repair/replacement of goods that fall into the categories above (2.1., 2.2., 2.3.) will be borne by the customer at a pre-agreed figure.

3. All products to be returned to Lightware require a return material authorization number (RMA) prior to shipment, and this number must be clearly marked on the box. If an RMA number is not obtained or is not clearly marked on the box, Lightware will refuse the shipment.

3.1. The customer will be responsible for in-bound, and Lightware will be responsible for out-bound shipping costs.

3.2. Newly repaired or replaced products will be warranted to the end of the originally purchased product's warranty period.

### Document Revision History

Rev.	Release date	Changes	Editor
1.0	15-09-2023	Initial version	Nikolett Keindl
1.1	09-11-2023	Volume and balance setting options added for RX analog audio port, Release Notes chapter updated, minor corrections	Nikolett Keindl
1.2	25-01-2024	UCX-2x1-TPX-TX20 added, Built-in Web chapter added, other minor changes	Nikolett Keindl
1.3	10-04-2024	Password authentication updated, minor corrections	Nikolett Keindl
1.4	09-08-2024	UCX-3x3-TPX-RX20 variant added, FIPS 140-2 chapter added, Powering options chapter updated, Mounting Options chapter updated, minor corrections	Nikolett Keindl
1.5	26-11-2024	Advanced Ethernet chapter updated, minor corrections	Nikolett Keindl

### Contact Us

[sales@lightware.com](mailto:sales@lightware.com)

+36 1 255 3800

[support@lightware.com](mailto:support@lightware.com)

+36 1 255 3810

**Lightware Visual Engineering PLC.**

Peterdy 15, Budapest H-1071, Hungary

[www.lightware.com](http://www.lightware.com)

©2024 Lightware Visual Engineering. All rights reserved. All trademarks mentioned are the property of their respective owners. Specifications subject to change without notice.