



LIGHTWARE
INNOVATIVE. RELIABLE. MADE IN EUROPE.

User's Manual



UCX-2x1-HC30, UCX-2x2-H30
UCX-4x2-HC30, UCX-4x2-HC30D
UCX-4x2-HC40D, (-LCC)
UCX-4x3-HC40, (-LCC)

UCX-2x1-HC40, (-LCC), UCX-2x2-H40, (-LCC)
UCX-4x2-HC40, (-LCC)
UCX-4x3-HC40-BD, (-LCC)
DCX-2x1-HC10, DCX-3x1-HC20

Universal Switcher

Important Safety Instructions

Class II apparatus construction.

The equipment should be operated only from the power source indicated on the product.

To disconnect the equipment safely from power, remove the power cord from the rear of the equipment or from the power source. The MAINS plug is used as the disconnect device, the disconnect device shall remain readily operable.

There are no user-serviceable parts inside of the unit. Removal of the cover will expose dangerous voltages. To avoid personal injury, do not remove the cover. Do not operate the unit without the cover installed.

The appliance must be safely connected to multimedia systems. Follow instructions described in this manual.

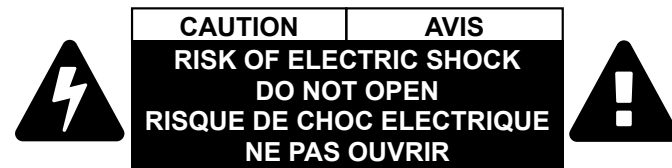

Ventilation

For the correct ventilation and to avoid overheating, ensure enough free space around the appliance. Do not cover the appliance, leave the ventilation holes free and never block or bypass the ventilators (if there are any).

WARNING

To prevent injury, the apparatus is recommended to be securely attached to the floor/wall, or mounted in accordance with the installation instructions. The apparatus shall not be exposed to dripping or splashing, and no objects filled with liquids, such as vases, shall be placed on the apparatus. No naked flame sources, such as lit candles, should be placed on the apparatus.

Waste Electrical & Electronic Equipment WEEE

This marking shown on the product or its literature indicates that it should not be disposed with other household wastes at the end of its working life. To prevent possible harm to the environment or human health from uncontrolled waste disposal, please separate this from other types of wastes and recycle it responsibly to promote the sustainable reuse of material resources. Household users should contact either the retailer where they purchased this product or their local government office for details of where and how they can take this item for environmentally safe recycling. Business users should contact their supplier and check the terms and conditions of the purchase contract. This product should not be mixed with other commercial wastes for disposal.

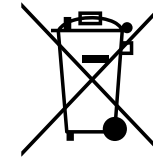

CAUTION

The device contains a BR1632A button battery, which supplies power to the clock when the device is not powered on. Danger of explosion if battery is replaced incorrectly. Replace only with the same or equivalent type.

WARNING

Do not ingest the battery, Chemical Burn Hazard. This product contains a coin/button cell battery. If the coin/button cell battery is swallowed, it can cause severe internal burns in just 2 hours, and can lead to death. Keep new and used batteries away from children. If the battery compartment does not close securely, stop using the product and keep it away from children. If you think batteries might have been swallowed or placed inside any part of the body, seek immediate medical attention.

Common Safety Symbols

Symbol	Description
	Direct current
	Alternating current
	Double insulation
	Caution, possibility of electric shock
	Caution

Symbol Legend

The following symbols and markings are used in the document:

WARNING! Safety-related information that is highly recommended to read and keep in every case!

ATTENTION! Useful information for performing a successful procedure; it is recommended to read.

DIFFERENCE: Feature or function that is available with a specific firmware/hardware version or product variant.

INFO: A notice, which may contain additional information. Procedure can be successful without reading it.

DEFINITION: The short description of a feature or a function.

TIPS AND TRICKS: Ideas that you may have not known yet, but can be useful.

Navigation Buttons

 Go back to the previous page. If you clicked on a link previously, you can go back to the source page by pressing the button.

 Navigate to the Table of Contents.

 Step back one page.

 Step forward to the next page.

Document Information

All presented functions refer to the indicated products. The descriptions have been made while testing these functions in accordance with the indicated Hardware/Firmware/Software environment:

Item	Version
Lightware Device Controller (LDC) software	2.11.0b3
Lightware Device Updater V2 (LDU2) software	2.30.0b2
Firmware package (HC40 models)	2.14.0b3
Firmware package (HC30 models)	2.11.0b3
Hardware	5.1

Document revision: **v1.26**

Release date: 09-08-2024

Editor: Nikolett Keindl

About Printing

Lightware Visual Engineering supports green technologies and eco-friendly mentality. Thus, this document is primarily made for digital use. If you need to print out a few pages for any reason, follow the recommended printing settings:

- Page size: A4
- Output size: Fit to page or Match page size
- Orientation: Landscape

TIPS AND TRICKS: Thanks to the size of the original page, a border around the content (gray on the second picture below) makes it possible to organize the pages better. After punching holes in the printed pages, they can easily be placed into a ring folder.

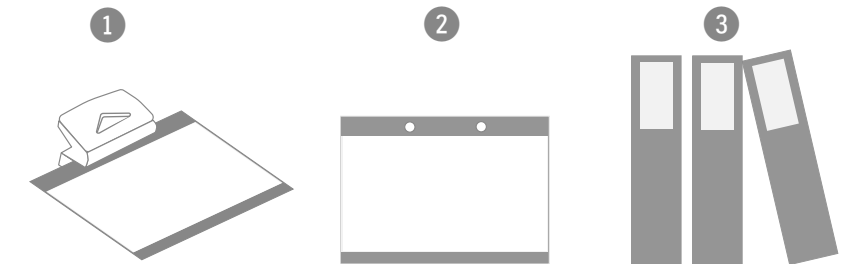

Hashtag (#) Keywords in the Document

This user's manual contains keywords with hashtags (#) to help you find the relevant information as quick as possible.

The format of the keywords is the following:

#<keyword>

The usage of the keywords: use the **Search** function (Ctrl+F / Cmd+F) of your PDF reader application, type the # (hashtag) character and the wished keyword.

The #new special keyword indicates a new feature/function that has just appeared in the latest firmware or software version.

Example

#dhcp

This keyword is placed at the DHCP setting command in the LW3 Programmer's reference section.

Table of Contents

1. INTRODUCTION	8	4.4.1. Power Data Objects (USB-C).....	33	5.14.1. Serial Port Diagram	59
1.1. DESCRIPTION	9	4.5. USB-C CABLE RECOMMENDATION	34	5.15. GPIO INTERFACE	60
1.2. BOX CONTENTS	10	4.6. CONNECTING STEPS	34	5.16. OCS INTERFACE	60
1.3. FEATURES OF THE DEVICE.....	11	5. DEVICE CONCEPT	35	5.17. FURTHER BUILT-IN FEATURES	61
1.4. MODEL COMPARISON	12	5.1. UNIVERSAL SWITCHER CONCEPT	36	5.17.1. Device Cloning – Configuration Backup and Restore.....	61
1.5. TYPICAL APPLICATION	13	5.2. USB INTERFACE	36	6. SOFTWARE CONTROL OPTIONS	62
2. PRODUCT OVERVIEW	14	5.2.1. USB-C Interface	36	6.1. SOFTWARE CONTROL MODES	63
2.1. FRONT VIEW - H(C)30 MODELS.....	15	5.2.2. USB Data - USB 3.1 Gen1 Interface	37	6.2. USING THE BUILT-IN WEB	64
2.2. FRONT VIEW - H(C)40 MODELS.....	16	5.2.3. USB Service Ports - USB 2.0 Interface	39	6.3. INSTALL AND UPDATE THE LDC	65
2.3. FRONT VIEW - DCX MODELS	17	5.3. VIDEO INTERFACE	39	6.4. RUNNING THE LDC	65
2.4. REAR VIEW - H(C)30 MODELS.....	18	5.3.1. Welcome Screen.....	40	6.5. ESTABLISHING THE CONNECTION	66
2.5. REAR VIEW - H(C)40 MODELS.....	19	5.3.2. Video Port Diagrams	40	6.6. BULK DEVICE MANAGEMENT	67
2.6. REAR VIEW - DCX MODELS	20	5.3.3. DisplayPort Alternate Mode.....	42	6.6.1. Network Settings	67
3. FRONT PANEL CONTROL	21	5.3.4. DisplayPort Alternate Mode and USB 3.x Mixed	42	6.6.2. Device Configuration.....	68
3.1. BUTTON FUNCTIONALITY	22	5.4. THE AUTOSELECT FEATURE	43	6.7. LDC LAYOUT	69
3.1.1. Video Source Selection	22	5.5. AUDIO INTERFACE	46	6.8. VIDEO & AUDIO CROSSPOINT	70
3.1.2. Enabling DHCP IP Address	23	5.5.1. Analog Audio Interface	46	6.8.1. Port Tiles.....	71
3.1.3. Reset to Factory Default Settings.....	23	5.5.2. Dante® Audio Interface.....	46	6.9. PORT PROPERTIES WINDOW	71
3.1.4. Control Lock.....	23	5.5.3. Dante® Audio Input.....	48	6.9.1. Welcome Screen.....	71
3.2. STATUS LEDs	24	5.6. ETHERNET INTERFACE	50	6.9.2. USB-C Inputs	72
3.2.1. Front Panel LEDs	24	5.7. LIGHTWARE ADVANCED ROOM AUTOMATION (LARA)	51	6.9.3. HDMI Video Input	74
3.2.2. Rear Panel LEDs	24	5.7.1. Opening the LARA interface	51	6.9.4. HDMI Video Output	75
3.2.3. Ethernet Status LEDs	24	5.7.2. Running LARA.....	51	6.9.5. Embedded Audio Input.....	76
3.2.4. Dante® Audio Port (UCX-4x2-HC30D, UCX-4x2-HC40D models) ..	25	5.7.3. Downloading/Uploading a Configuration	52	6.9.6. Analog Audio Output	77
3.2.5. Dante® Audio Port (UCX-4x3-HC40-BD model).....	25	5.7.4. Status Board	52	6.9.7. Frame Detector.....	77
4. INSTALLATION	26	5.7.5. Touch Panel Support.....	52	6.10. CEC TOOL	78
4.1. MOUNTING OPTIONS	27	5.8. BASIC NETWORK SECURITY	53	6.11. USB CROSSPOINT	79
4.1.1. 1U High Rack Shelf.....	27	5.8.1. Disable Ethernet Ports	53	6.11.1. USB-C Port Properties.....	79
4.1.2. Mounting Plate F100 (and PSU F100/F110)	27	5.8.2. HTTP/HTTPS.....	53	6.11.2. USB-B Port Properties.....	80
4.1.3. UD Mounting Pro P210 (and P120/P130).....	28	5.8.3. Encryption (HTTPS, WSS).....	54	6.12. EDID MENU	82
4.1.4. C-Lock	29	5.9. 802.1X AUTHENTICATION	55	6.12.1. EDID Operations	82
4.2. ELECTRICAL CONNECTIONS	30	5.10. ADVANCED ETHERNET SECURITY	56	6.12.2. EDID Summary Window	83
4.2.1. HDMI Input and Output Ports	30	5.10.1. Transparent.....	56	6.12.3. Editing an EDID	83
4.2.2. USB Connectors	30	5.10.2. Separated BYOD	56	6.12.4. Creating an EDID - Easy EDID Creator	84
4.2.3. Analog Stereo Audio	30	5.10.3. Dedicated.....	56	6.13. CONTROL MENU	84
4.2.4. Secure Control LAN, Utility AV LAN, Configurable Ethernet Port ..	30	5.10.4. Custom.....	57	6.13.1. Ethernet.....	84
4.2.5. OCS Connector	31	5.11. LIGHTWARE CRYPTO CORE	57	6.13.2. GPIO	85
4.2.6. GPIO - General Purpose Input/Output Ports.....	31	5.12. WEBSOCKET SERVICE (WS, WSS)	58	6.13.3. OCS - Occupancy Sensor	85
4.2.7. RS-232 Connector	32	5.13. BULK DEVICE MANAGEMENT	58	6.13.4. RS-232.....	86
4.3. POWERING OPTIONS	32	5.13.1. Network Settings.....	58	6.14. SETTINGS MENU	87
4.4. POWER DELIVERY OVER TYPE-C	33	5.13.2. Device Configuration.....	58	6.14.1. Status.....	87
		5.14. SERIAL INTERFACE	59	6.14.2. Network.....	88

6.14.3. Services.....	89	7.6.12. HDCP Setting (Input Port).....	104	7.12. USB PORT SETTINGS - USB-C RELATED COMMANDS	115
6.14.4. Power	91	7.6.13. HdcpMode	104	7.12.1. Setting the USB-C Power	115
6.14.5. System	92	7.6.14. Querying the Embedded Audio Presence	105	7.12.2. Setting the Displayport Alternate Mode Policy.....	115
6.15. ADVANCED VIEW WINDOW	93	7.6.15. Muting the Embedded Audio	105	7.12.3. Querying the Host Alternate Mode Support	116
7. LIGHTWARE REST API REFERENCE	94	7.6.16. Setting the Output Signal Type	105	7.12.4. Querying the Status of the Alternate Mode	116
7.1. OVERVIEW.....	95	7.6.17. Turning on Output 5V	105	7.12.5. Querying the Port Data Role	116
7.2. INSTRUCTIONS FOR THE TERMINAL APPLICATION USAGE.....	95	7.7. WELCOME SCREEN SETTINGS.....	106	7.12.6. Querying the Port Power Role	116
7.2.1. Web Browser Plugins	95	7.7.1. Displaying the Welcome Screen Image	106	7.12.7. Setting the Port Power Role.....	117
7.2.2. Terminal Application	96	7.7.2. Displaying the Welcome Screen Text.....	106	7.13. EDID MANAGEMENT	117
7.3. PROTOCOL RULES.....	97	7.7.3. Setting the Welcome Screen Text	106	7.13.1. Querying the Emulated EDIDs.....	117
7.3.1. Command Structure Example	97	7.7.4. Resetting the Welcome Screen Image.....	106	7.13.2. Querying the Validity of a Dynamic EDID	117
7.3.2. General Rules.....	97	7.8. VIDEO PORT SETTINGS - USB-C RELATED COMMANDS.....	106	7.13.3. Querying the Preferred Resolution of a User EDID.....	117
7.3.3. Legend for the Control Commands.....	98	7.8.1. Restarting the Link Training.....	106	7.13.4. Emulating an EDID to an Input Port.....	118
7.3.4. Lightware REST API vs. LW3 Protocol	98	7.9. CEC COMMAND SENDING	107	7.13.5. Emulating an EDID to All Input Ports	118
7.3.5. Method Types	98	7.9.1. Simple CEC Code Sending	107	7.13.6. Copying an EDID to User Memory	118
7.3.6. Supported Commands.....	98	7.9.2. Remote Control Code Sending	107	7.13.7. Deleting an EDID from User Memory	118
7.3.7. Not Supported Commands.....	99	7.10. AUDIO PORT SETTINGS.....	108	7.13.8. Resetting the Emulated EDIDs.....	119
7.3.8. Status Codes, Error Messages	99	7.10.1. Switching the Audio Input.....	108	7.14. ETHERNET PORT CONFIGURATION	119
7.3.9. Polling	99	7.10.2. Querying the Connected Source.....	108	7.14.1. Setting the DHCP State.....	119
7.4. REST API SECURITY.....	99	7.10.3. Querying the Connected Destinations	108	7.14.2. Changing the IP Address (Static)	119
7.4.1. Authentication	99	7.10.4. Setting the Autoselect Operation Mode.....	109	7.14.3. Changing the Subnet Mask (Static)	120
7.4.2. Encryption (HTTPS).....	99	7.10.5. Setting the Followed Video Port to Autoselect	109	7.14.4. Changing the Gateway Address (Static).....	120
7.5. SYSTEM COMMANDS.....	100	7.10.6. Enabling/Disabling the Dante USB Sound Card	109	7.14.5. Applying the Network Settings	120
7.5.1. Setting the Device Label	100	7.10.7. Setting the Audio Device Type for the Dante Input	109	7.14.6. Setting the Hostname	120
7.5.2. Resetting the Device.....	100	7.10.8. Locking the Audio Port	110	7.15. NETWORK SECURITY	121
7.5.3. Restoring the Factory Default Settings	100	7.10.9. Muting the Audio Port 1.....	110	7.15.1. Enabling/Disabling the Ethernet Port.....	121
7.5.4. Querying the Firmware Package Version.....	100	7.10.10. Muting the Audio Port 2.....	111	7.15.2. Querying the Network Service Port Number.....	121
7.5.5. Control Lock.....	100	7.10.11. Querying the Audio Signal Presence.....	111	7.15.3. Enabling/Disabling the Network Service Port	121
7.5.6. Setting the Current Time.....	101	7.10.12. Analog Audio Output Volume (dB) Setting	111	7.15.4. Querying the Username for Authentication	121
7.5.7. Identifying the Device.....	101	7.10.13. Analog Audio Output Volume Percent Setting	111	7.15.5. Setting a Password for Authentication.....	122
7.5.8. Toggling the Dark Mode Setting	101	7.10.14. Setting the Balance	112	7.15.6. Enabling the Authentication	122
7.5.9. Setting the Delay of the Dark Mode.....	101	7.10.15. Analog Audio Output Level Setting by Steps (dB).....	112	7.16. ADVANCED ETHERNET SECURITY	123
7.6. VIDEO PORT SETTINGS - GENERAL.....	102	7.10.16. Analog Audio Output Level Setting by Steps in Percent.....	112	7.16.1. Setting the VLAN Preset	123
7.6.1. Switching the Video Input.....	102	7.10.17. Analog Audio Output Balance Setting by Steps	112	7.16.2. Setting the VLAN Membership.....	123
7.6.2. Switching an Input to All Outputs	102	7.11. USB PORT SETTINGS	113	7.17. SERIAL PORT CONFIGURATION	124
7.6.3. Locking the Video Port.....	102	7.11.1. Switching the USB Input	113	7.17.1. BAUD Rate Setting.....	124
7.6.4. Muting the Video Port	102	7.11.2. Querying the Connected Source.....	113	7.17.2. Stop Bits Setting.....	124
7.6.5. Setting the Autoselect Policy.....	103	7.11.3. Querying the Connected Destinations	113	7.17.3. Querying the Data Bits	124
7.6.6. Changing the Autoselect-Included Input Ports.....	103	7.11.4. Locking the USB Port	113	7.17.4. Parity Setting	124
7.6.7. Changing the Input Port Priority	103	7.11.5. Setting the 5V Sending to the USB Peripherals	114	7.17.5. Querying the Serial over IP Port Number	125
7.6.8. Querying the Connected Source.....	103	7.11.6. Setting the USB Autoselect Policy	114	7.17.6. Enabling the Serial over IP Port.....	125
7.6.9. Querying the Connected Destinations	103	7.11.7. Setting the Followed Video Port to Autoselect	114	7.18. SERIAL PORT MESSAGING	125
7.6.10. Querying the Input Switching Capability	104	7.11.8. Changing the Autoselect Included USB Ports	114	7.18.1. Sending a Message via RS-232	125
7.6.11. Query the Video Signal Presence	104	7.11.9. Changing the USB Port Priority	115	7.19. GPIO PORT CONFIGURATION	126

7.19.1. Setting the Direction of a GPIO Pin	126	8.6.2. Switching an Input to All Outputs	142	8.10.16. Analog Audio Output Level Setting by Steps in Percent	153
7.19.2. Setting the Output Level of a GPIO Pin	126	8.6.3. Locking the Video Port	143	8.10.17. Analog Audio Output Balance Setting by Steps	153
7.19.3. Setting the Output Level for a Specified Time	126	8.6.4. Muting the Video Port	143	8.11. USB PORT SETTINGS	154
7.19.4. Toggling the Level of a GPIO Pin	126	8.6.5. Setting the Autoselect Policy	143	8.11.1. Switching the USB Input	154
7.20. OCS PORT CONFIGURATION	127	8.6.6. Changing the Autoselect Included Input Ports	143	8.11.2. Querying the Connected Source	154
7.20.1. Querying the Input Level of an OCS Pin	127	8.6.7. Changing the Input Port Priority	144	8.11.3. Querying the Connected Destinations	154
7.20.2. Setting the Sensor Type	127	8.6.8. Querying the Connected Source	144	8.11.4. Locking the USB Port	154
7.20.3. Querying the Reported OCS State	127	8.6.9. Querying the Input Switching Capability	144	8.11.5. Setting the 5V Sending to the USB Peripherals	155
7.21. UPDATING THE DEVICE VIA REST API	128	8.6.10. Querying the Connected Destinations	144	8.11.6. Setting the USB Autoselect Policy	155
7.21.1. Querying the Update REST API Version	128	8.6.11. Querying the Video Signal Presence	144	8.11.7. Setting the Followed Video Port to Autoselect	155
7.21.2. The Updating Process	128	8.6.12. HDCP Setting (Input Port)	144	8.11.8. Changing the Autoselect Included USB Ports	155
7.21.3. Uploading the Package	129	8.6.13. HdcpMode	145	8.11.9. Changing the USB Port Priority	155
7.21.4. Configuration Parameters – Keep the Current Settings	129	8.6.14. OutputSignalType	145	8.12. USB PORT SETTINGS - USB-C RELATED COMMANDS	156
7.21.5. Executing the Update	130	8.6.15. EmbeddedAudioPresent	145	8.12.1. Setting the USB-C Power	156
7.21.6. Querying the State of the Updating Process	130	8.6.16. EmbeddedAudioMute	145	8.12.2. Setting the Displayport Alternate Mode Policy	156
7.22. LIGHTWARE REST API QUICK SUMMARY	131	8.6.17. Output5VMode	145	8.12.3. Querying the Host Alternate Mode Support	156
8. LW3 PROGRAMMERS' REFERENCE	136	8.6.18. HDCP Capability (Output Port)	146	8.12.4. Querying the Status of the Alternate Mode	156
8.1. OVERVIEW	137	8.6.19. HDCP Setting (Output Port)	146	8.12.5. Querying the Port Data Role	157
8.2. INSTRUCTIONS FOR THE TERMINAL APPLICATION USAGE	137	8.7. WELCOME SCREEN SETTINGS	146	8.12.6. Querying the Port Power Role	157
8.3. WEBSOCKET (WS) OR SECURED WEBSOCKET (WSS) USAGE	137	8.7.1. Displaying the Welcome Screen Image	146	8.12.7. Setting the Port Power Role	157
8.4. PROTOCOL RULES	138	8.7.2. Displaying the Welcome Screen Text	146	8.13. EDID MANAGEMENT	158
8.4.1. LW3 Tree Structure and Command Structure (examples)	138	8.7.3. Setting the Welcome Screen Text	147	8.13.1. Querying the Emulated EDIDs	158
8.4.2. General Rules	138	8.7.4. Resetting the Welcome Screen Image	147	8.13.2. Querying the Validity of a Dynamic EDID	158
8.4.3. Legend for the Control Commands	138	8.8. VIDEO PORT SETTINGS - USB-C RELATED COMMANDS	147	8.13.3. Querying the Preferred Resolution of a User EDID	158
8.4.4. Command Types	139	8.8.1. Restarting the Link Training	147	8.13.4. Emulating an EDID to an Input Port	158
8.4.5. Prefix Summary	139	8.9. CEC COMMAND SENDING	148	8.13.5. Emulating an EDID to All Input Ports	158
8.4.6. Error Messages	139	8.9.1. Simple CEC Code Sending	148	8.13.6. Copying an EDID to User Memory	159
8.4.7. Escaping	139	8.9.2. Remote Control Code Sending	148	8.13.7. Deleting an EDID from User Memory	159
8.4.8. Signature	140	8.10. AUDIO PORT SETTINGS	150	8.13.8. Resetting the Emulated EDIDs	159
8.4.9. Subscription	140	8.10.1. Switching the Audio Input	150	8.14. ETHERNET PORT CONFIGURATION	160
8.4.10. Notifications about the Changes of the Properties	140	8.10.2. Querying the Connected Source	150	8.14.1. Setting the DHCP State	160
8.5. SYSTEM COMMANDS	141	8.10.3. Querying the Connected Destinations	150	8.14.2. Changing the IP Address (Static)	160
8.5.1. Setting the Device Label	141	8.10.4. Setting the Autoselect Operation Mode	150	8.14.3. Changing the Subnet Mask (Static)	160
8.5.2. Resetting the Device	141	8.10.5. Setting the Followed Video Port to Autoselect	150	8.14.4. Changing the Gateway Address (Static)	160
8.5.3. Restoring the Factory Default Settings	141	8.10.6. Enabling/Disabling the Dante USB Sound Card	151	8.14.5. Applying the Network Settings	160
8.5.4. Querying the Firmware Package Version	141	8.10.7. Setting the Audio Device Type for the Dante Input	151	8.14.6. Setting the Host Name	161
8.5.5. Control Lock	141	8.10.8. Locking the Audio Port	151	8.15. NETWORK SECURITY	161
8.5.6. Setting the Current Time	141	8.10.9. Muting the Audio Port 1	152	8.15.1. Enabling/Disabling the Ethernet Port	161
8.5.7. Identifying the Device	142	8.10.10. Muting the Audio Port 2	152	8.15.2. Querying the Service Port Number	161
8.5.8. Toggling the Dark Mode Setting	142	8.10.11. Querying the Audio Signal Presence	152	8.15.3. Enabling/Disabling the Service Port	161
8.5.9. Setting the Delay of the Dark Mode Setting	142	8.10.12. Analog Audio Output Volume (dB) Setting	152	8.15.4. Querying the Username for Authentication	162
8.6. VIDEO PORT SETTINGS - GENERAL	142	8.10.13. Analog Audio Output Volume Percent Setting	152	8.15.5. Setting a Password for Authentication	162
8.6.1. Switching Video Input	142	8.10.14. Setting the Balance	153	8.15.6. Enabling the Authentication	162

8.15.7. Restarting the Network Services.....	162	10. TROUBLESHOOTING	181
8.16. ADVANCED ETHERNET SECURITY	163	10.1. USE CASE STUDIES	182
8.16.1. Setting the VLAN Preset	163	10.2. HOW TO SPEED UP THE TROUBLESHOOTING PROCESS?	183
8.16.2. Setting the VLAN Membership.....	163	11. TECHNOLOGIES	184
8.17. SERIAL PORT CONFIGURATION	163	11.1. EDID MANAGEMENT	185
8.17.1. BAUD Rate Setting.....	163	11.1.1. Understanding the EDID.....	185
8.17.2. Stop Bits Setting.....	163	11.1.2. Advanced EDID Management.....	185
8.17.3. Querying the Data Bits	164	11.2. HDCP MANAGEMENT.....	186
8.17.4. Parity Setting	164	11.2.1. Protected and Unprotected Content	186
8.18. SENDING A MESSAGE VIA RS-232	164	11.2.2. Disable Unnecessary Encryption.....	186
8.19. GPIO PORT CONFIGURATION	164	11.2.3. HDCP 2.2.....	187
8.19.1. Querying the Direction of a GPIO Pin	164	11.3. PIXEL ACCURATE RECLOCKING	188
8.19.2. Setting the Direction of a GPIO Pin	164	12. APPENDIX	189
8.19.3. Querying the Output Level of a GPIO Pin	164	12.1. SPECIFICATIONS	190
8.19.4. Setting the Output Level of a GPIO Pin	165	12.2. PORT NUMBERING	193
8.19.5. Setting the Output Level for a Specified Time.....	165	12.3. APPLIED PORTS (NETWORK SETTINGS)	194
8.19.6. Toggling the Level of a GPIO Pin.....	165	12.4. FACTORY EDID LIST	195
8.20. OCS PORT CONFIGURATION.....	165	12.5. CABLE WIRING GUIDE.....	197
8.20.1. Querying the Input Level of an OCS Pin	165	12.5.1. Serial Ports	197
8.20.2. Setting the Sensor Type.....	165	12.5.2. Audio Ports	197
8.20.3. Querying the Reported OCS State	166	12.5.3. OCS Sensor.....	197
8.21. LW3 COMMANDS - QUICK SUMMARY	167	12.6. MECHANICAL DRAWINGS	198
9. FIRMWARE UPDATE.....	171	12.7. CONTENT OF THE BACKUP FILE	200
9.1. INTRODUCTION	172	12.8. FIRMWARE COMPATIBILITY TABLE.....	201
9.2. PREPARATION	172	12.9. FACTORY DEFAULT SETTINGS.....	202
9.2.1. About the Firmware Package (LFP2 File)	172	12.10. FIRMWARE RELEASE NOTES	203
9.2.2. LDU2 Installation	172	12.11. HASHTAG KEYWORD LIST	209
9.3. RUNNING THE SOFTWARE	173	12.12. FURTHER INFORMATION.....	210
9.4. UPDATING VIA GUI	174		
9.5. COMMAND LINE INTERFACE (CLI).....	176		
9.5.1. How to Run	176		
9.5.2. How to Use.....	176		
9.6. CLI COMMANDS	176		
9.6.1. Help	176		
9.6.2. LDU2 Version	177		
9.6.3. Check For New LDU2 Version.....	177		
9.6.4. Device Info	178		
9.6.5. Update.....	178		
9.6.6. Package Options	179		
9.6.7. Complex Example.....	179		
9.6.8. Exit Codes	179		
9.7. UPDATING VIA REST API.....	180		
9.8. IF THE UPDATE IS NOT SUCCESSFUL.....	180		

1

Introduction

Thank you for choosing Lightware's Taurus UCX-series devices. In the first chapter we would like to introduce the device, highlighting the most important features in the sections listed below:

- ▶ [DESCRIPTION](#)
- ▶ [BOX CONTENTS](#)
- ▶ [FEATURES OF THE DEVICE](#)
- ▶ [MODEL COMPARISON](#)
- ▶ [TYPICAL APPLICATION](#)

1.1. Description

Lightware’s universal switcher enhances and extends the possibilities of a meeting room and allows meeting participants to easily use their own devices such as laptops and preferred video conference platforms, while also utilizing the available assets of the meeting space, for example HDMI displays, room cameras and other USB peripherals.

The device utilizes the USB-C connectivity for a simplified transmission of 4K video, audio, control signals and power, and allows data speeds of up to 5 Gbps under the USB 3.1 Gen1 and allowing video resolution capabilities up to 4K@60Hz at 4:4:4.

The device is designed to be a centerpiece of any collaboration space, and can be connected to USB peripherals via USB-A type connectors. The series allows the hosts to be connected to the system and also ensures quick and easy switching between these hosts, making this universal switcher a perfect fit for smaller meeting areas, involving 6-12 people.



The UCX-4x2-HC30D, UCX-4x2-HC40D and UCX-4x3-HC40-BD models also thrive when it comes to audio capabilities, offering analog audio de-embedding feature, as well as support for DANTE/AES67 network connection to send DANTE/AES67 audio stream directly to a dedicated audio system. See more details in the [Dante® Audio Interface](#) section.



Dante® is a registered trademark of Audinate Pty Ltd.

Model Denomination

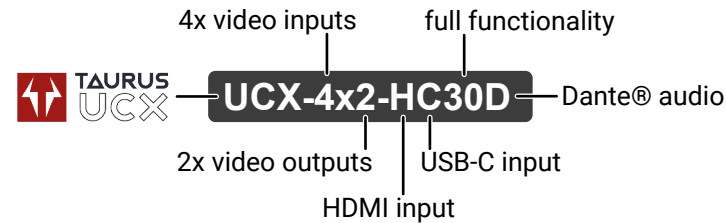





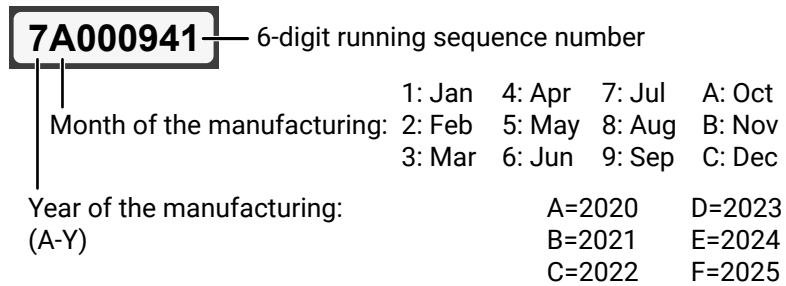





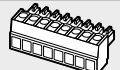
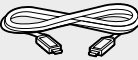

About the Serial Number

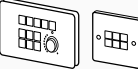
Lightware devices contain a label indicating the unique serial number of the product. The structure is the following:

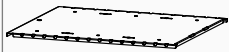

1.2. Box Contents

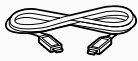
		UCX-2x1-HC30	UCX-2x1-HC40	UCX-2x2-H30	UCX-2x2-H40	UCX-4x2-HC30	UCX-4x2-HC40	UCX-4x2-HC30D	UCX-4x2-HC40D	UCX-4x3-HC40-BD	UCX-4x3-HC40	DCX-2x1-HC10	DCX-3x1-HC20	
Supplied accessories		Switcher unit	✓	✓	✓	✓	✓	✓	✓	✓	✓	✓	✓	
		24V Power Supply Unit with IEC power cable	✓	✓	✓	✓	✓	✓	✓	✓	✓	✓	✓	
		Phoenix combicon® 3-pole flat connector	✓	✓	✓	✓	✓	✓	✓	✓	✓	✓	✗	2x
		Phoenix combicon® 3-pole male connector	✓	✓	✓	✓	✓	✓	✓	✓	✓	✓	✗	✓
		Phoenix combicon® 5-pole connector	✓	✓	✓	✓	✓	✓	✓	✓	✓	✓	✓	✗
		Phoenix combicon® 8-pole connector	✓	✓	✓	✓	✓	✓	✓	✓	✓	✓	✗	✓
		USB 3.1 Type C (USB-C) to Type C (USB-C) Cable, 1m	✓	✓	✗	✗	✓	✓	✓	✓	✓	✓	✓	✓
		Safety & warranty info, Quick Start Guide	✓	✓	✓	✓	✓	✓	✓	✓	✓	✓	✓	✓
		2 pcs. of M3x4 flat head screw	✓	✓	✓	✓	✓	✓	✓	✓	✓	✓	✓	✓
Optional accessories		Button panels: RAP-B511 and TBP6	✓	✓	✓	✓	✓	✓	✓	✓	✓	✓	✓	
		Rack Shelf	✓	✓	✓	✓	✓	✓	✓	✓	✓	✓	✓	
		UD mounting plate F100	✓	✓	✓	✓	✓	✓	✓	✓	✓	✓	✓	
		UD Mounting PSU F100/F110	✓	✓	✓	✓	✓	✓	✓	✓	✓	✓	✓	
		UD Mounting Pro P210	✓	✓	✓	✓	✓	✓	✓	✓	✓	✓	✓	
		UD Mounting PSU Pro 120/130	✓	✓	✓	✓	✓	✓	✓	✓	✓	✓	✓	
		USB 3.1 Type C (USB-C) to Type C (USB-C) Cable, 2m	✓	✓	✓	✓	✓	✓	✓	✓	✓	✓	✓	✓

INFO: The -LCC models have the same values as non-LCC models.

1.3. Features of the Device

Common Features



3D and 4K Support

High bandwidth allows extension of resolutions up to 4K and even 3D sources and displays are supported.



Pixel Accurate Reclocking

Each output has a clean, jitter free signal, eliminating signal instability and distortion caused by long cables or connector reflections.



Frame Detector and Signal Analysis

The exact video and audio signal format can be determined such as timing, frequencies, scan mode, HDCP encryption, color range, color space and audio sample rate.



Autoselect Function for Video and USB Inputs

The Autoselect feature can sense the port status on the video input and USB Host ports and select them automatically. Priority number can be set for each input port, and the feature allows to set various modes for the automatic input selection (First detect, Last detect).



De-embedder Function

The analog audio can be de-embedded from HDMI inputs and it can be routed to the analog audio output.



HDCP-compliant

The switcher fulfills the HDCP standard. HDCP capability on the digital video inputs can be disabled when non-protected content is used.



Dark Mode*

All illuminating elements of the front/rear panel can be switched on and off. This feature is useful in live-stage shows or other environments where flashing LEDs would be distracting.

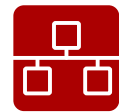

Ethernet Control

Multiple simultaneous TCP/IP connections are available with a simple ASCII-based protocol for controlling or configuring the product, or to perform a firmware update.



Basic IT-security*

These entry-level network security improvements help prevent unauthorized access to the Lightware device; HTTPS/WSS support, basic network authentication.



Bi-directional RS-232*

AV systems can also contain serial port controllers and controlled devices. Serial transmission supports any unit that works with standard RS-232.



GPIO Control Port

Six GPIO pins operating at TTL digital signal levels that can be controlled with LW3 commands. 5V is supplied over the 7th pin constantly, up to 500 mA.



Occupancy Sensor Connector

Occupancy sensor connection (with 24V power supply).



USB 3.1 Switch

The USB 3.1 layer provides switching four external USB peripherals (e.g. webcam, speakerphone, multitouch display, etc.) to four independent host computers or laptops.



Lightware Rest API*

The UCX switcher can be controlled through standard HTTP(S) requests to ensure the control functions from REST clients or terminal program.



Powered by LARA

Future-proof room automation platform for system integrators so they can seamlessly and invisibly support people's collaboration to make the most out of their virtual or in-person meetings.

All -LCC variants (e.g. UCX-2x1-HC40-LCC)

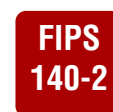

FIPS 140-2 Validation

Lightware Crypto Core delivers core cryptographic functions to the embedded systems of UCX series' hardware devices and features robust algorithm support.

UCX-2x1-HC30, (-HC40), UCX-4x2-HC30, (-HC40), UCX-4x2-HC30D, (-HC40D)



USB Type C Source Connection

USB Type C port ensures USB-C connectivity to the source device with USB 3.1 data and Displayport Alternate mode for video. It provides power delivery of up to 60 W for the connected device (e.g. BYOD laptop or smartphone).

UCX-4x2-HC30D, UCX-4x2-HC40D, UCX-4x3-HC40-BD













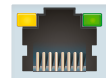

Dante® or AES67 Audio De-embedding

The audio of the HDMI signal can be transmitted as a 2-channel Dante® or AES67 source from the -D model over the dedicated RJ45 connector.

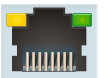
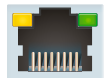
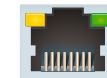
* These functions are available from v1.2.0 firmware package.

1.4. Model Comparison

	AV Interface						USB Interface			Ethernet Interface			Serial Interface	GPIO Interface	OCS Interface
	Inputs			Outputs			USB-A 3.1 Gen1 (5 Gbps)	USB-B 3.1 Gen1 (5 Gbps)	USB-C 3.1 Gen1 (5 Gbps)	Secure Control Ethernet	Utility Ethernet	Configurable Ethernet	RS-232	General Purpose In Out (GPIO)	Occupancy Sensor (OCS)
	Welcome screen option	USB-C 3.1 Gen1 (5 Gbps)	HDMI	HDMI	Analog audio de- embedding	Dante® DANTE/ AES67 audio									
															
UCX-2x1-HC30	✓	1x	1x	1x	✓	-	4x	1x	-	✓	✓	✓	1x	✓	✓
UCX-2x1-HC40	✓	1x	1x	1x	✓	-	4x	1x	-	✓	✓	✓	1x	✓	✓
UCX-2x2-H30	✓	-	2x	2x	✓	-	4x	2x	-	✓	-	-	2x	✓	✓
UCX-2x2-H40	✓	-	2x	2x	✓	-	4x	1x	1x	✓	-	-	2x	✓	✓
UCX-4x2-HC30	✓	2x	2x	2x	✓	-	4x	2x	-	✓	✓	✓	2x	✓	✓
UCX-4x2-HC40	✓	2x	2x	2x	✓	-	4x	1x	1x	✓	✓	✓	2x	✓	✓
UCX-4x2-HC30D	✓	2x	2x	2x	✓	✓	4x	2x	-	✓	✓	✓	2x	✓	✓
UCX-4x2-HC40D	✓	2x	2x	2x	✓	✓	4x	2x	-	✓	✓	✓	2x	✓	✓
UCX-4x3-HC40-BD	✓	2x	2x	3x	✓	✓*	4x	1x	1x	✓	✓	✓	2x	✓	✓
UCX-4x3-HC40	✓	2x	2x	3x	✓	-	4x	1x	1x	✓	✓	✓	2x	✓	✓
DCX-2x1-HC10	-	1x	1x	1x	✓	-	-	-	-	✓	-	-	-	-	-
DCX-3x1-HC20	-	1x	2x	1x	✓	-	-	-	-	✓	✓	✓	✓	✓	✓

* The DANTE audio port is both an input and an output port in case of the UCX-4x3-HC40-BD model.

INFO: The -LCC models have the same values as non-LCC models.

1.5. Typical Application

UCX-4x2-HC30 - Example 1.

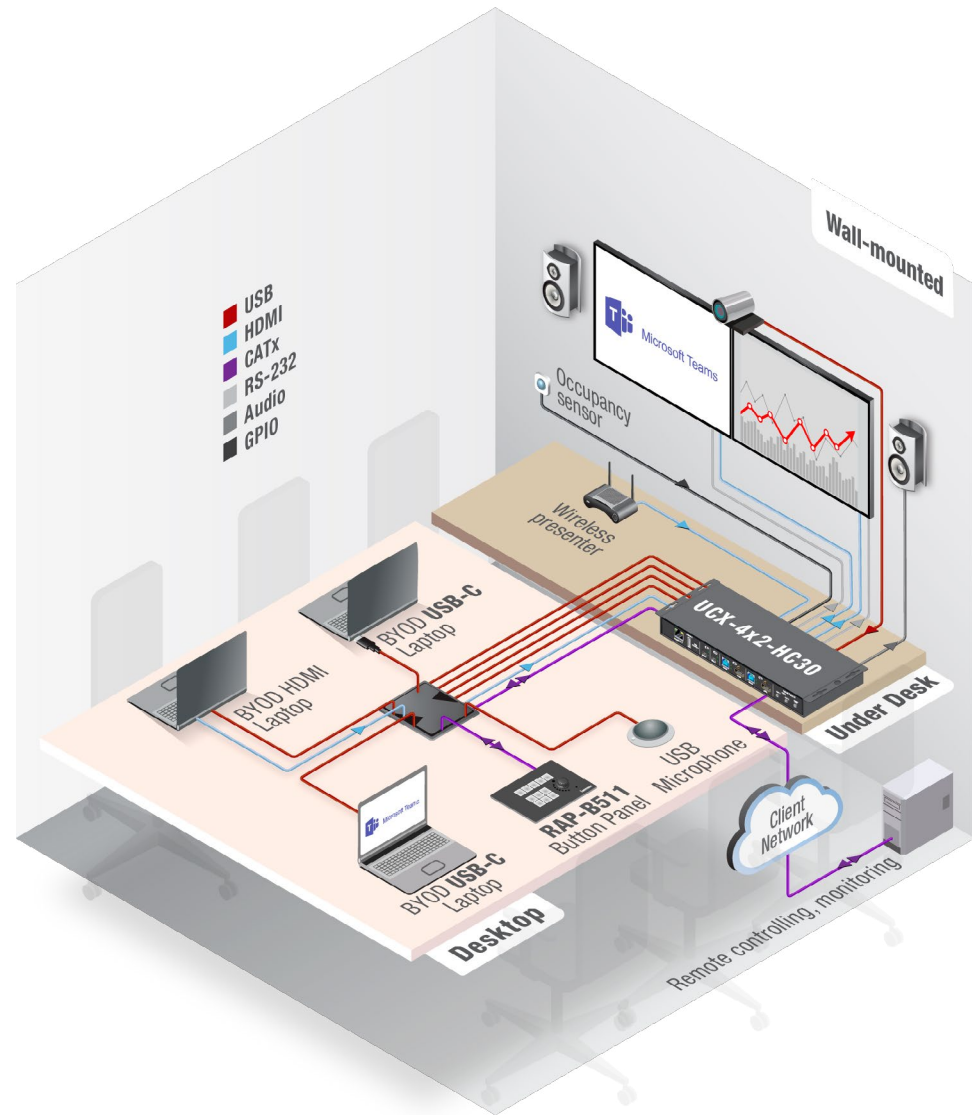

UCX-4x2-HC30 - Example 2.

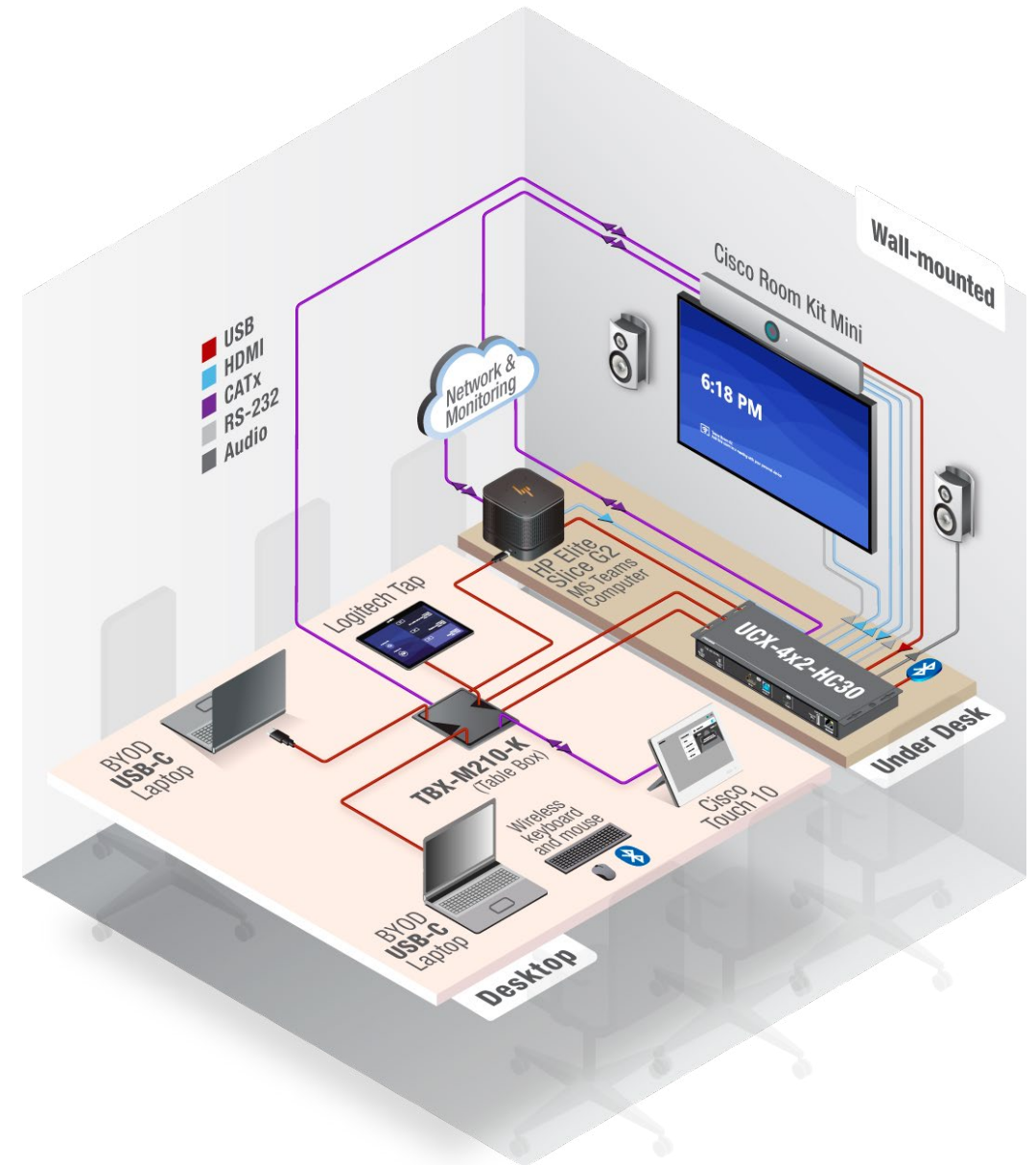

2

Product Overview

The following sections are about the physical structure of the device, input/output ports and connectors:

- ▶ [FRONT VIEW - H\(C\)30 MODELS](#)
- ▶ [FRONT VIEW - H\(C\)40 MODELS](#)
- ▶ [FRONT VIEW - DCX MODELS](#)
- ▶ [REAR VIEW - H\(C\)30 MODELS](#)
- ▶ [REAR VIEW - H\(C\)40 MODELS](#)
- ▶ [REAR VIEW - DCX MODELS](#)

2.1. Front View - H(C)30 Models

UCX-2x1-HC30



UCX-2x2-H30

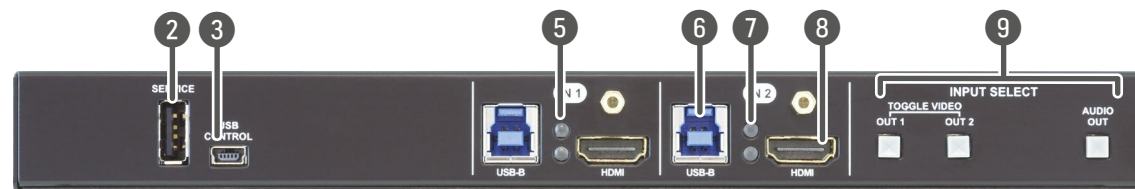

UCX-4x2-HC30

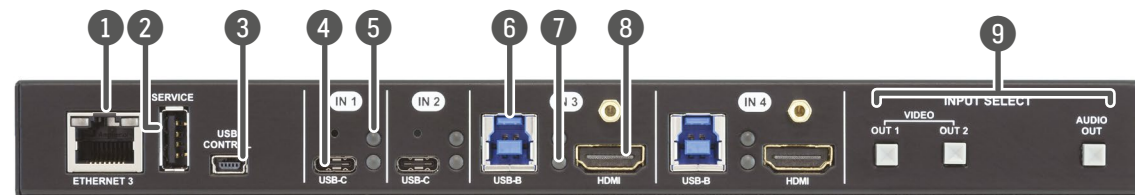

UCX-4x2-HC30D

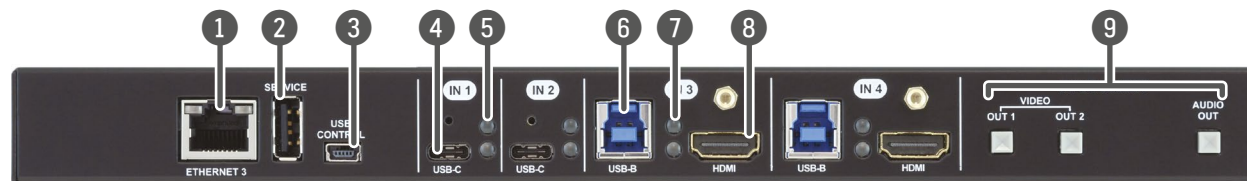

- 1 **Configurable Ethernet Port** RJ45 connector for configurable 100Base-T Ethernet communication.
- 2 **USB-A Port** The firmware update function will be added by a future firmware update.
- 3 **USB mini-B Port** The LW3 control function will be added by a future firmware update.
- 4 **USB-C Ports** Displayport 1.2 and USB 3.1 Gen1 connections, AV signal can be transferred up to a resolution of 4K@60Hz 4:4:4 and data speeds up to 5 Gbps with remote charging. The applied cable shall not be longer than 3m. For more details about the cables, see the [USB-C Cable Recommendation](#) section.
- 5 **Video Input Status LEDs (upper one)** See the details in the [Front Panel LEDs](#) section.
- 6 **USB-B Ports** Upstream ports for connecting USB host devices (e.g. computer).
- 7 **USB Status LEDs (below one)** See the details in the [Front Panel LEDs](#) section.
- 8 **HDMI Input Ports** HDMI input ports for sources. The applied cable shall not be longer than 5m. Use cables certified for HDMI 2.0 (3x6Gbps) applications.
- 9 **Input Select Buttons** For more details, see the [Button Functionality](#) section. When LEDs blink green three times after pressing the button, they show that the front panel lock is enabled.

INFO: Connecting USB-B and HDMI ports to the same PC or laptop is recommended in case of IN3 and IN4 inputs.

2.2. Front View - H(C)40 Models

UCX-4x3-HC40

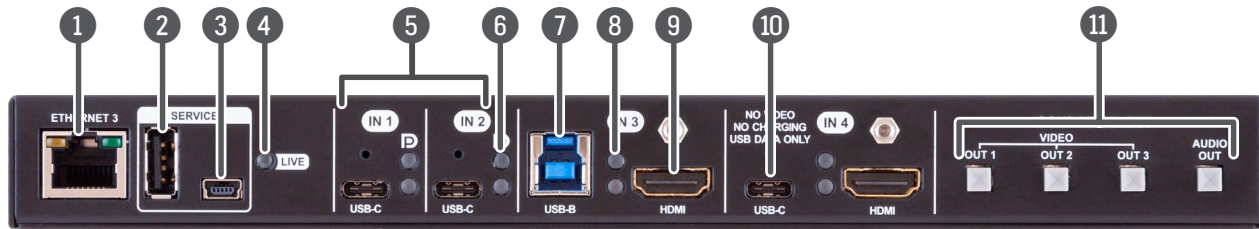

UCX-2x1-HC40

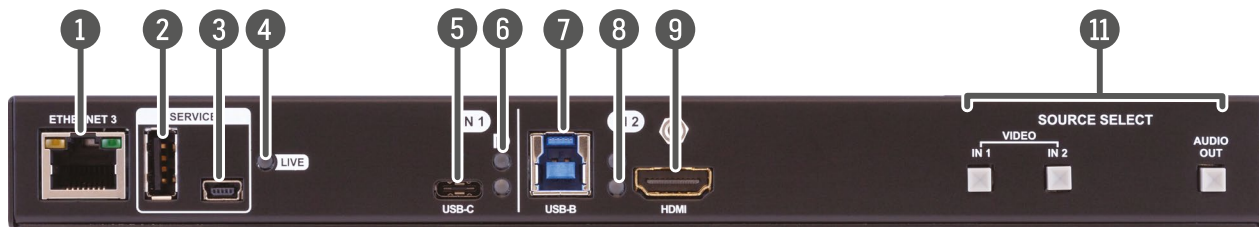

UCX-2x2-H40

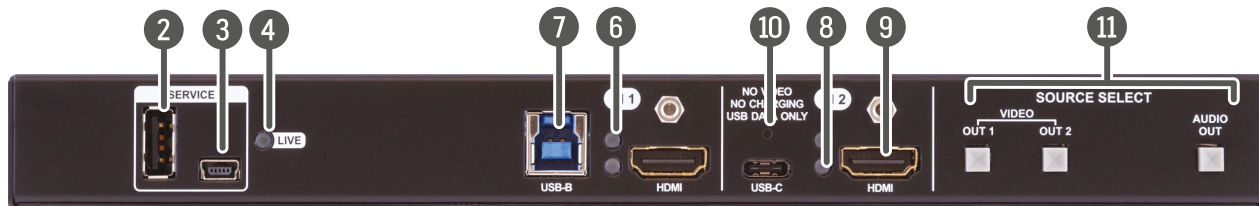

UCX-4x2-HC40

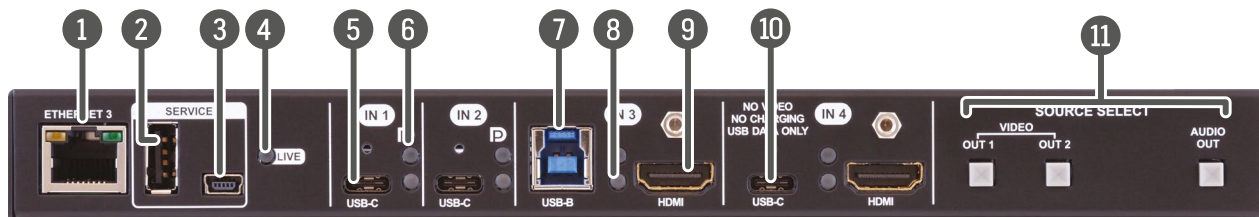

UCX-4x2-HC40D #new

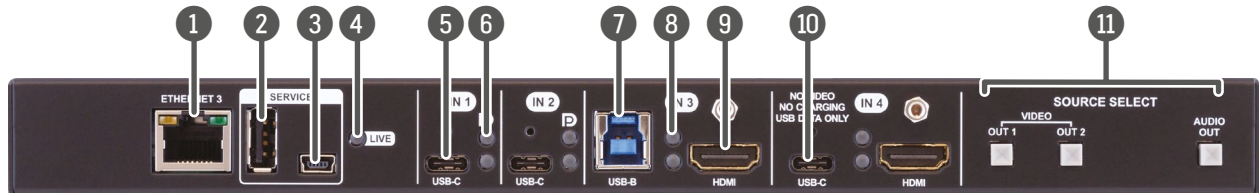

UCX-4x3-HC40-BD

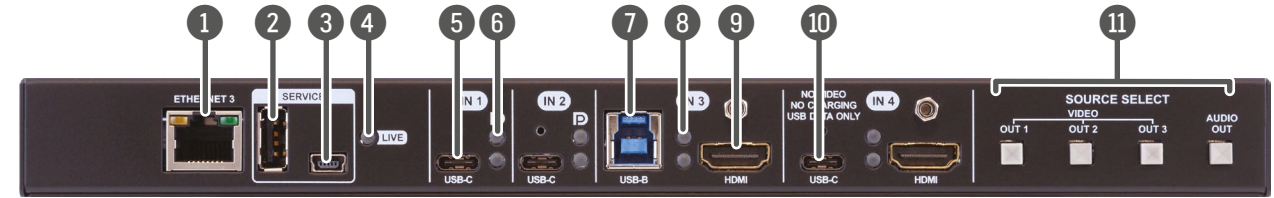

- 1 **Configurable Ethernet Port** RJ45 connector for configurable 100Base-T Ethernet communication.
- 2 **USB-A Port** The SERVICE-labelled USB-A connector is designed for service functions.
- 3 **USB mini-B Port** The SERVICE-labelled USB mini-B port is designed for service functions.
- 4 **LIVE LED** See the details in the [Front Panel LEDs](#) section.
- 5 **USB-C Ports** AV signal can be transferred up to a resolution of 4K@60Hz 4:4:4 and data speeds up to 5 Gbps with remote charging. Use cables certified for USB 3.1 Gen1 (5Gbps) and Displayport Alternate mode HBR2 (4x5.4Gbps) applications.
- 6 **Video Input Status LEDs** See the details in the [Front Panel LEDs](#) section.
- 7 **USB-B Port** Upstream ports for connecting USB host devices (e.g. computer).
- 8 **USB Status LEDs** See the details in the [Front Panel LEDs](#) section.
- 9 **HDMI Input Ports** HDMI input ports for sources. The applied cable shall not be longer than 5m. Use cables certified for HDMI 2.0 (3x6Gbps) applications.
- 10 **USB-C Data Port** USB-C port for USB data transmission only.
- 11 **Input Select Buttons** For more details, see the [Button Functionality](#) section. When LEDs blink green three times after pressing the button, they show that the front panel lock is enabled.

INFO: The -LCC models have the same physical attributes as non-LCC models.

2.3. Front View - DCX Models

DCX-2x1-HC10



DCX-3x1-HC20 #new

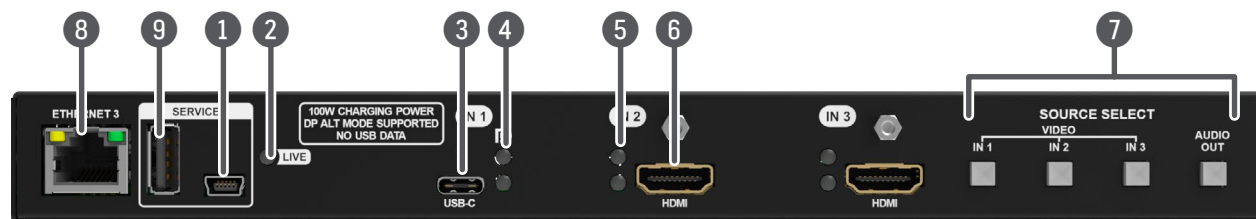

- | | | |
|---|-----------------------------------|---|
| 1 | USB mini-B Port | The SERVICE-labelled USB mini-B port is designed for service functions. |
| 2 | LIVE LED | See the details in the Front Panel LEDs section. |
| 3 | USB-C Ports | AV signal can be transferred up to a resolution of 4K@60Hz 4:4:4 and data speeds up to 5 Gbps with remote charging. Use cables certified for USB 3.1 Gen1 (5Gbps) and Displayport Alternate mode HBR2 (4x5.4Gbps) applications. |
| 4 | Video Input Status LEDs | See the details in the Front Panel LEDs section. |
| 5 | Video Input Status LEDs | See the details in the Front Panel LEDs section. |
| 6 | HDMI Input Ports | HDMI input ports for sources. The applied cable shall not be longer than 5m. Use cables certified for HDMI 2.0 (3x6Gbps) applications. |
| 7 | Input Select Buttons | For more details, see the Button Functionality section. When LEDs blink green three times after pressing the button, they show that the front panel lock is enabled. |
| 8 | Configurable Ethernet Port | RJ45 connector for configurable 100Base-T Ethernet communication. |
| 9 | USB-A Port | The SERVICE-labelled USB-A connector is designed for service functions. |

2.4. Rear View - H(C)30 Models

UCX-2x1-HC30

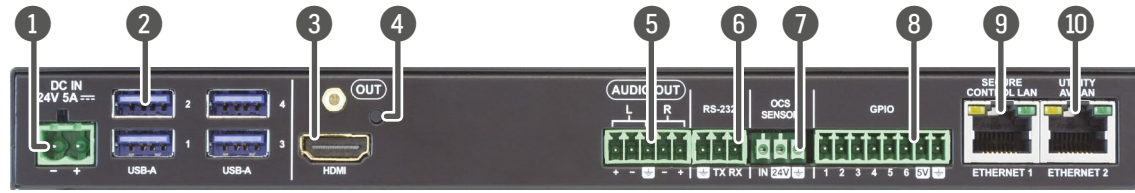

UCX-2x2-H30

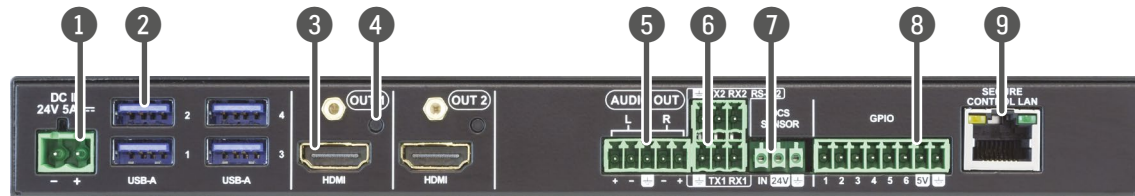

UCX-4x2-HC30

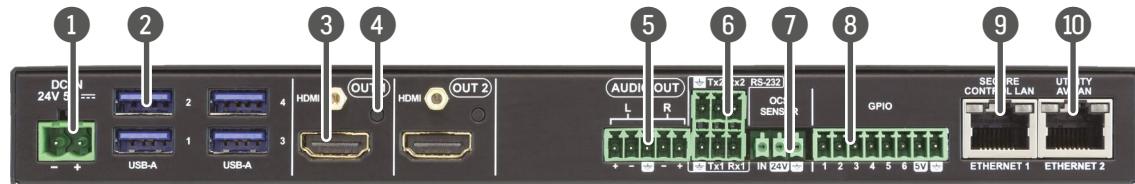

UCX-4x2-HC30D

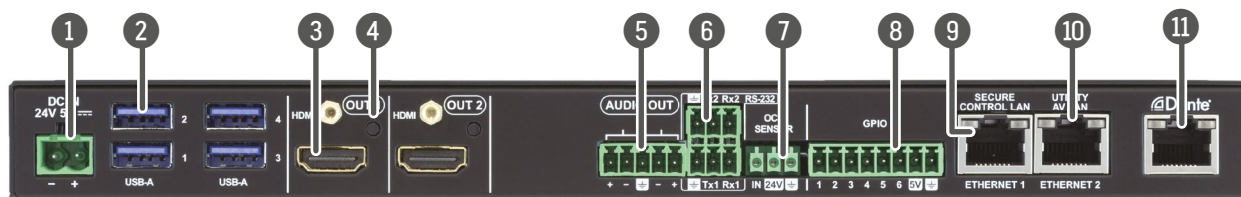

- 1 **DC Input** The device can be powered by an external 120W power supply. Connect the output to the 2-pole Phoenix® connector. For more info about the powering, see the [Powering Options](#) section.
- 2 **USB-A Port** Downstream ports for connecting USB peripherals (e.g. camera, keyboard, multitouch display) with USB 3.1 Gen1 data speed.
- 3 **HDMI Output Ports** HDMI output ports for connecting sink devices.
- 4 **Video Output Status LEDs** See the details in the [section](#).
- 5 **Analog audio port** 5-pole Phoenix® connector for balanced analog audio output signal. The signal is de-embedded from the selected video signal.
- 6 **RS-232 port** 3-pole Phoenix® connector for bi-directional RS-232 communication.
- 7 **OCS sensor connector** 3-pole Phoenix® connector (male) for connecting an occupancy sensor. The port provides 24V output voltage (50mA), see the details in the [OCS Connector](#) section.
- 8 **GPIO** 8-pole Phoenix® connector for configurable general purpose. Max. input/output voltage is 5V, see the details in the [GPIO - General Purpose Input/Output Ports](#) section.
- 9 **Secure Control LAN** RJ45 connector for configurable 100Base-T Ethernet communication.
- 10 **Utility AV LAN** RJ45 connector provides room utility Ethernet connection for e.g BYOD laptops.
- 11 **Dante® Audio Output** RJ45 connector for de-embedding the HDMI audio, which can be transmitted as a 2-channel Dante® or AES67 source.

WARNING! Always use the supplied power supply. Warranty void if damage occurs due to use of a different power source.

WARNING! The occupancy sensor connector and the GPIO port are not compatible with each other due to voltage level difference, please do not connect them directly.

2.5. Rear View - H(C)40 Models

UCX-4x3-HC40

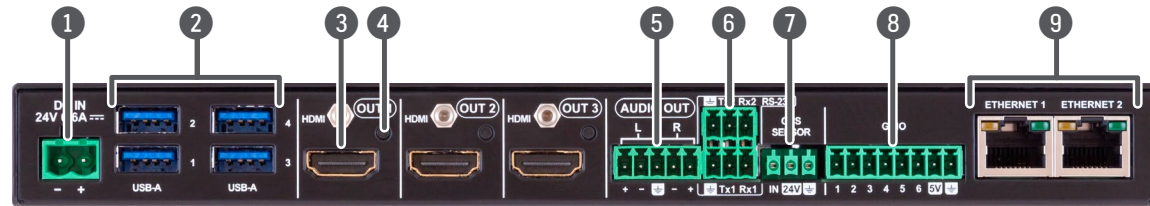

UCX-2x1-HC40

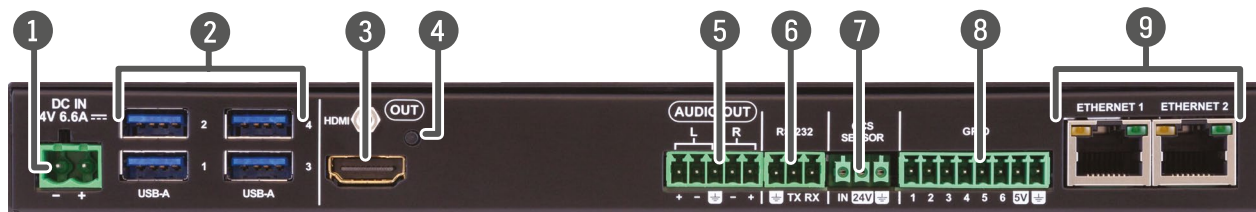

UCX-2x2-H40

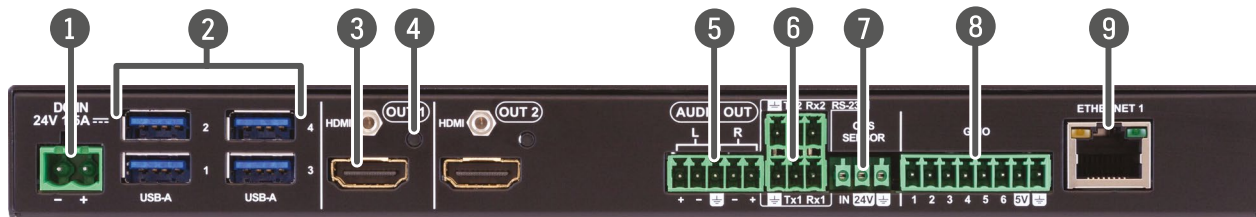

UCX-4x2-HC40

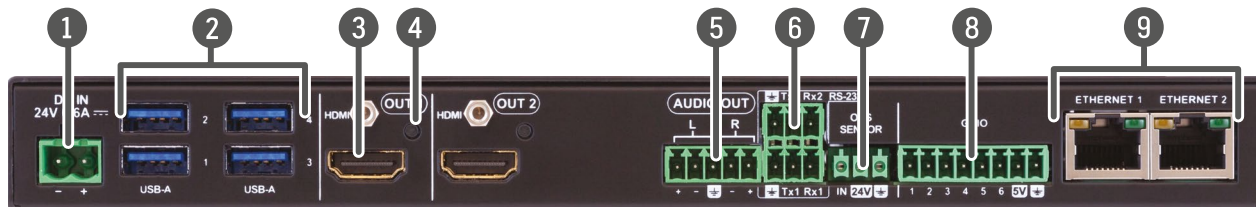

UCX-4x2-HC40D #new

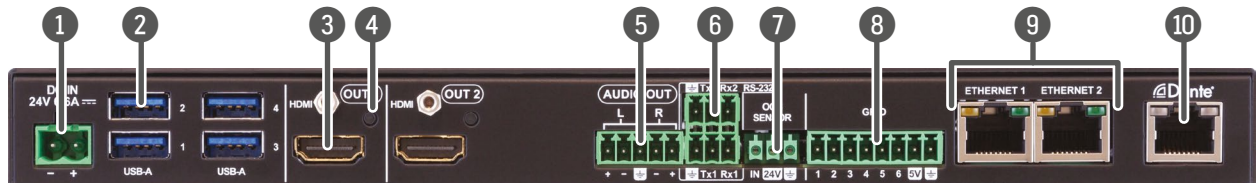

UCX-4x3-HC40-BD

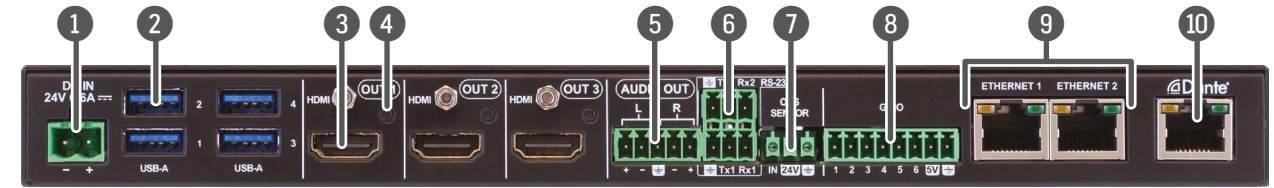

- 1 DC Input** The device can be powered by an external 160W power supply. Connect the output to the 2-pole Phoenix® connector. For more info about the powering, see the [Powering Options](#) section.
- 2 USB-A Ports** Downstream ports for connecting USB peripherals (e.g. camera, keyboard, multitouch display) with USB 3.1 Gen1 data speed.
- 3 HDMI Output Port(s)** HDMI output port(s) for connecting sink devices (e.g. displays).
- 4 Video Output Status LEDs** See the details in the [Rear Panel LEDs](#) section.
- 5 Analog Audio Port** 5-pole Phoenix® connector for balanced analog audio output signal. The signal is de-embedded from the selected video signal.
- 6 RS-232 Port** 3-pole Phoenix® connector for bi-directional RS-232 communication.
- 7 OCS Sensor Connector** 3-pole Phoenix® connector (male) for connecting an occupancy sensor. The port provides 24V output voltage (50mA), see the details in the [OCS Connector](#) section.
- 8 GPIO** 8-pole Phoenix® connector for configurable general purpose. Max. input/output voltage is 5V, see the details in the [GPIO - General Purpose Input/Output Ports](#) section.
- 9 Configurable Ethernet Port(s)** RJ45 connector(s) for configurable 100Base-T Ethernet communication.
- 10 Dante® Audio port** RJ45 connector for de-embedding the HDMI audio, which can be transmitted as a 2-channel Dante® or AES67 source. In case of UCX-4x3-HC40-BD, it can also handle incoming signal from a Dante source without the need for an external DSP or Dante/USB dongle.

INFO: The -LCC models have the same physical attributes as non-LCC models.

2.6. Rear View - DCX Models

DCX-2x1-HC10

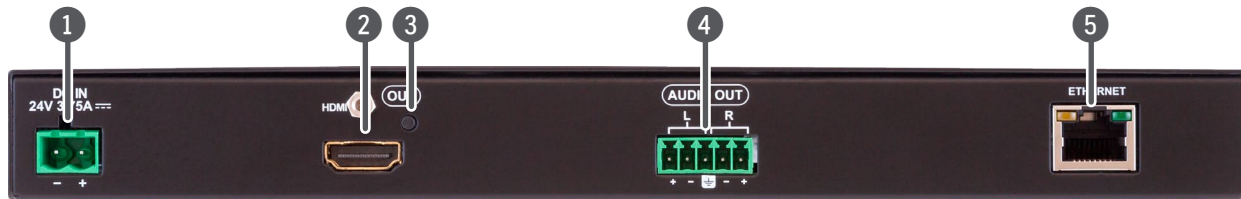

DCX-3x1-HC20 *#new*

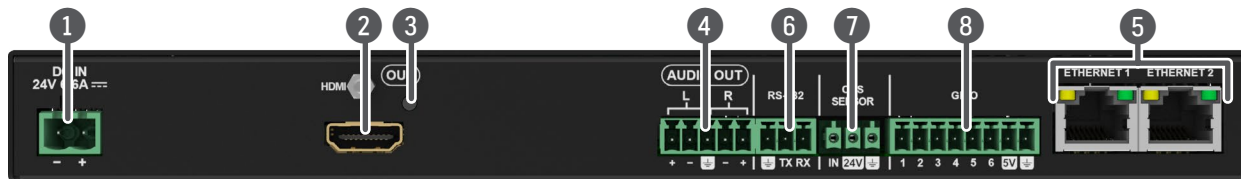

- 1 DC Input**

The device can be powered by an external 120W power supply. Connect the output to the 2-pole Phoenix® connector. For more info about the powering, see the [Powering Options](#) section.
- 2 HDMI Output Port**

HDMI output port for connecting sink devices (e.g. displays).
- 3 Video Output Status LEDs**

See the details in the [Rear Panel LEDs](#) section.
- 4 Analog Audio Port**

5-pole Phoenix® connector for balanced analog audio output signal. The signal is de-embedded from the selected video signal.
- 5 Configurable Ethernet Port(s)**

RJ45 connector(s) for configurable 100Base-T Ethernet communication.
- 6 RS-232 Port**

3-pole Phoenix® connector for bi-directional RS-232 communication.
- 7 OCS Sensor Connector**

3-pole Phoenix® connector (male) for connecting an occupancy sensor. The port provides 24V output voltage (50mA), see the details in the [OCS Connector](#) section.
- 8 GPIO**

8-pole Phoenix® connector for configurable general purpose. Max. input/output voltage is 5V, see the details in the [GPIO - General Purpose Input/Output Ports](#) section.

3

Front Panel Control

The following sections are about front panel operation of the device and the status LEDs:

- ▶ [BUTTON FUNCTIONALITY](#)
- ▶ [STATUS LEDs](#)

3.1. Button Functionality

INFO: If the control lock is enabled and a button is pressed, front panel LEDs blink 3 times quickly.

INFO: The -LCC models have the same values as non-LCC models.

3.1.1. Video Source Selection

UCX-2x1-HC30 , UCX-2x1-HC40, DCX-2x1-HC10

Use the **IN1** and **IN2** buttons to select the video source. **IN1** button switches the USB-C IN1 to the output, the **IN2** button switches the HDMI IN2 to the output.

Use the **AUDIO OUT** button to set the audio source of the analog audio output.

The sequence is the following (for the audio switching):

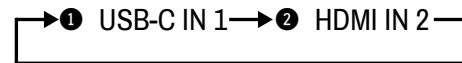

DCX-3x1-HC20 #new

Use the **IN1**, **IN2** and **IN3** buttons to select the video source. **IN1** button switches the USB-C IN1 to the output, the **IN2** button switches the HDMI IN2 to the output, and the **IN3** button switches the HDMI IN3 to the output.

Use the **AUDIO OUT** button to set the audio source of the analog audio output.

The sequence is the following (for the audio switching):

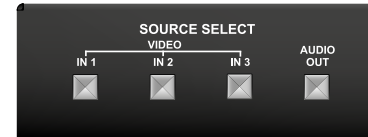

UCX-2x2-H30, UCX-2x2-H40

Use the **OUT1** and **OUT2** buttons to select the video source. Push **OUT1** to select the video input for the HDMI OUT1 port, the **OUT2** button switches the video input for the HDMI OUT2 port.

Use the **AUDIO OUT** button for selecting the audio source of the analog audio output.

The sequence is the following (both for the video and audio switching):

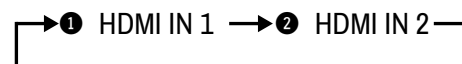

UCX-4x2-HC30, UCX-4x2-HC30D, UCX-4x2-HC40, UCX-4x2-HC40D

Push **OUT1** to select the video input for the HDMI OUT1 port.

Push **OUT2** to select the video input for the HDMI OUT2 port.

Push **AUDIO OUT** to set the audio source of the analog audio output.

The sequence is the following (both for the video and audio switching): #switch #crosspoint

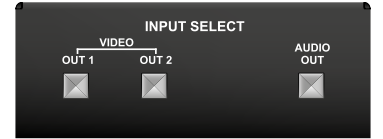
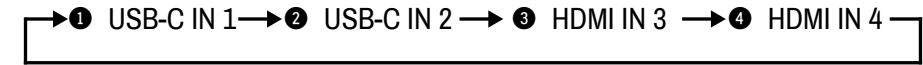

UCX-4x3-HC40, UCX-4x3-HC40-BD

Push **OUT1** to select the video input for the HDMI OUT1 port.

Push **OUT2** to select the video input for the HDMI OUT2 port.

Push **OUT3** to select the video input for the HDMI OUT3 port.

Push **AUDIO OUT** to set the audio source of the analog audio output.

The sequence is the following (both for the video and audio switching): #switch #crosspoint

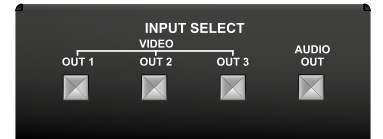
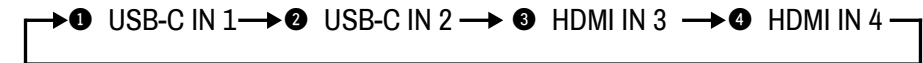

3.1.2. Enabling DHCP IP Address

DIFFERENCE: This function is available from v1.2.0 firmware package.

The device has a dynamic IP address as a factory default setting. If it is set to static IP address during install or usage, dynamic IP address can be enabled from the front panel:

Step 1. Make sure the device is powered on and operational.

Step 2. Press and keep pressing the **AUDIO OUT** button for 5 seconds.

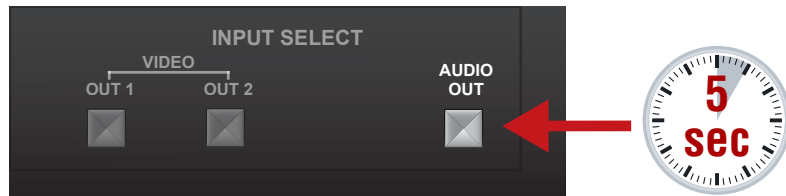

Step 3. After 5 seconds the front panel LEDs start blinking; release the button and press it 3 times again quickly (within 3 seconds).

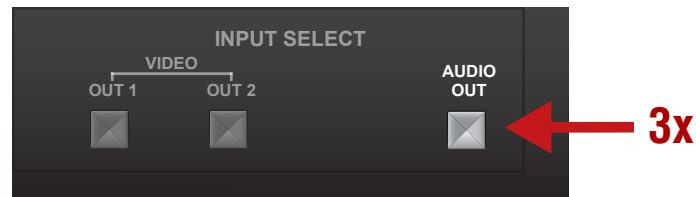

Step 4. The LEDs get dark, DHCP gets enabled. `#dhcp`

3.1.3. Reset to Factory Default Settings

There are two ways to restore the factory default settings: `#factory`

3.1.3.1. Factory Default By Pressing VIDEO OUT 2 (VIDEO IN2) Button

DIFFERENCE: This method refers to devices with FW package v1.0.x or v1.1.x.

To restore factory default values, do the following steps:

Step 1. Make sure the switcher is powered off.

Step 2. Power on the switcher while the **VIDEO OUT2** (**VIDEO IN2** in UCX-2x1-HC30 and DCX-2x1-HC10 models) is being pressed for 10 seconds. The device restores the factory default settings and reboots.

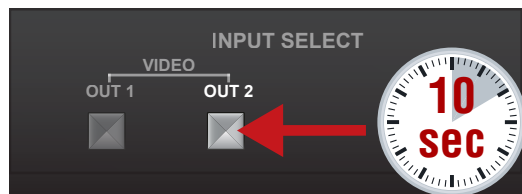

3.1.3.2. Factory Default By Pressing AUDIO OUT button

DIFFERENCE: This function is available from FW package v1.2.0.

To restore factory default values, do the following steps:

Step 1. Make sure the device is powered on and operational.

Step 2. Press and keep pressing the **AUDIO OUT** button for 10 seconds.

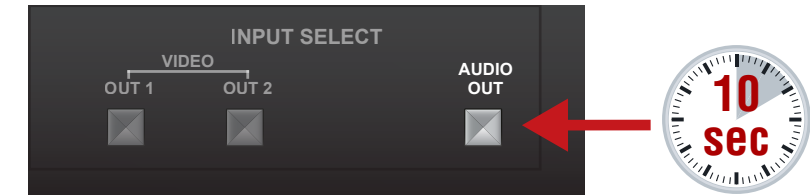

Step 3. After 5 seconds the front panel LEDs start blinking, but keep on pressing the button.

Step 4. After 10 seconds the LEDs start blinking faster; release the button and press it 3 times again quickly (within 3 seconds).

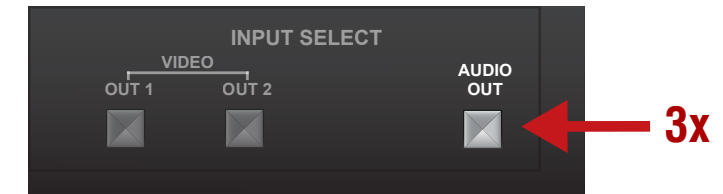

Step 5. The LEDs get dark, the device restores the factory default settings and reboots.

Factory default settings are listed in the [Factory Default Settings](#) section.

3.1.4. Control Lock

Press the **VIDEO OUT1** (**VIDEO IN1** in UCX-2x1-HC30, UCX-2x1-HC40 and DCX-2x1-HC10 models) and **AUDIO OUT** buttons **together** (within 100 ms) to disable/enable front panel buttons; front panel LEDs blink 4 times when locking/unlocking. If the control lock is enabled and a button is pressed, front panel LEDs blink 3 times quickly.

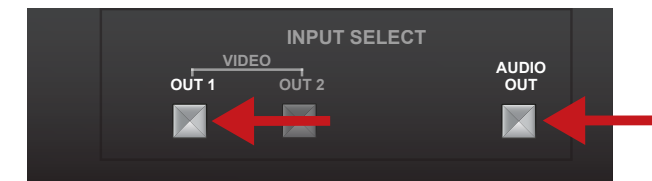

3.2. Status LEDs

INFO: When Dark mode is enabled, no LEDs are lit, even though the device is fully functional. For more details about the dark mode, see the [Status](#) section.

INFO: The -LCC models have the same values as non-LCC models.

3.2.1. Front Panel LEDs

Live LED

DIFFERENCE: UCX-2x1-HC30, UCX-2x2-H30, UCX-4x2-HC30 and UCX-4x2-H30D models do not have a Live LED.

LIVE LED		
	blinking	The device is powered on and operational.
	off	The device is not powered or out of operation.

Arrangement of the status LEDs #status

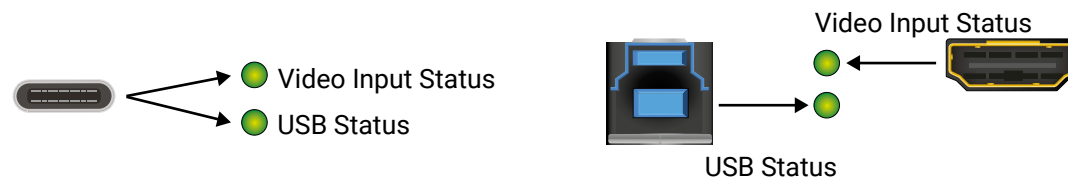

Video Input Status LED (the upper one)		
	off	There is no valid video signal on this port.
	on	There is a valid video signal on this port.
	blinks once	The port is selected by a button press.
USB Status LED (the lower one)		
	off	No USB Host or deselected port.
	on	USB Host connected and selected.

3.2.2. Rear Panel LEDs

Video Output Status		
	off	The signal is not present or muted.
	on	The video signal is present.

3.2.3. Ethernet Status LEDs



DIFFERENCE: The color of the left Ethernet LED is red up to v2.0 hardware version. It does not refer to any error, On/Off/Blinking state indicates the same function as the left green one (above v.2.1) The hardware version can be found in the [Status](#) menu in the LDC.

Left LED color	HW version
	Up to v2.0
	v2.1 and above

LED state	Left LED	Function
	Off	Not linked
	On (Solid)	No activity
	Blinking	Activity
LED state	Right LED	Function
	Off	0 Mbit/s
	On (Solid)	100 Mbit/s

3.2.4. Dante® Audio Port (UCX-4x2-HC30D, UCX-4x2-HC40D models)

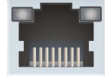
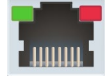
DIFFERENCE: UCX-4x2-HC30D and UCX-4x2-HC40D models have Dante® Audio Output.

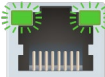
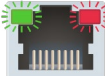
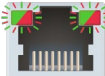
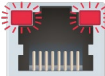
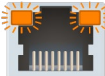
LED state	Left LED	Right LED	Function
	Off	Off	No power
	Solid green	Solid red	Dante is booting
	Blinking green	Solid green	Slave with sync (normal operation)
	Blinking green	Blinking green	Clock master (normal operation)
	Blinking green	Blinking red	Acquiring clock sync (normal operation)
	Alternating red/green	Alternating red/green	Identify (blinking for 6 seconds)
	Blinking red	Blinking red	Dante fail safe
	Blinking orange	Blinking orange	Dante is upgrading

3.2.5. Dante® Audio Port (UCX-4x3-HC40-BD model)

DIFFERENCE: UCX-4x32-HC30D model has Dante® Audio port.

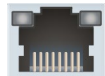
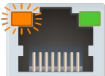
LED state	Left LED	Right LED	Function
	Off	Off	No power
	Blinking orange	Solid green	Normal operation

4

Installation

This chapter is about the installation of the device and connecting to other appliances, presenting also the mounting options and further assembly steps.

- ▶ [MOUNTING OPTIONS](#)
- ▶ [ELECTRICAL CONNECTIONS](#)
- ▶ [POWERING OPTIONS](#)
- ▶ [POWER DELIVERY OVER TYPE-C](#)
- ▶ [USB-C CABLE RECOMMENDATION](#)
- ▶ [CONNECTING STEPS](#)

4.1. Mounting Options

To mount the switcher, Lightware supplies optional accessories for different usage. There are two kinds of mounting kits with a similar fixing method. The switcher has two mounting holes with inner thread on the bottom side; see the bottom view in the [Mechanical Drawings](#) section. To order mounting accessories, please contact sales@lightware.com. Fasten the device with the screws enclosed to the accessory.

WARNING! Always use the supplied screws. Using different (e.g. longer) ones may cause damage to the device.

Ventilation

WARNING! Never block the ventilation holes on any side of the switcher! Ensure proper ventilation by letting the air flow freely.

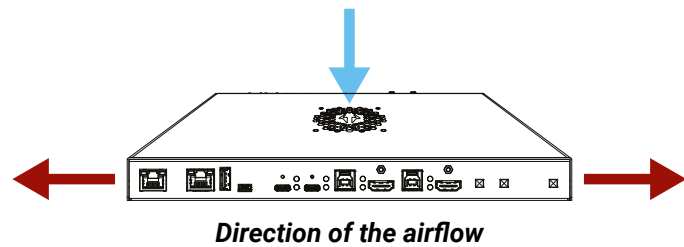

4.1.1. 1U High Rack Shelf

Allows rack mounting for half-rack, quarter-rack and pocket sized units.



1U high rack shelf provides mounting holes for fastening two half-rack or four quarter-rack sized units. Pocket-sized devices can also be fastened to the shelf.

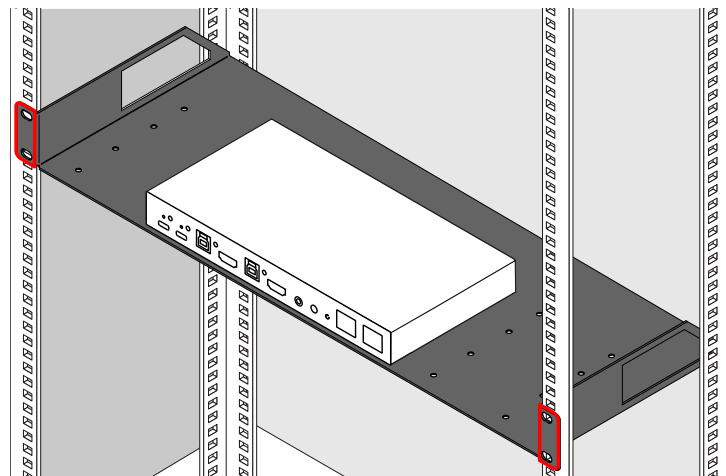

4.1.2. Mounting Plate F100 (and PSU F100/F110)

DIFFERENCE: The following accessories can be purchased optionally, please contact sales@lightware.com.



Mounting Plate F100 and PSU F100

The examples demonstrate the applications of the UD Kit accessories:

Step 1. Turn the switcher and the power adaptor upside down.

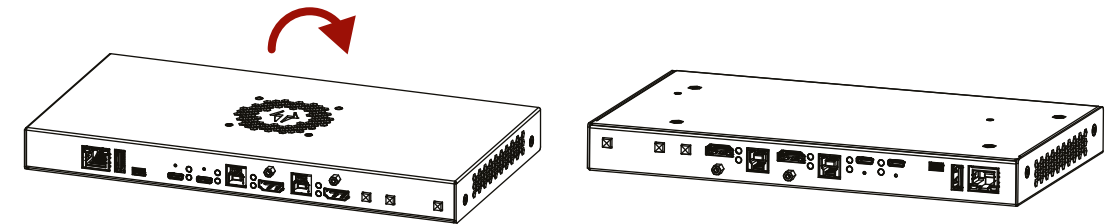

Step 2. Fix the UD Mounting plate F100 to the switcher by fastening the screws (2 pcs screws are supplied with the switcher).

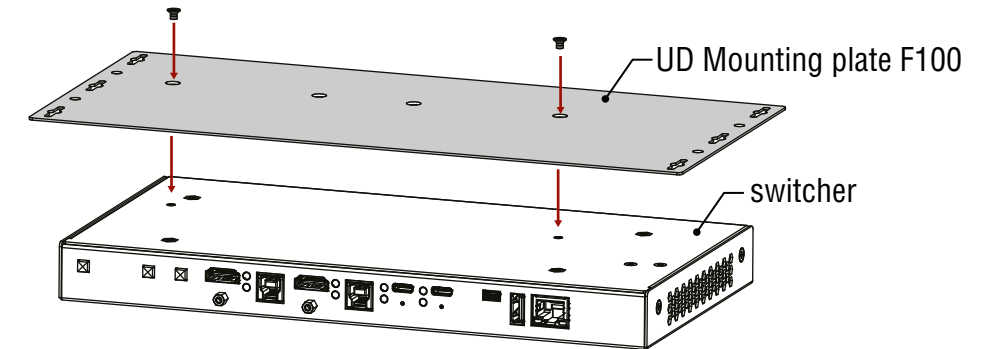

Step 3. Insert the power supply into the UD Mounting PSU F100.

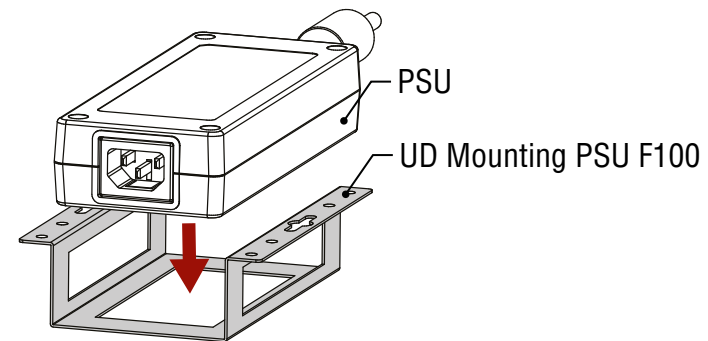

Step 4. Fix the UD Mounting plate F100 and UD Mounting PSU F100/F110 under the desk by fastening the screws.

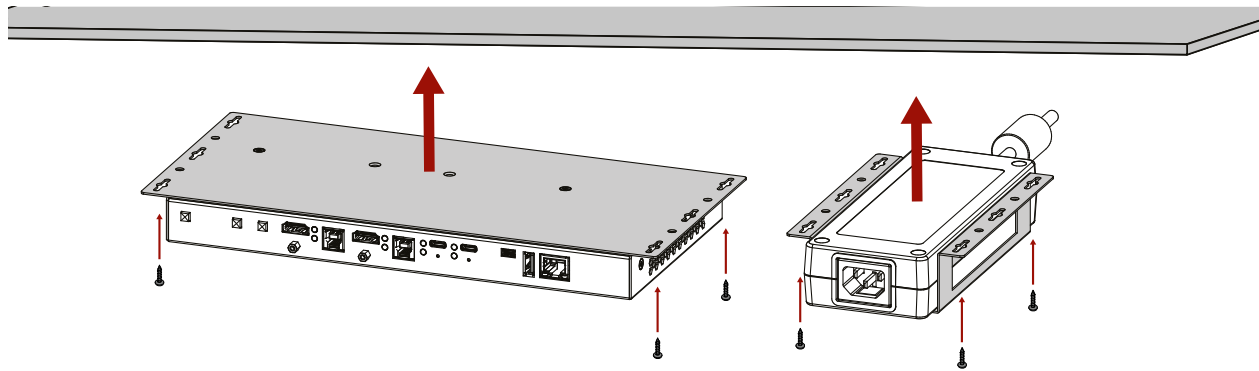

INFO: UD Mounting plate F100 and UD Mounting PSU F100/F110 do not contain the fixing screws; they can be purchased from the local hardware store. 2x4pcs M3-M5 metric or wood screws are needed, M3 size is recommended.

The UD Mounting PSU F100 is made for mounting a 160W PSU; for mounting a 120W PSU, you will need the UD Mounting PSU F110.

ATTENTION! To ensure the correct ventilation and avoid overheating, insert the switcher face down to the UD Mounting plate F100 to keep the ventilation holes free.

DIFFERENCE: From FW package v1.2.0 the fan rotates only when the device is warm, otherwise not.

4.1.3. UD Mounting Pro P210 (and P120/P130)

The UD Mounting Pro P210 plate makes it easy to mount a single device on any flat surface (e.g. a piece of furniture). UD mounting Pro P120/P130 plate is to mount a PSU on any flat surface.

ATTENTION! The dimensions of the actual PSU's are different. UD mounting Pro120 is for fixing the PSU-24VP3-160, and UD mounting Pro 130 is for fixing the PSU-24VP3-120.



Step 1. Turn the switcher and the PSU upside down.

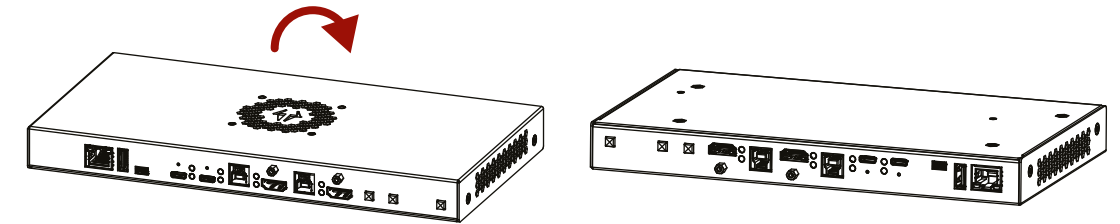

Step 2. Fix the UD Mounting Pro P210 to the switcher by fastening the screws (these 2 pcs screws are supplied with the switcher).

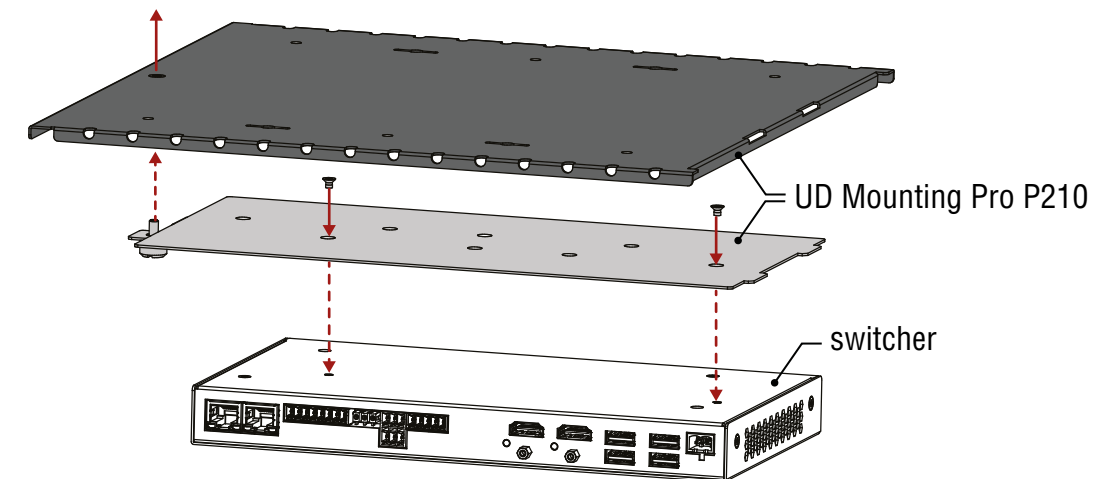

Step 3. Insert the power supply into the UD Mounting Pro P120/P130.

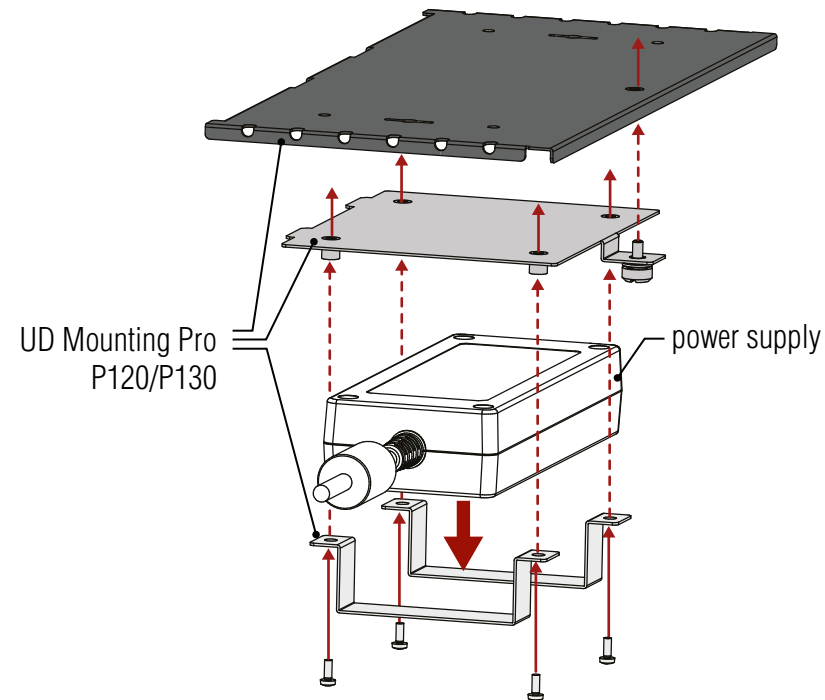

Step 4. Fix the UD Mounting Pro 210 and UD Mounting Pro P120/P130 under the desk by fastening the screws.

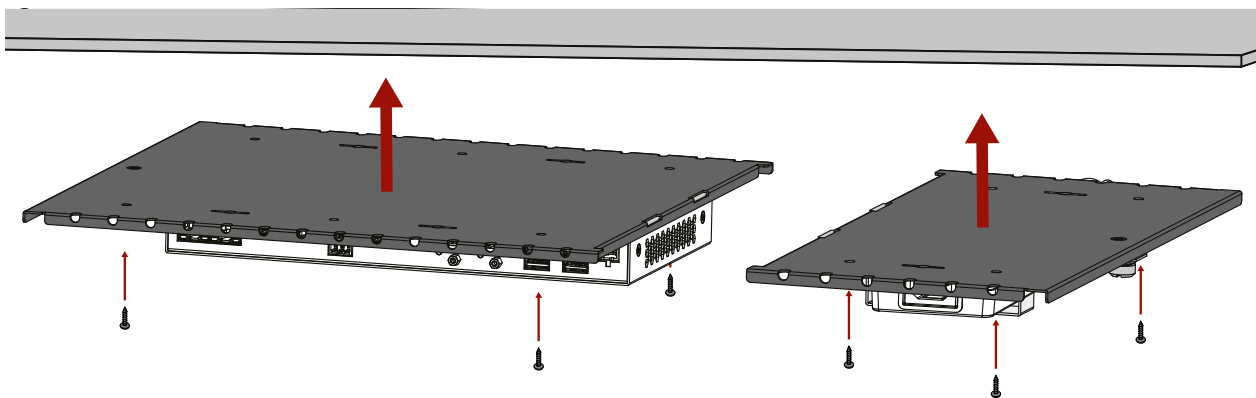

INFO: UD Mounting Pro P210 and UD Mounting Pro P120/P130 do not contain the fixing screws; they can be purchased from the local hardware store. 2x4pcs M3-M5 metric or wood screws are needed, M3 size is recommended.

ATTENTION! To ensure the correct ventilation and avoid overheating, insert the switcher face down to the UD Mounting Pro P210 to keep the ventilation holes free.

4.1.4. C-Lock

The USB-C Cable Lock is a product designed to enhance the security and reliability of a physical connection by providing a 2-point securing option for connected USB-C cables. *#new*

Step 1. Plug the USB-C cable in.

Step 2. Fix the C-Lock with the M2 screw.

Step 3. Use the provided zip ties to fasten the flange to the USB-C connector.



4.2. Electrical Connections

4.2.1. HDMI Input and Output Ports

The UCX series switchers are assembled with standard 19-pole HDMI connectors with screw lock for inputs and outputs. Always use high quality HDMI cables for connecting sources and displays.

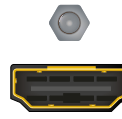

4.2.2. USB Connectors

USB Type-C

ATTENTION! The USB-C ports of Taurus are developed to connect native USB-C sources. HDMI-USB-C or DP-USB-C adapters are not supported and not recommended to apply.



The switchers are supplied with USB 3.1 Gen1 (max. 5 Gbps data speed) USB C-type port for video, USB data, and Ethernet transmission. It provides power delivery for a max. of two connected devices up to 60W or 2 x 30W. Supported power profiles: 5V/3A, 9V/3A, 12V/3A, 15V/2A, 15V/3A, 20V/1.5A, 20V/3A. USB-C connector has symmetrical plug and pin layout.

ATTENTION! USB 2.x and 3.x data transfer happens on two independent layers simultaneously.

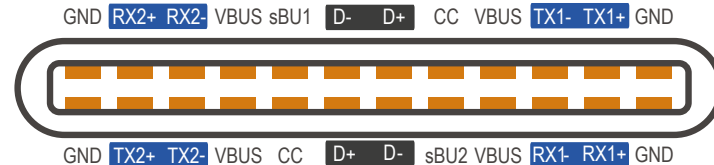

■ SuperSpeed Data Transfer for USB 3.x and USB 4
 ■ High Speed Data Transfer for USB 2.0 and USB 1.1

The pinout of the USB-C connector

DIFFERENCE: The USB-C connector of the DCX-2x1-HC10 and DCX-3x1-HC20 models does not transmit USB data and Ethernet.

DIFFERENCE: In UCX-4x2-HC40, UCX-4x3-HC40, UCX-4x2-HC40D and UCX-4x3-HC40-BD the P4 USB-C port does not transmit video, Ethernet or remote power, only USB data. The same applies to the USB-C port of the UCX-2x2-H40 model.

ATTENTION! USB-C functionality and speed depend on the cable and the device. Mandatory features of the USB-C - USB-C cables are: USB 2.0 (480 Mbps), min. 3A current, min. 60W power.

USB Type-A



Taurus UCX series have USB 3.1 Gen1 (max. 5 Gbps data speed) USB A-type ports for connecting USB peripherals.



The 5V output power capability can be turned on and off for all ports. All ports are able to supply 1000mA.

■ INFO: The blue color inside the connector refers to the USB 3.0 data speed.

USB Type-B



The switcher is supplied with USB 3.1 Gen1 (max. 5 Gbps data speed) B-type ports for connecting USB hosts.



■ INFO: The blue color inside the connector refers to the USB 3.0 data speed.

4.2.3. Analog Stereo Audio

A 5-pole Phoenix® connector is used for balanced analog audio output. Unbalanced audio devices can be connected as well. See more details about the balanced and unbalanced output port wiring in the [Cable Wiring Guide](#) section.



Pin nr.	Signal
1	Left+
2	Left-
3	Ground
4	Right-
5	Right+

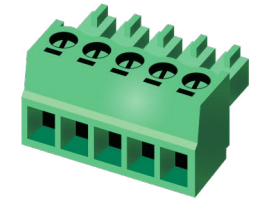

Analog audio connector and plug pin assignments

Compatible Plug Type

Phoenix® Combicon series (3.5mm pitch, 5-pole), type: MC 1.5/5-ST-3.5.

4.2.4. Secure Control LAN, Utility AV LAN, Configurable Ethernet Port

■ INFO: The connector type and the applied cable is the same for the Dante® audio output.

The switcher contains an RJ45 connector for 100Mbit Ethernet/LAN connection for local control functions.

The Ethernet ports can be connected to a LAN hub, switch or router by a CATx cable. Even though both cable types (straight or cross) are supported and handled by the device, the pin assignment below is recommended.

Wiring of LAN Cables

Lightware recommends the termination of LAN cables on the basis of TIA/EIA T 568 A or TIA/EIA T 568 B standards.

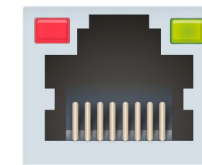

Pin	TIA/EIA T568A	TIA/EIA T568B
1	white/green	white/orange
2	green	orange
3	white/orange	white/green
4	blue	blue
5	white/blue	white/blue
6	orange	green
7	white/brown	white/brown
8	brown	brown

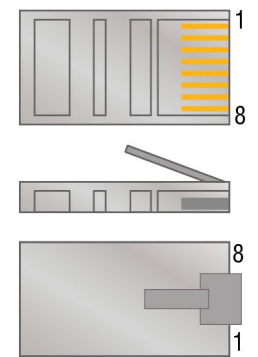

4.2.5. OCS Connector

DIFFERENCE: The DCX-2x1-HC10 switcher does not have an OCS connector.

The switcher is supplied with a 3.81mm 3-pole 90° Reversed Gender Plug Phoenix® connector, which is used for connecting an occupancy sensor. The first pin is a 24V logic input. The default state is high. Different type of sensors exist: some send high level, some send low level to this input when the room is occupied. Active-high or active-low logic can be configured for this port in LDC to support them. The second pin has a constant 24V output voltage, and the third one is the ground.



Pin nr.	Signal
1	24V logic input
2	24V
3	Ground

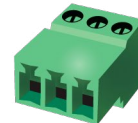

OCS connector pin assignments

Voltage ranges for 1st pin are the following:

	Input voltage [V]
Logic low level	0 - 0.8
Logic high level	2V- 24V

OCS Output Voltage Level: 24V (50mA).

Pull-up resistor is integrated on the input. Works automatically with open-drain type sensors. Requires an external 1kR pull-down resistor between input and ground pins when used with active-high type sensors.

In case of applying Leviton OCS (<https://www.leviton.com/en/products/osc10-m0w>), supplying a 1 kOhm external resistor between the 1st and the 3rd pins is necessary – see the example in the [OCS Sensor](#) section.

DIFFERENCE: In case of the H(C)40 models, the external resistor is not necessary.

Compatible Plug Type

WR-TBL series (3.81mm 3-pole 90° Reversed Gender Plug Phoenix), type: WR-TBL Series 3483 - 3.81 mm.

ATTENTION! The occupancy sensor connector and the GPIO port are not compatible with each other due to voltage level difference, please do not connect them directly.

4.2.6. GPIO - General Purpose Input/Output Ports

DIFFERENCE: The DCX-2x1-HC10 switcher does not have a GPIO connector.

The switcher is supplied with an 8-pole Phoenix® connector with six GPIO pins that operate at TTL digital signal levels, and can be set to high or low level (Push-Pull). The direction of the pins can be input or output (adjustable). Voltage ranges for GPIO inputs are the following:

	Input voltage [V]	Output voltage [V]	Max. output current [mA]
Logical low level	0 - 0.8	0 - 0.5V	30
Logical high level	2 - 5	4.5 - 5V	18

The maximum total current for the six GPIO pins is 180 mA.



Pin nr.	Signal
1	Configurable
2	
3	
4	
5	5V
6	
7	Ground
8	

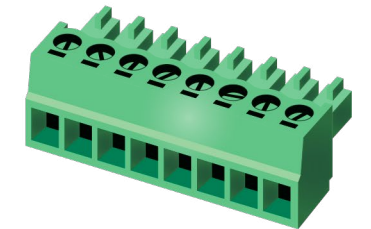

GPIO connector and plug pin assignments

INFO: The recommended cable for the connectors is the AWG24 (0.2 mm² diameter) or the generally used 'alarm cable' with 4x0.22 mm² wires.

Compatible plug type

Phoenix® Combicon series (3.5mm pitch 8-pole), type: MC 1.5/8-ST-3.5.

ATTENTION! The occupancy sensor connector and the GPIO port are not compatible with each other because of the voltage level difference, please do not connect them directly.

4.2.7. RS-232 Connector

DIFFERENCE: The DCX-2x1-HC10 switcher does not have an RS-232 connector. The switcher contains a 3-pole Phoenix® connector, which is used for RS-232 serial connection.



Pin nr.	Signal
1	Ground
2	TX data
3	RX data

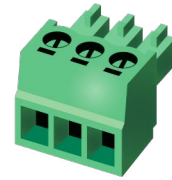

RS-232 connector pin assignments

RS-232 Output Voltage Levels

- Logic low level: 3V .. 15V
- Logic high level: -15V .. -3V

Compatible Plug Type

Phoenix® Combicon series (3.5mm pitch, 3-pole), type: MC 1.5/3-ST-3.5. You can find more information about RS-232 in the [Serial Interface](#) section.

4.3. Powering Options

INFO: The external power supply is not isolated, 230V side is galvanically connected to the 0 output pole.

Powering Locally

The UCX devices are built with 2-pole Phoenix connector for DC power connection.



Pin nr.	Signal
1	-
2	+



Remote Powering via USB-C Ports

The UCX and DCX series devices are designed to provide power delivery for the connected device over the USB-C connectors.

ATTENTION! The P4 USB-C connector of the UCX-4x2-HC40, UCX-4x2-HC40D, UCX-4x3-HC40 and UCX-4x3-HC40-BD switcher and the USB-C port of the UCX-2x2-H40 model is not capable for power delivery.

The following operation modes are available:

- Charge one device with up to 100W. Supported power profiles: 5V/3A, 9V/3A, 15V/3A, 20V/3A 20V/5A.
- Charge one device on the chosen port with up to 60W. Supported power profiles: 5V/3A, 9V/3A, 15V/3A, 20V/3A

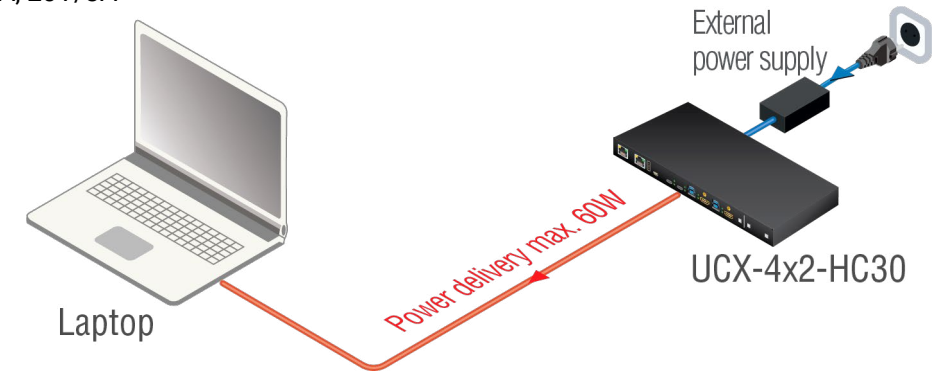

- Charge both devices with 30W. Supported power profiles: 5V/3A, 9V/3A, 15V/2A, 20V/1,5A

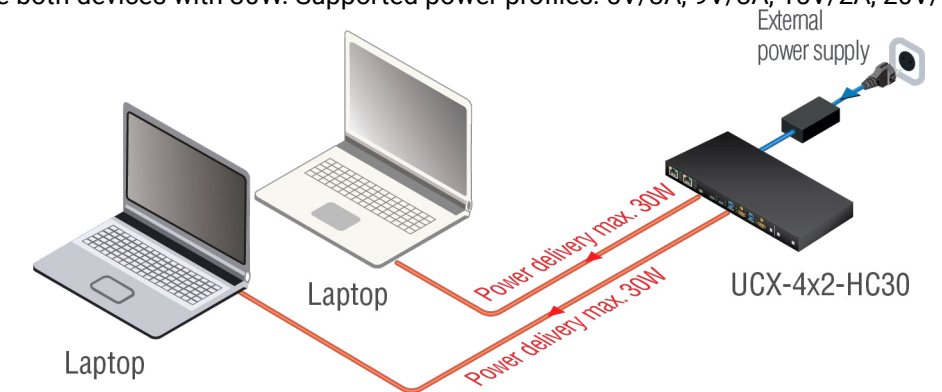

ATTENTION! 2x60W power delivery is available for UCX-4x2-HC30 and UCX-4x2-HC30D from HW v2.4 and FW v1.4.0.

DIFFERENCE: From HW v5.0 and FW v2.4.0, 100W charging over one USB-C port is also available. It is important to note that only the first device connected is qualified for receiving 100W, even if multiple devices are connected, and all remaining charging capacity will be routed to the second connected device. Removing the device will **not** allocate charging potential to other connected devices.

WARNING! Always use the supplied power supply! Use of any other power supplies may lead to damage! Warranty void if damage occurs due to using a different power source.

INFO: Selecting the appropriate power profile happens automatically, no manual intervention required.

Remote Powering via USB-A Ports (D1-D4)

5V output power capability can be turned on and off for all ports. All ports are able to supply 1000mA.

4.4. Power Delivery over Type-C

With Power delivery, these issues were solved:

- Allows negotiation of **up to 100 W** of power delivery to supply or charge equipment connected to a USB-C port.
- Power direction is **not fixed**.
- Intelligent and flexible system-level **management of power** (negotiation); the two connected partners exchange real-time PD protocol messages through the CC (control channel) lines.

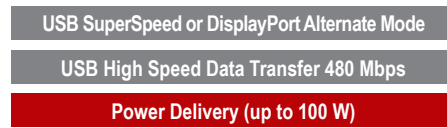

USB PD supersedes all previous technologies and does not incorporate them. It can achieve any of the previous levels, but does so with its own methods.

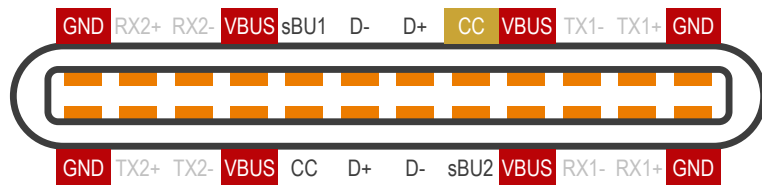

Power Pins of USB-C Connector

- The VBUS and GND pins are power and the return paths for the signals
- The CC channel is used for power negotiation
- The other CC pin can be used for VCONN powering

USB Chargers

USB-C PD covers a range of different power levels, with different amperage and voltage combinations that a charger can deliver, depending on what the device asks for and the cable negotiates. These values are defined by PDO (Power Data Objects).

According to the specification, 12V is not a mandatory Voltage level. The reason for support in case of certain chargers is that the 12V value was on the mandatory list of a former specification.

4.4.1. Power Data Objects (USB-C)

Power Data Object (PDO) defines a power capability:

- Nominal voltage and maximum current
- A Source must have at least one PDO
- The Sink chooses one of the Source's PDOs via CC communication

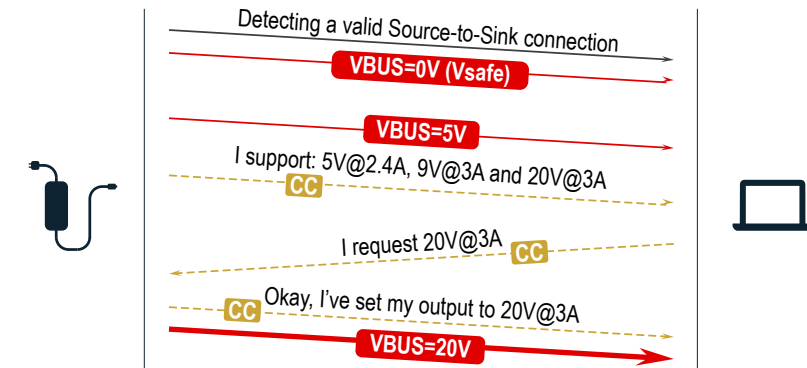
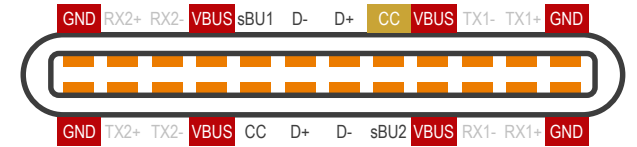

Powering Handshake

Dual-Role Power

With USB-C, the connector is the same on all products. Laptops, certain tablets and smartphones can be both a charger and a charged device (not simultaneously). Source/Sink defines the power role the port is currently operating in.

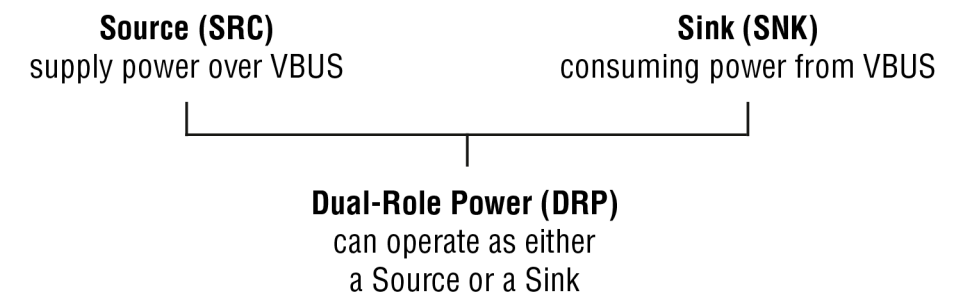

	Source-only	Sink-only	Dual-Role Power
Source-only	Non-functional	Functional	DRP = Sink
Sink-only	Functional	Non-functional	DRP = Source
Dual-Role Power	DRP = Sink	DRP = Source	DRPs negotiate

4.5. USB-C Cable Recommendation

Please find the recommendations for the applied cables below:

- Use Full-featured USB Type-C cables made by reliable brands.
- USB2.0 cables do not have the Superspeed channels, neither DP video, nor USB3 transmission works with them.
- Type-C cables certified for USB 3.x Gen1-Gen2 (5Gbps or 10Gbps) and Displayport Alternate mode HBR2-HBR3 (5.4Gbps or 8.1Gbps) applications are recommended.
- Thunderbolt cables are not backwards compatible with USB3.x or Displayport unless the manufacturer explicitly states so.
- Passive, 20Gbps Thunderbolt 3 cables, which are also specified for USB3.x are a good, but more expensive choice.
- 5A charging capability is not required. All USB Type-C cables should support at least 3A (up to 60W) charging.

4.6. Connecting Steps

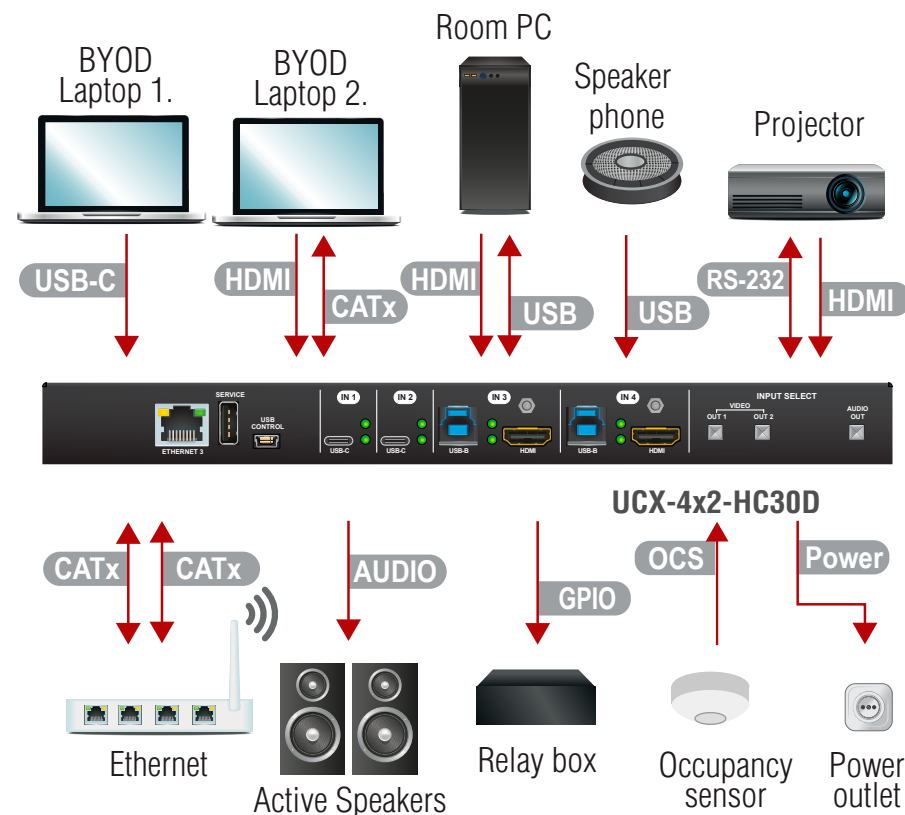

- USB-C** Connect a USB-C source (e.g. BYOD laptop) to the USB-C input port. The applied cable shall be certified for USB 3.1 Gen1 (5Gbps) and Displayport Alternate mode HBR2 (4x5.4Gbps) applications. UCX-2x2-H30 model has no USB-C port.
- HDMI** Connect an HDMI source (e.g. BYOD laptop or room PC) to the HDMI input port.
- CATx** Connect a device (e.g. BYOD laptop) to the Utility Ethernet port to access the internet or local network.
- USB** **USB Type-A:** Optionally connect the USB device (e.g. Speaker phone). **USB Type-B:** Optionally connect the USB host (e.g. PC).
- HDMI** Connect an HDMI sink (e.g projector) to the HDMI output port.
- RS-232** Optionally for RS-232 extension: connect a controller/controlled device (e.g. projector) to the RS-232 port.
- CATx** Optionally connect the Secure Control Ethernet port to a Local Network Switch to provide Ethernet connection for device configuration and BYOD internet access.
- Audio** Optionally connect an audio device (e.g. active speakers) to the analog audio output port by an audio cable.
- GPIO** Optionally connect a device (e.g. a relay) to the GPIO port.
- OCS** Optionally connect an occupancy sensor to the OCS port.
- Power** Connect the external power supply to the AC power socket and the switcher unit. Powering the device is recommended as the final step.

ATTENTION! The USB-C ports of Taurus are developed to connect native USB-C sources. HDMI-USB-C or DP-USB-C adapters are not supported and not recommended to apply.

INFO: Connecting USB-B and HDMI ports to the same PC or laptop is recommended in case of IN3 and IN4 inputs.

5

Device Concept

The following chapter describes the features of the device with a few real-life examples.

- ▶ UNIVERSAL SWITCHER CONCEPT
- ▶ USB INTERFACE
- ▶ VIDEO INTERFACE
- ▶ THE AUTOSELECT FEATURE
- ▶ AUDIO INTERFACE
- ▶ ETHERNET INTERFACE
- ▶ LIGHTWARE ADVANCED ROOM AUTOMATION (LARA)
- ▶ BASIC NETWORK SECURITY
- ▶ 802.1x AUTHENTICATION
- ▶ ADVANCED ETHERNET SECURITY
- ▶ LIGHTWARE CRYPTO CORE
- ▶ WEBSOCKET SERVICE (WS, WSS)
- ▶ BULK DEVICE MANAGEMENT
- ▶ SERIAL INTERFACE
- ▶ GPIO INTERFACE
- ▶ OCS INTERFACE
- ▶ FURTHER BUILT-IN FEATURES

5.1. Universal Switcher Concept

UCX-4x2-HC30

Lightware's universal switcher exploits the USB-C connectivity for a simplified transmission of 4K video, audio, control signals and power providing meeting participants with easy host switching, utilizing data speeds of up to 5 Gbps under the USB 3.1 Gen1 providing video supporting up to 4k@60Hz at 4:4:4 video resolution.

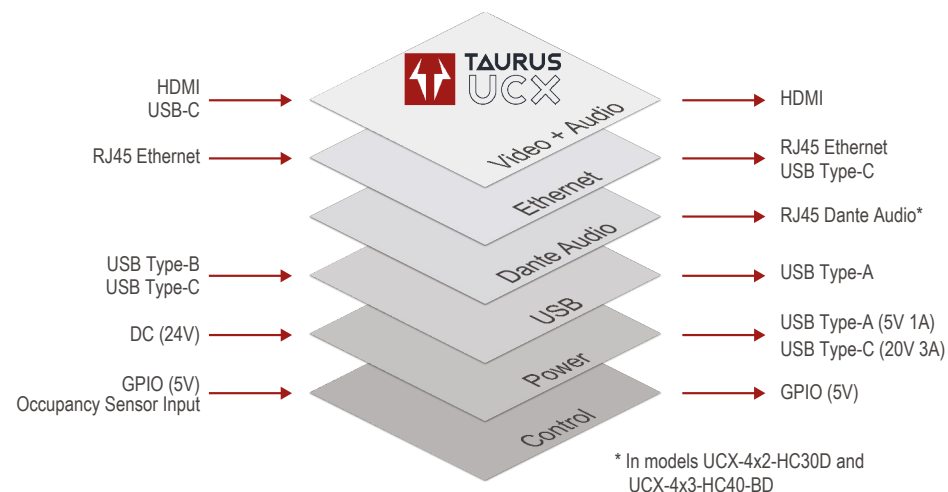

5.2. USB Interface

5.2.1. USB-C Interface

DIFFERENCE: UCX-2x2-H30 model has no USB-C port.

Summary of USB-C Ports

	UCX-2x1-HC30	UCX-2x1-HC40	UCX-2x2-H30	UCX-2x2-H40	UCX-4x2-HC30, (D)	UCX-4x2-HC40, (D)	UCX-4x3-HC40-BD	UCX-4x3-HC40	DCX-2x1-HC10	DCX-3x1-HC20
USB-C 3.1 Gen1 (5 Gbps) 	1x	1x	-	1x	2x	3x	3x	3x	1x	1x

DIFFERENCE: The USB-C connector of the DCX-2x1-HC10 and DCX-3x1-HC20 models does not transmit USB data and Ethernet.

DIFFERENCE: In UCX-4x2-HC40, UCX-4x3-HC40, UCX-4x2-HC40D and UCX-4x3-HC40-BD the P4 USB-C port does not transmit video, Ethernet or remote power, only USB data. The same applies to the USB-C port of the UCX-2x2-H40 model.

INFO: The -LCC models have the same values as non-LCC models.

USB-C Pinout and Data Channels

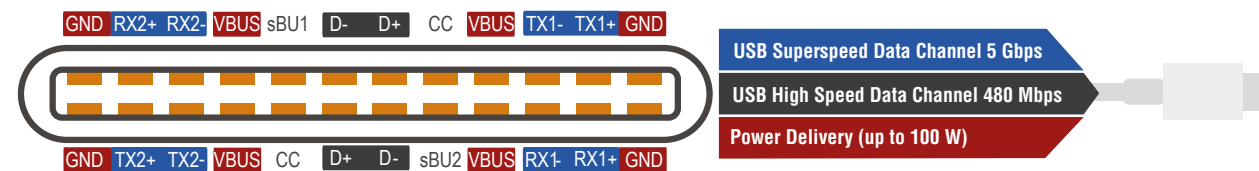

The USB-C interface consists of three main layers:



USB Data

- Taurus UCX series supports USB 3.1 Gen1 (max. 5 Gbps data speed) on their USB-C ports. This data is transmitted over the USB Superspeed data channels.
- USB 2.0 data (480 Mbps) is transferred over the High-speed data channels. The built-in USB-Ethernet bridge provides Ethernet connection over the USB-C connector. This function uses the High-speed channels. For more details, see the [USB Port Diagram \(UCX-4x2-HC30D\)](#) and the [Ethernet Interface](#) section.

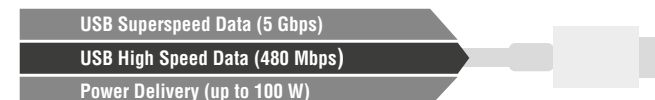
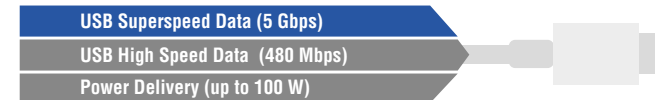

INFO: USB.2.x and 3.x data transfer happens on two independent layers simultaneously.



DisplayPort Alternate Mode (Video + Embedded Audio)

- DisplayPort Alternate Mode:** Alternate mode is designed for carrying uncompressed, native Displayport video as non-USB data (All Superspeed Data lanes deliver video signals, it reserves the whole bandwidth of the SS Lines).
- DisplayPort Alternate mode and USB 3.1 data shared: AV signals and USB 3.1 data are transmitted at the same time, sharing the bandwidth (2 SuperSpeed lines for video + 2 SuperSpeed lines for USB 3.1).

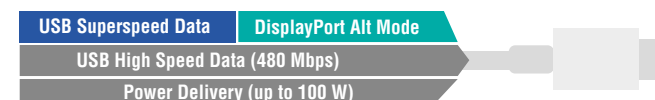
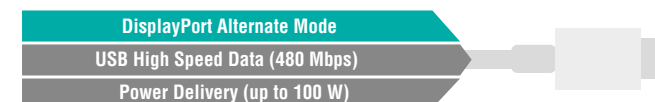

Power Delivery

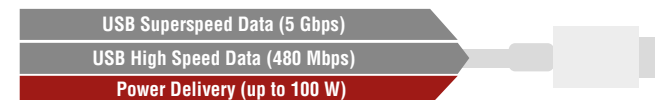

- Going outward to power/charge external devices.



5.2.2. USB Data - USB 3.1 Gen1 Interface

DIFFERENCE: UCX-2x2-H30 model has no USB-C port.

Summary of USB 3.1 Gen1 ports

	Upstream ports (UFP)		Downstream ports (DFP)
	USB-C 3.1 Gen1 (5 Gbps)	USB-B 3.1 Gen1 (5 Gbps)	USB-A 3.1 Gen1 (5 Gbps)
			
UCX-2x1-HC30	1x	1x	4x
UCX-2x1-HC40	1x	1x	4x
UCX-2x2-H30	-	2x	4x
UCX-2x2-H40	1x	1x	4x
UCX-4x2-HC30	2x	2x	4x
UCX-4x2-HC40	3x	1x	4x
UCX-4x2-HC30D	2x	2x	4x
UCX-4x2-HC40D	3x	1x	4x
UCX-4x3-HC40-BD	3x	1x	4x
UCX-4x3-HC40	2x	1x	4x
DCX-2x1-HC10	-	-	-
DCX-3x1-HC20	-	-	-

INFO: The -LCC models have the same values as non-LCC models.

USB Port Diagram (UCX-4x2-HC30D)

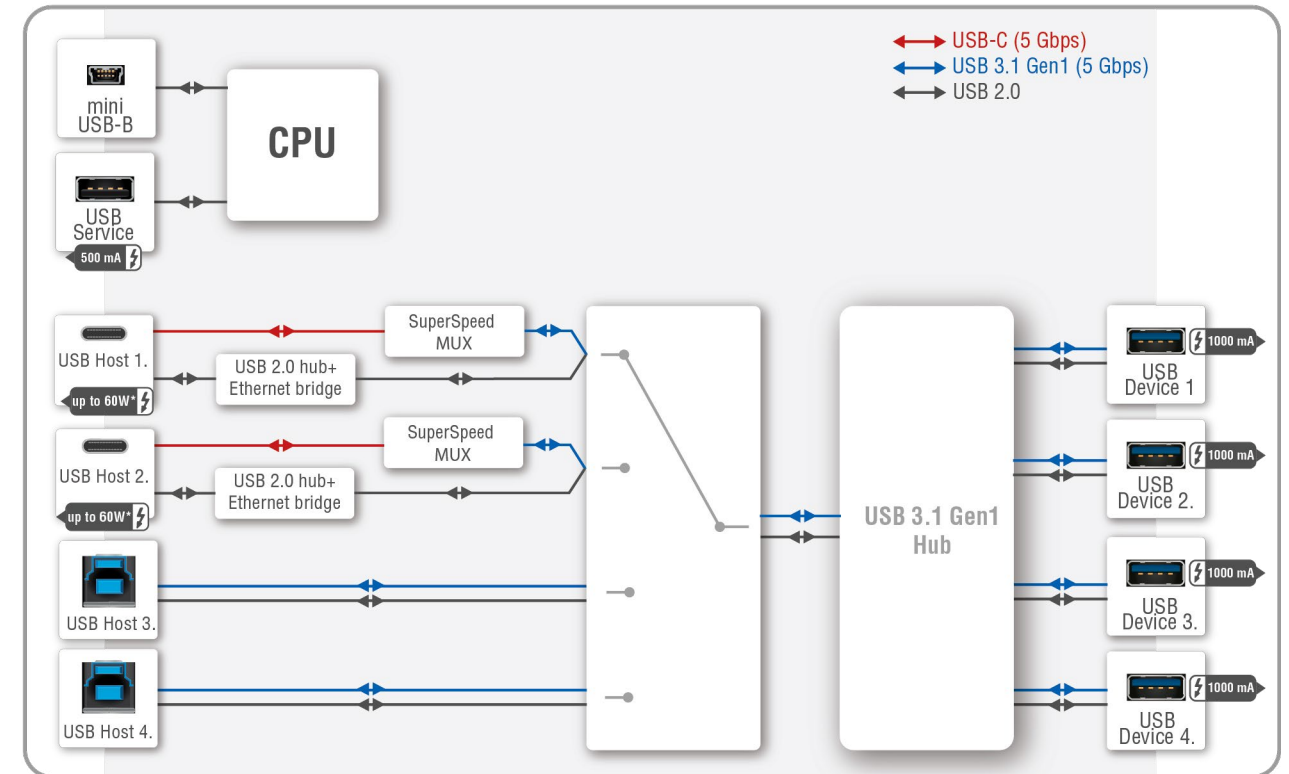

*For more details about the power delivery of the USB-C port, see the [Powering Options](#) section.

INFO: The Taurus UCX series devices generally present 1 tier in the USB topology (a HUB). An exception is the USB2 layer on Type-C ports, which presents two tiers (two HUBs).

The USB 3.1 standard is backwards compatible. This means the High-speed channels (USB 2.0 lines) are used if the connected device or cable capability is only USB 2.0.

USB-A, USB-B and USB-C connectors also have high-speed data lines besides Superspeed.

The built-in USB-Ethernet bridge provides Ethernet for the USB-C connection. It is still available while the USB 3.1 Gen1 data channels are reserved for video or USB data transmission. For more details, see the [Ethernet Port Diagram](#).

INFO: The DCX-2x1-HC10 model does not have a USB-Ethernet bridge, thus does not provide Ethernet over the USB-C port.

INFO: USB.2.x and 3.x data transfer happens on two independent layers simultaneously.

USB Features

DisplayPort Alternate Mode

This function is available only for USB type C connectors. See more details in the [DisplayPort Alternate Mode](#) section.

DIFFERENCE: The DCX-2x1-HC10 model only has a forced **4 Lane Video** setting.

Host detection

One host is available at once. Taurus UCX series devices give a feedback about the connected hosts.

In case of USB Type-B ports: When the 5V is detected on USB Vbus, the **Connected** property becomes true.

In case of USB Type-C ports: USB Type-C introduced the port Power Roles: Sink port, Source port and Dual Role Power port. Supplying VBUS is not the privilege of the USB Host anymore.

Detecting the presence of a BYOD device on Type-C ports is done using the Power Delivery protocol over the Communication Channel.

Sending 5V Power to the Device

This function allows sending 5V power to the device (USB peripheral). Most USB devices can be powered by this 5V, so disabling and enabling this property is equal to unplugging the USB connector and plugging it back in.

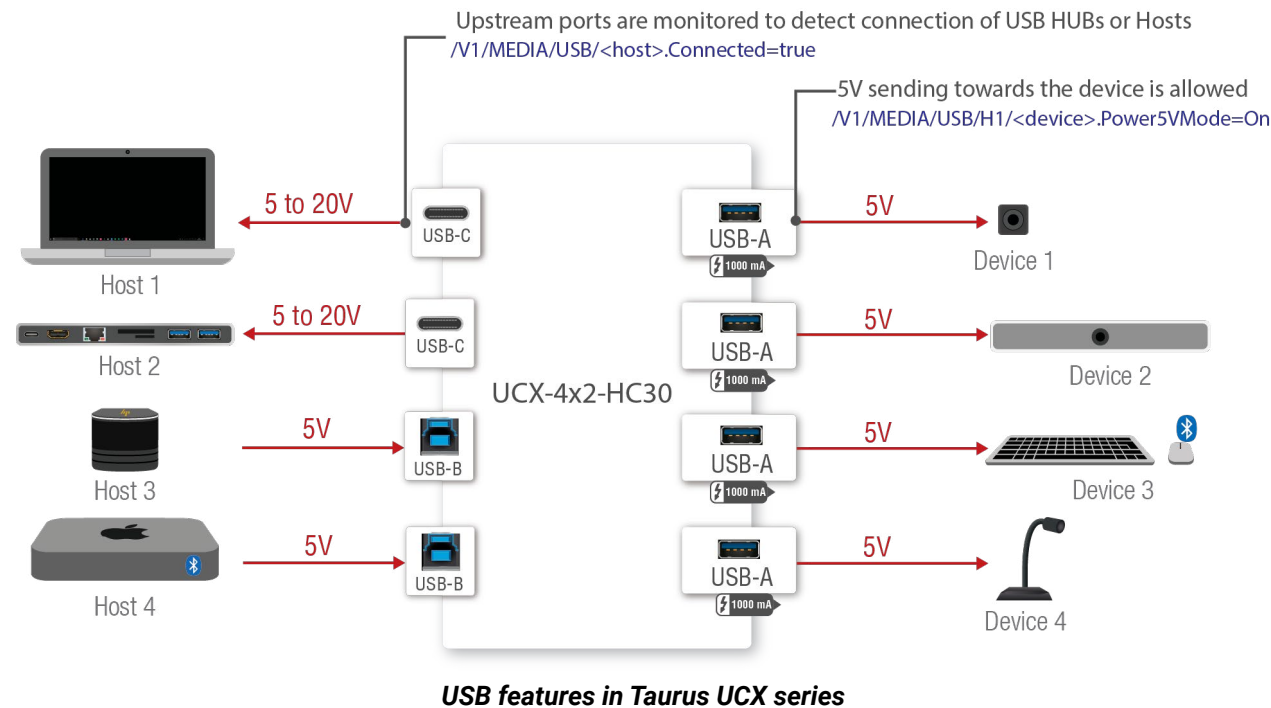

Application of USB - Example

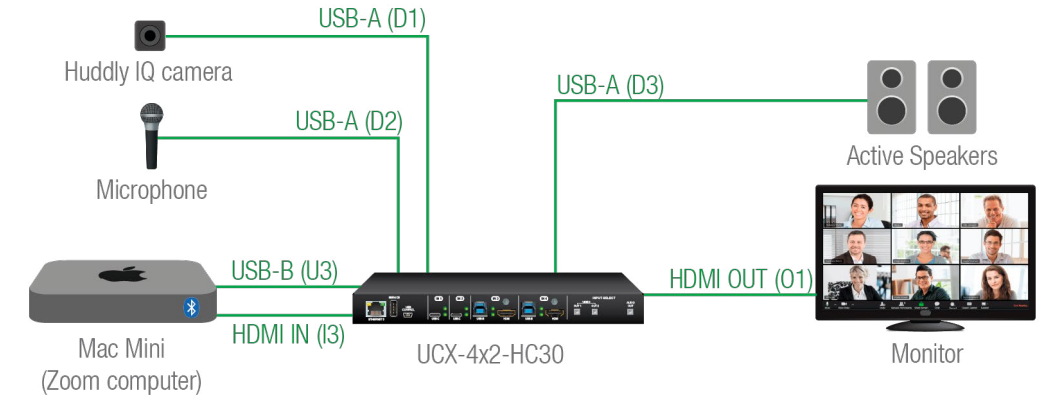

The Concept

The Webcam and USB microphone (D2) are connected to the Mac Mini computer(U3) through a USB HUB (Taurus UCX). Zoom running on the computer sends video and embedded audio signal to the Taurus HDMI input (I3).



The switcher forwards analog audio to the active speakers and digital video to the HDMI display.

Settings

- Step 1.** In the Crosspoint menu, USB tab, switch the Mac Mini (U3) to the USB hub(H1).
- Step 2.** Pay attention to the connected USB devices (D1 and D2) and turn on the **Power 5V Mode**.
- Step 3.** The video crosspoint is switched to I3-O1.

5.2.3. USB Service Ports - USB 2.0 Interface

Summary of USB 2.0 ports

	Service ports	
	USB-A USB 2.0 (480 Mbps)	mini USB- B USB 2.0 (480 Mbps)
		
UCX-2x1-HC30	✓	✓
UCX-2x1-HC40	✓	✓
UCX-2x2-H30	✓	✓
UCX-2x2-H40	✓	✓
UCX-4x2-HC30	✓	✓
UCX-4x2-HC40	✓	✓
UCX-4x2-HC30D	✓	✓
UCX-4x2-HC40D	✓	✓
UCX-4x3-HC40-BD	✓	✓
UCX-4x3-HC40	✓	✓
DCX-2x1-HC10	-	✓
DCX-3x1-HC20	✓	✓

The **SERVICE**-labelled USB-A connector is designed for service function. The Mini B-type connector is reserved for future LW3 control. Both features will be added by a future firmware update.





INFO: The -LCC models have the same values as non-LCC models.

5.3. Video Interface

ATTENTION! The USB-C ports of Taurus are developed to connect native USB-C sources. HDMI-USB-C or DP-USB-C adapters are not supported and not recommended to apply.

Summary of Video Ports

#welcomescreen

	 Welcome screen option	Video Inputs		Video Outputs
		 Displayport Alternate mode HBR2 (4x5.4Gbps)	 HDMI 2.0 (18 Gbps)	 HDMI 2.0 (18 Gbps)
UCX-2x2-H30	✓	-	2x	2x
UCX-2x2-H40	✓	-	2x	2x
UCX-2x1-HC30	✓	1x	1x	1x
UCX-2x1-HC40	✓	1x	1x	1x
UCX-4x2-HC30	✓	2x	2x	2x
UCX-4x2-HC40	✓	2x	2x	2x
UCX-4x2-HC30D	✓	2x	2x	2x
UCX-4x2-HC40D	✓	2x	2x	2x
UCX-4x3-HC40-BD	✓	2x	2x	3x
UCX-4x3-HC40	✓	2x	2x	3x
DCX-2x1-HC10	-	1x	1x	1x
DCX-3x1-HC20	-	1x	2x	1x

INFO: The -LCC models have the same values as non-LCC models.

5.3.1. Welcome Screen

DEFINITION: The Welcome screen is an internal source, which can be customized by uploading an image file, jpg, or bmp. Besides this, custom text can be set to display on the output with or without the image.

Rules

- Welcome screen is an option and appears as an **additional input**.
- The image and the text can be **displayed separately or together** as well.
- If the image option is not enabled, a **light grey screen** is displayed.
- One image can be stored in the device. If a new image is uploaded, the existing one **will be overwritten**.
- The max. image size is 4MB, preferred resolution is 1280x720.
- The text length can be max. **63 characters** and the following characters are allowed: letters (a-z, A-Z), space, hyphen (-), underscore (_), numbers (0-9) and dot (.). The text color is **black**.
- If no image is uploaded, the factory default image (**Lightware logo**) can be displayed.



The Default Welcome Screen

Limitations

- If the I1 input port is switched to an output, the **Welcome screen is not available**.
- If the Welcome screen is switched to an output:
 - **I1 input port is not available** and I1 audio cannot be de-embedded to the analog audio output port.
 - I1 does not send hotplug signal and the **signal parameters of the I1 port are not measured**.
- If the audio of the I1 port is switched to the analog audio output and the Welcome screen is switched to the output, **the audio signal is lost**, however, the audio crosspoint is not changed.

5.3.2. Video Port Diagrams

UCX-2x1-HC30, UCX-2x1-HC40, DCX-2x1-HC10

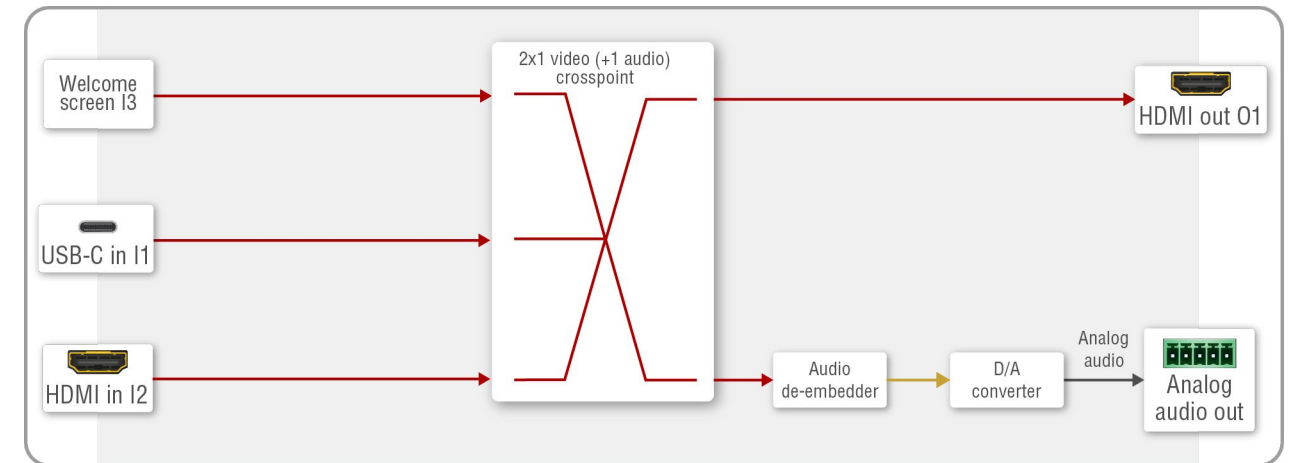

DIFFERENCE: The DCX-2x1-HC10 model has no Welcome Screen.

UCX-2x2-H30, UCX-2x2-H40

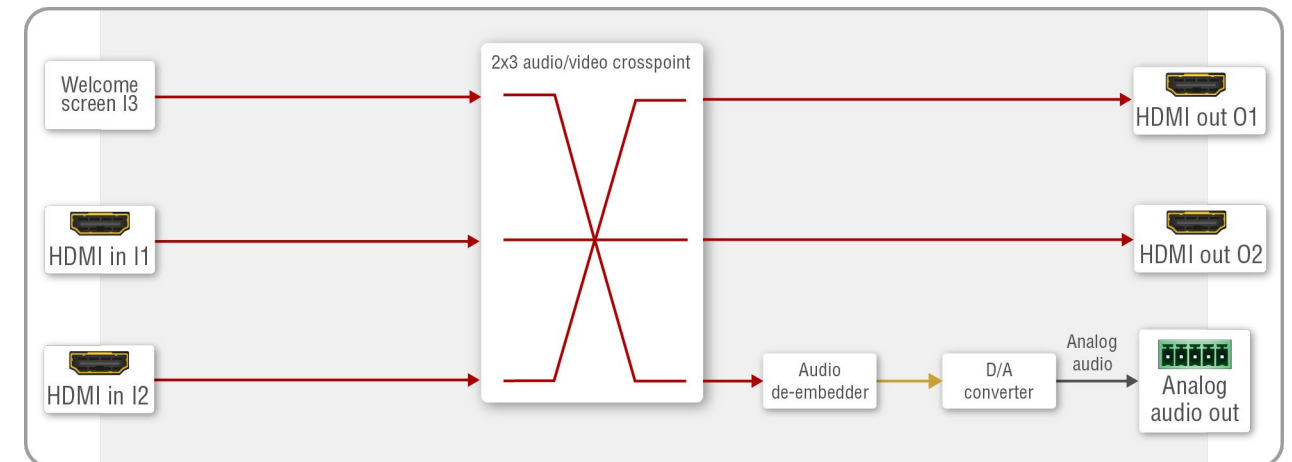

UCX-3x1-HC20

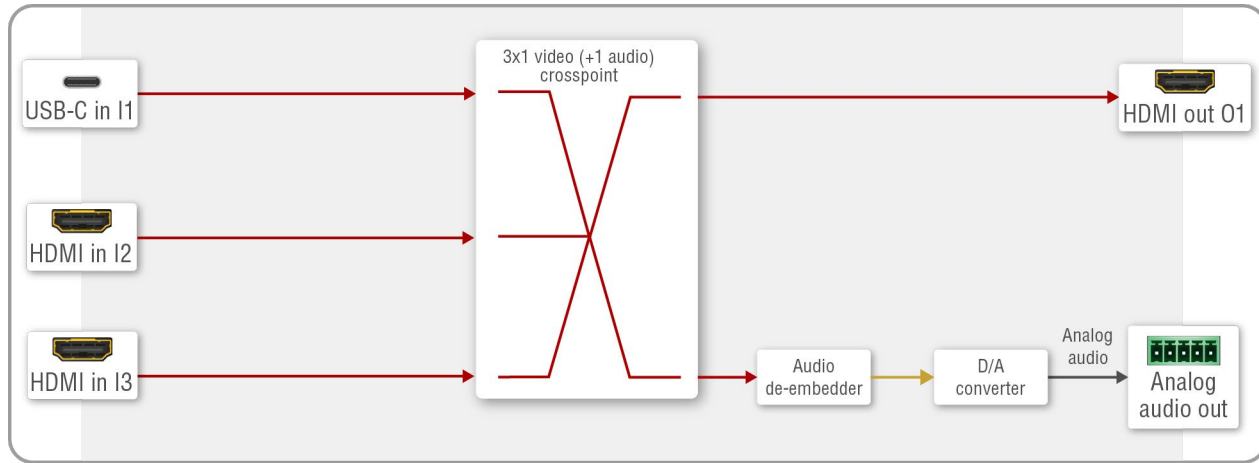

UCX-4x3-HC40, UCX-4x3-HC40-BD

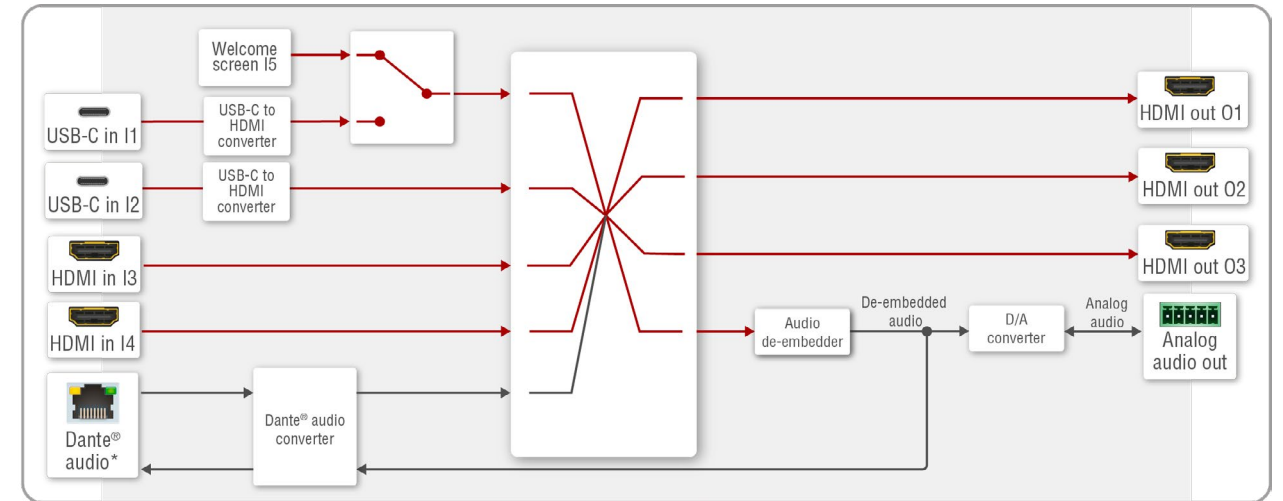

UCX-4x2-HC30, UCX-4x2-HC40, UCX-4x2-HC30D and UCX-4x2-HC40D

The working method of the models is the same, the difference is just the number of the video ports; for more information, see the [Model Comparison](#) section.

INFO: The source that is connected to the USB-C port sends DisplayPort video signal. This signal is converted to HDMI by the video IC internally.

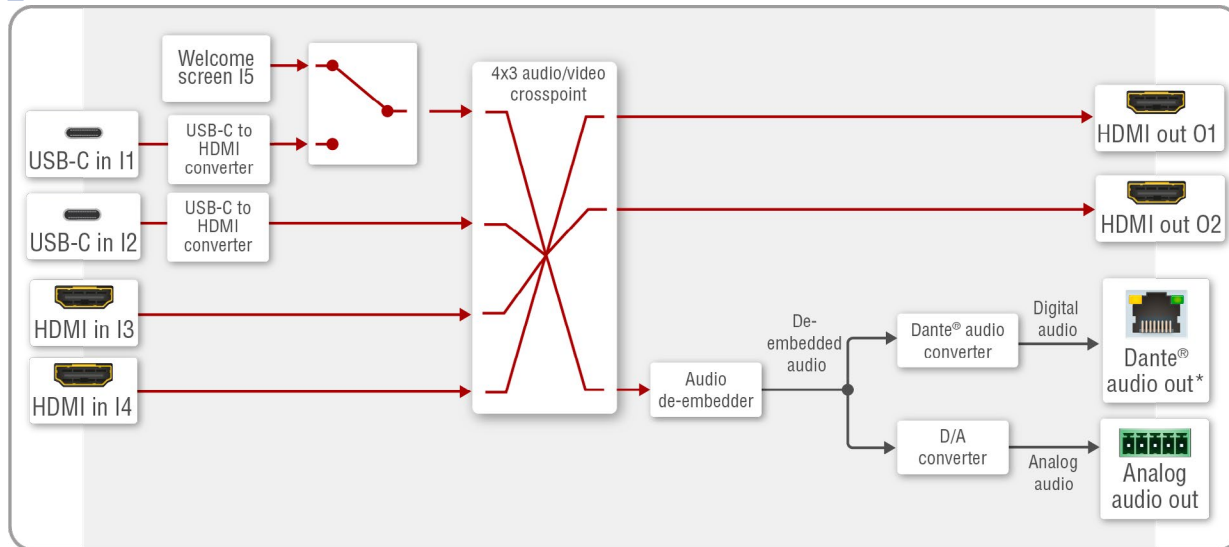

DIFFERENCE: The UCX-4x2-HC30D and UCX-4x2-HC40D models have Dante® Audio Output.

DIFFERENCE: The UCX-4x3-HC30-BD model has Dante® Audio port.

5.3.3. DisplayPort Alternate Mode

USB-C sources send Displayport signal for video transmission.

Displayport Alternate mode allows using the USB-C cable instead of DisplayPort cable for DP video signals. The standard uses the Superspeed data transfer channels for carrying the video stream.

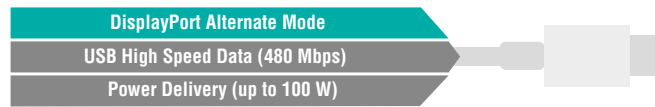

ATTENTION! The bandwidth of the video is based on the capacity of the source and the sink. USB3.1 Generation (Gen1=5Gbps, Gen2=10Gbps) is not related to DP bitrate (HBR1=4x2.7Gbps, HBR2=4x5.4Gbps)

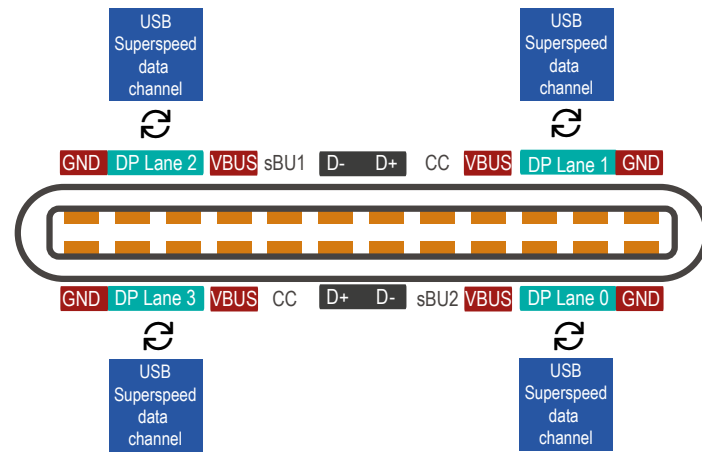

USB-C pinout in DP Alt mode

In Alt Mode, 2 or all 4 of the USB-C Superspeed data channels can be configured as DisplayPort lanes. A full-bandwidth DisplayPort connection is always defined as 4 lanes.

The table below shows the correlation of the video resolution and the assigned lanes:

DisplayPort Video			DisplayPort Alternate Mode			
DisplayPort Standard	Raw bandwidth (1 lane)	Display Resolutions	2-Lane DP		4-Lane DP	
			BW	Display Resolutions	BW	Display Resolutions
HBR1 (DP 1.0 / 1.1)	2.7 Gbps	1440p@60 Hz	5.4 Gbps	1 × FullHD	10.8 Gbps	1 × 4K@30 Hz
HBR2 (DP 1.2)	5.4 Gbps	4K@60 Hz	10.8 Gbps	1 × 4K@30 Hz	21.6 Gbps	1 × 4K@60 Hz

DIFFERENCE: The DCX-2x1-HC10 model only has a forced 4 Lane Video setting.

5.3.4. DisplayPort Alternate Mode and USB 3.x Mixed

The two different signals (video and USB 3.x) can be transmitted at the same time with shared bandwidth.

DP video reserves 2x Superspeed Channels for the video signal in alternate mode. 2x Superspeed Channels for USB 3.x. This setting can be configured manually via [Software Control Options](#) or via LW3 protocol commands (for more details, see the [LW3 Programmers' Reference](#) section).

5.3.4.1. Thunderbolt Compatibility



Thunderbolt 3 standard uses USB-C connector to transmit data. The standard is compatible backwards, so it is able to fall back to Displayport Alternate mode. In this case, the maximum bandwidth of transmitted video signal is based on the connected sink capability (e.g. HBR2, 5.4Gbps per lane in case of UCX-4x2-HC30 switcher).

5.4. The Autoselect Feature

DIFFERENCE: The autoselect feature for USB layer is available only from FW package v1.1.0b7.

Aside from manually selecting crosspoints, you can choose the Autoselect option in case of video and USB ports.

Video input source can be selected in the following ways:

- using the front panel buttons
- using Lightware Device Controller (LDC)
- sending LW3 protocol command or
- using the Autoselect function.

There are three Autoselect policies as follows:

- Disable autoselect
- First detect
- Last detect
- Follow video (in case of USB and audio ports)

INFO: SignalPresent cannot be sensed on I1 if I5 is displayed due to the mutually exclusive operation of video input I1 and the internal Welcome screen image generator I5. Welcome screen image will disappear and the video crosspoint will be switched to I1 upon connecting a Host computer to I1, regardless of whether the computer sends Displayport image or not.

Individual input settings

This setting defines the priority level of the ports. The priority property is valid both for first detect and last detect operation modes. It overrides the chronological order of the appearance of the active video signal. The highest priority active input is always selected to transmit (1- highest priority, 100- lowest priority).

TIPS AND TRICKS: To use the individual input settings, change the default priority settings from 1 to 5 depending on their importance (e.g. I1 priority:1; I2 priority:2; I3 priority:3; I4 priority:4; I5 priority:5).

ATTENTION! The autoselect function remains active after the manual crosspoint switching. This operation mode works in contrast to the other Lightware matrix switchers or extenders.

Disable autoselect

The crosspoint state change only happens manually.

First detect

The selected input port is kept connected to the output as long as it has an active signal. The crosspoint changes when the signal becomes inactive on the chosen input, or when the video signal appears on a higher priority port.

TIPS AND TRICKS: To uphold the first detect mode, default priority settings (I1 priority:50; I2 priority:50; I3 priority:50; I4 priority:50; I5 priority:100) are appropriate. Lower priority of the I5 port is highly recommended, because this is an internal source with constant video signal, thus this port is always the first one.

Last detect

It is always the last attached input that is selected to transmit. The crosspoint changes when the signal becomes inactive on the chosen input, or when the active video signal appears on a port with the same or higher priority.

TIPS AND TRICKS: To uphold the last detect mode, default priority settings (I1 priority:50; I2 priority:50; I3 priority:50; I4 priority:50; I5 priority:100) are appropriate.

Automatic Input Selection- Example 1.

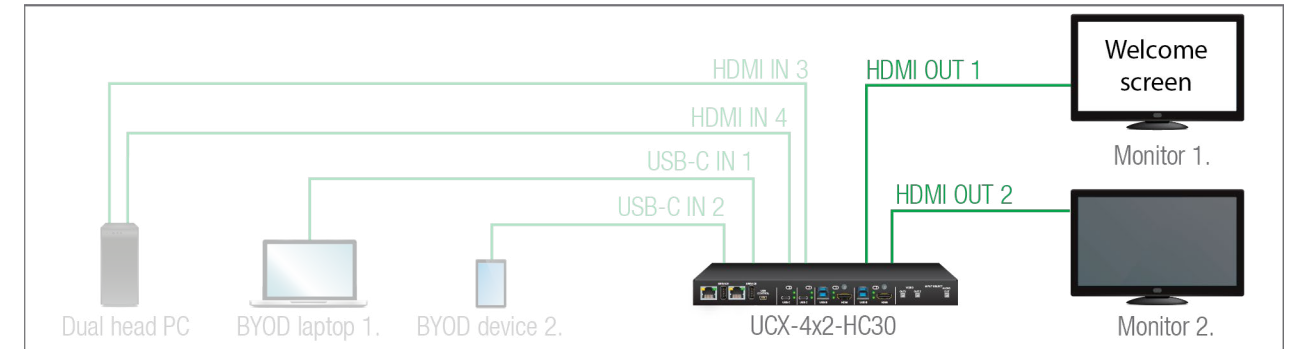

The Welcome screen appears on the Monitor 1. (O1) when no active source is connected.

The video signal of the dual-head PC (I3, I4) can be seen on Monitor 1. and Monitor 2. (O1 and O2) when it is powered on and no BYOD device is connected.

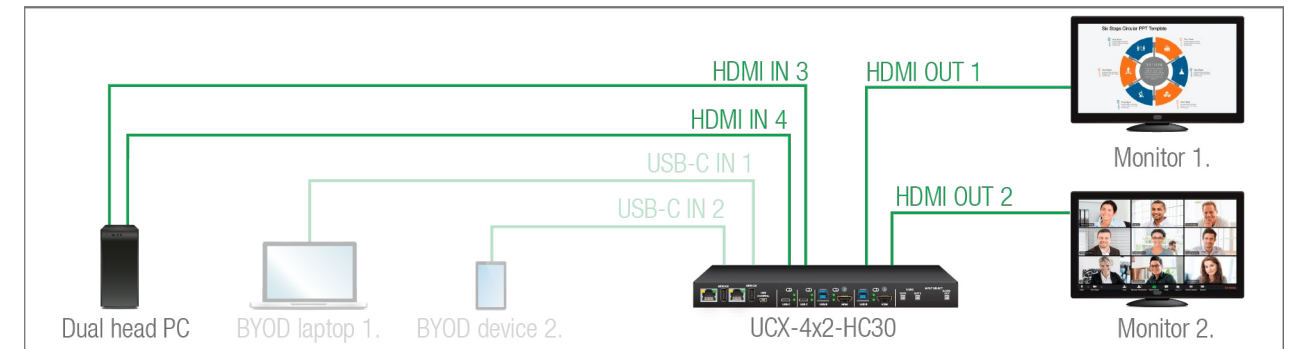

BYOD laptop 1. (I1) is displayed on Monitor 1. (O1) and BYOD device 2. (I2) can be seen on Monitor 2. when they are connected and send active video signal. The individual input settings are the following:

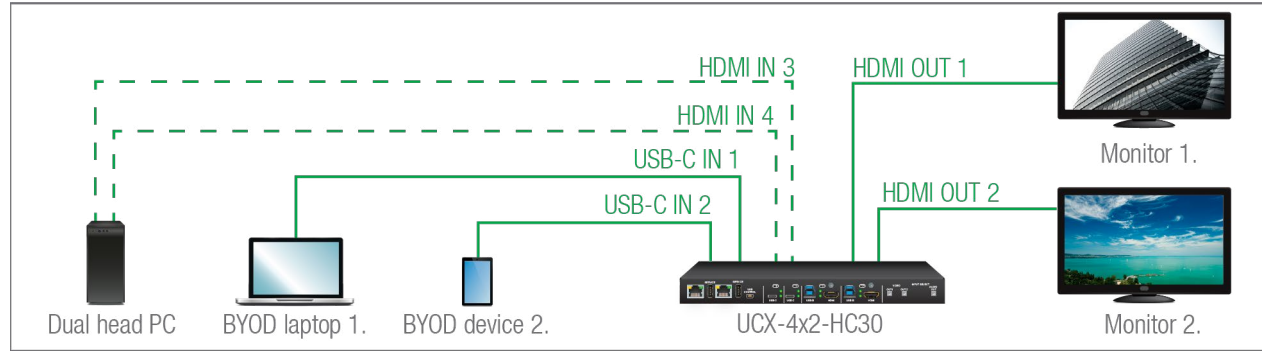

O1: I1 priority:1; I2 priority: disabled; I3 priority:2; I4 priority: disabled; I5 priority:3
 O2: I1 priority: disabled; I2 priority: 1; I3 priority: disabled; I4 priority: 2; I5 priority: disabled

Automatic Input Selection - Example 2.

One of the BYOD laptop is switched to Monitor 1. depending on the operation policy (Last detect/first detect) and the connection order of the BYOD laptops. The USB autoselect mode should be **Follow video**, the USB peripherals (webcam, microphone etc.) are connected to the chosen laptop. The USB Type-C provides Ethernet to the BYOD device, so the conferencing software can run there.

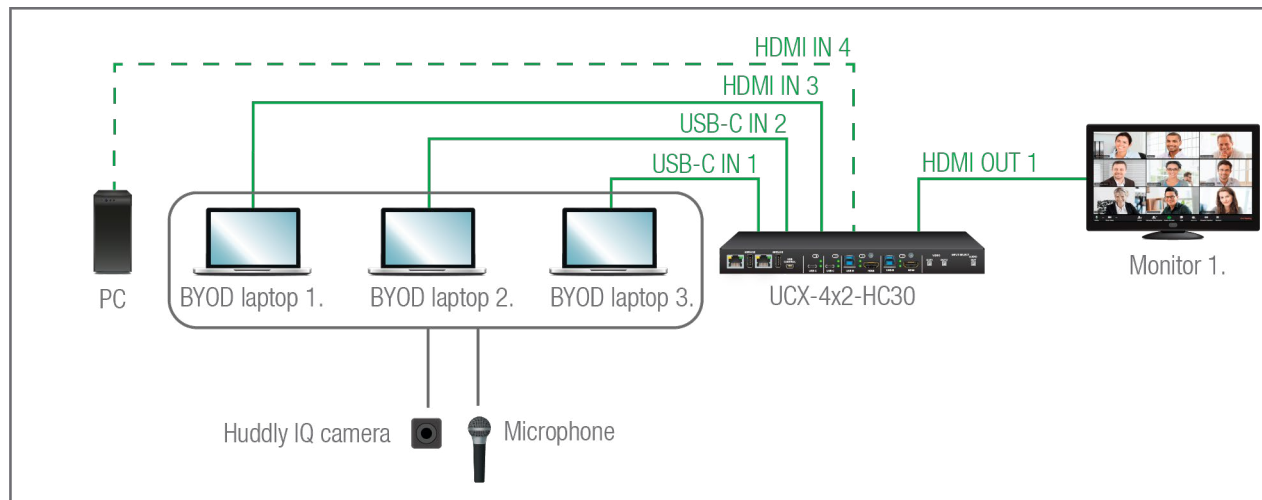

When no active BYOD device is connected and the local PC is powered on, the UCX-4x2-HC30 is switched to I4 and transmits the video to Monitor 1.

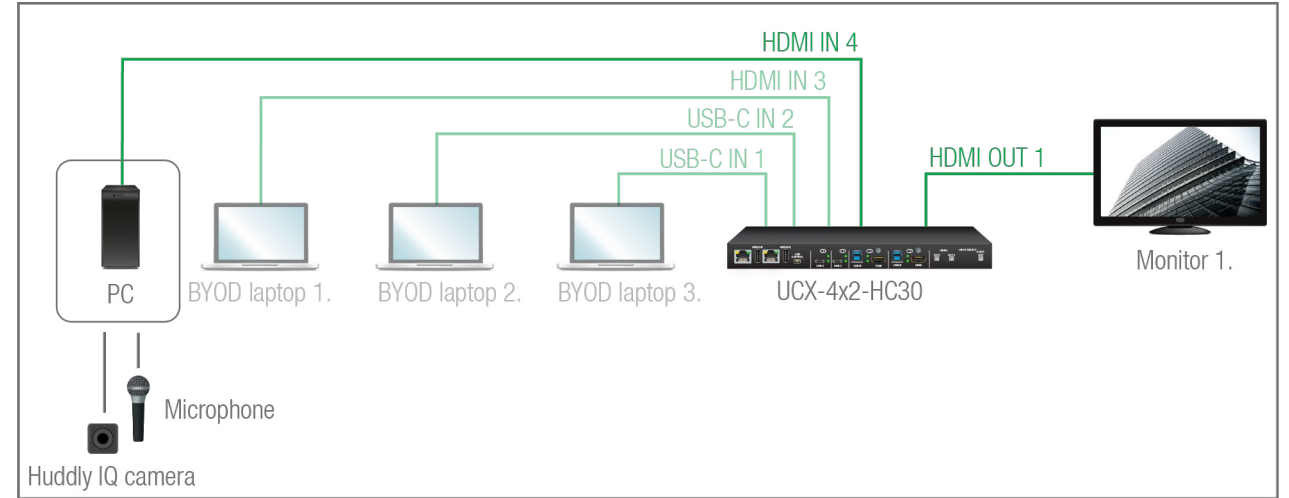

The individual input settings are the following:

O1: I1 priority:1; I2 priority: disabled; I3 priority:2; I4 priority: disabled; I5 priority:3

Automatic Input Selection - Example 3.

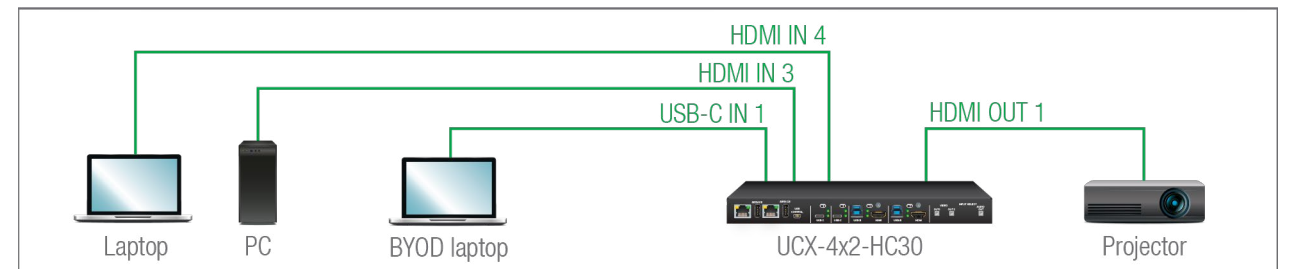

The laptop on HDMI input 4 will be automatically switched to the HDMI output if there is no other source connected to the switcher. If the PC is powered on and has active video signal, the HDMI input 3 will be switched to the HDMI output. If the BYOD Laptop is connected through the USB-C input 1, it will be switched to the HDMI output – independently of the presence of the other video signals.

Set the Autoselect mode to Last detect for HDMI out 1: The priorities are the following (the lowest number means the highest priority):

Source device	Input port	Priority
Laptop	I4 (HDMI in 4)	3
PC	I3 (HDMI in 3)	2
BYOD Laptop	I1 (USB-C in 1)	1

Priorities can be set in Lightware Device Controller software, see the related settings in the [HDMI Video Output](#) section.

Automatic Input Selection - Example 4.

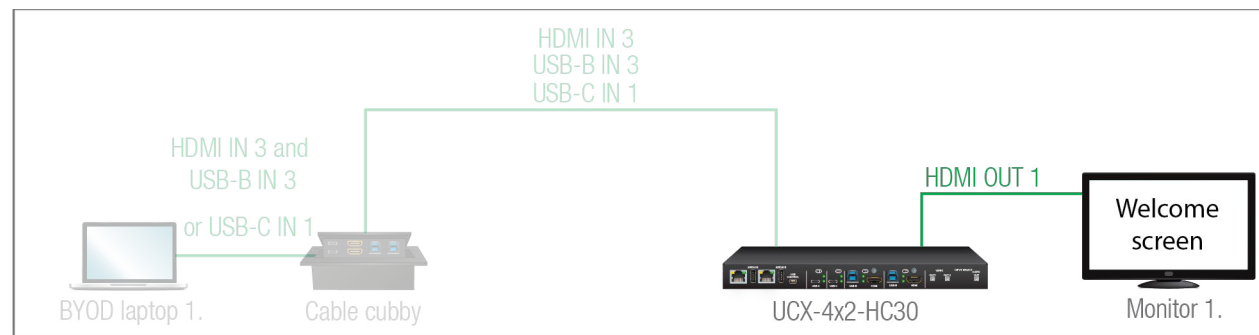

DIFFERENCE: The autoselect for USB layer feature is available only from FW package v1.1.0b7.

The Welcome screen appears on the Monitor 1. (O1) when no active source is connected. A presenter can choose what cable(s) are appropriate for their BYOD. Either a USB Type-C cable alone for both USB and Displayport, or one USB cable (USB-B or USB-C) for data and one HDMI cable for video can be used. The Taurus UCX series device will switch both USB and video layers accordingly. Cable cubby for BYOD #1 has three cables connecting to USB-C (In1), USB-B (In3), HDMI (In3).

Case 1.

When the BYOD laptop uses HDMI for video and USB-B for data.

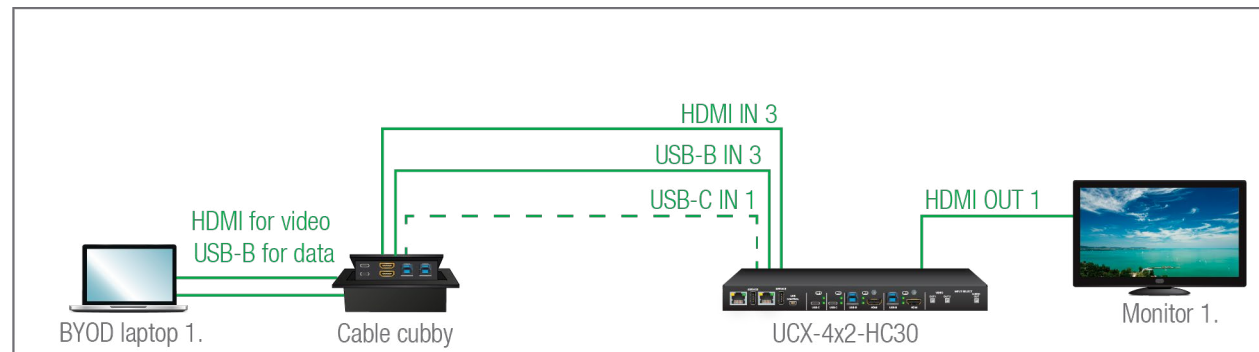

Case 2.

When the BYOD laptop uses HDMI for video and USB-C for data.

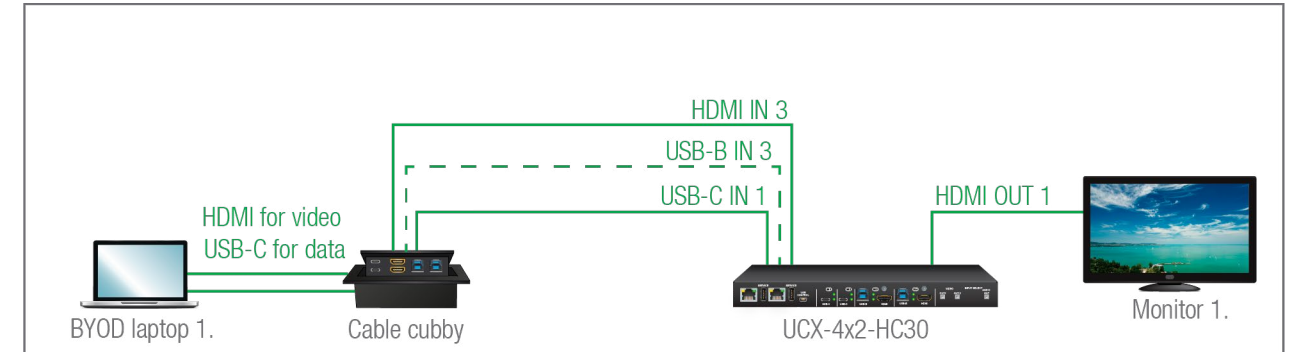

Case 3.

When the BYOD laptop uses USB-C for video and data and USB-C for data.

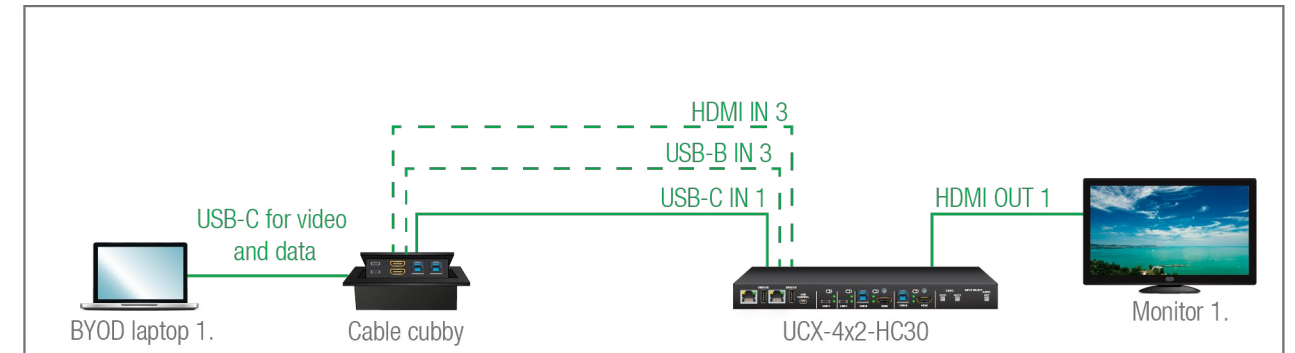

The individual input settings are the following:

Video

O1: Last detect; I1 priority:1; I2: disabled; I3 priority:1; I4: disabled; I5 priority:2



ATTENTION! Take care that the O2 video is not switched to I5 because of the crosspoint limitation: I1 and I5 ports are not available at the same time, only one of them can be selected to any output.

USB

H1: Last detect, U1 priority:1; U2 priority:1; U3 priority:1; U4 priority:1

5.5. Audio Interface

Summary of Audio Ports

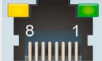
	Audio Outputs	
	Analog audio de-embedding	
		
	5-pole Phoenix Combicon	RJ45
UCX-2x1-HC30	✓	-
UCX-2x1-HC40	✓	-
UCX-2x2-H30	✓	-
UCX-2x2-H40	✓	-
UCX-4x2-HC30	✓	-
UCX-4x2-HC40	✓	-
UCX-4x2-HC30D	✓	✓
UCX-4x2-HC40D	✓	✓
UCX-4x3-HC40-BD	✓	✓*
UCX-4x3-HC40	✓	-
DCX-2x1-HC10	✓	-
DCX-3x1-HC20	✓	-

* The DANTE port is both input and output in case of the UCX-4x3-HC40-BD model.

INFO: The -LCC models have the same values as non-LCC models.

Video and Audio Port Diagram (UCX-4x2-HC30D, UCX-4x2-HC40D)

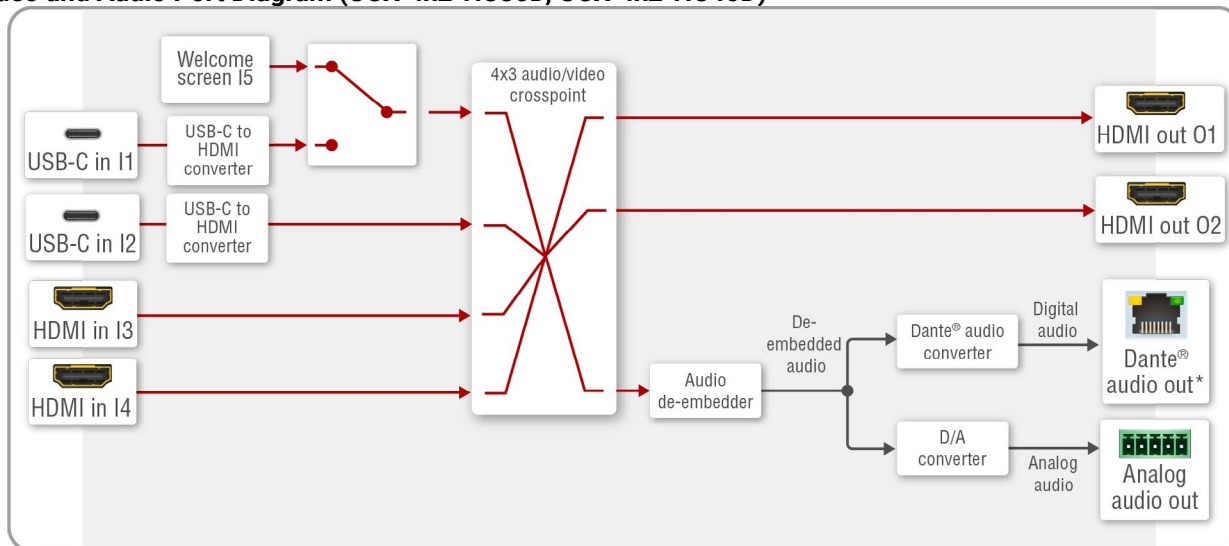

Audio Port Diagram (UCX-4x3-HC40-BD)

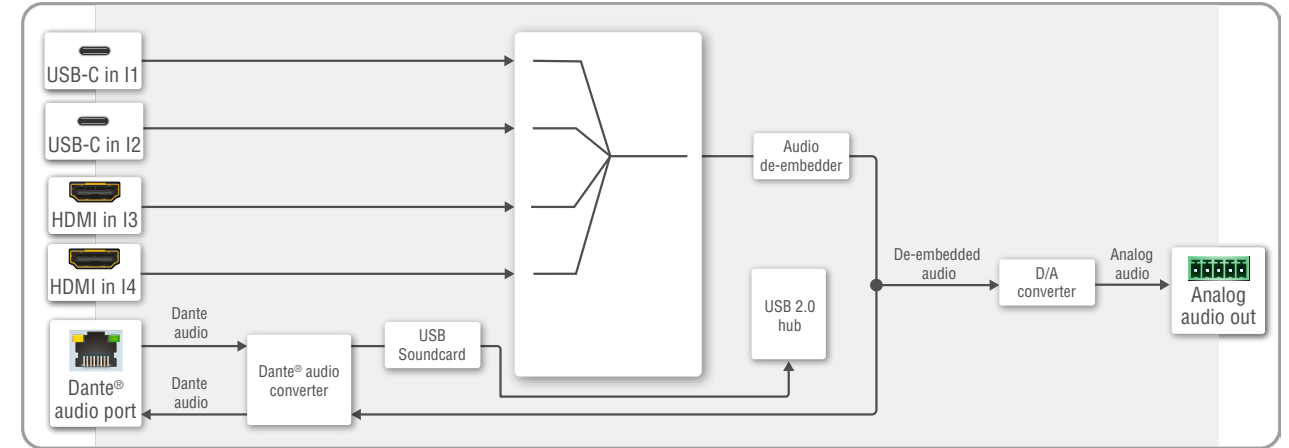

5.5.1. Analog Audio Interface

The device can receive embedded audio signal on the HDMI or USB-C inputs.

The switcher has a built-in audio de-embedder, which means the device is able to de-embed audio from its video ports to its analog audio output port.

ATTENTION! Audio can not be de-embedded from I1 to O3 as long as I5 is in use. This is due to the mutually exclusive operation of I1 and I5 ports. Embedded audio signal present will read false in the case described above.

5.5.2. Dante® Audio Interface

DIFFERENCE: The following section refers to the UCX-4x2-HC30D, UCX-4x2-HC40D and UCX-4x3-HC40-BD models.

The UCX-4x2-HC30D, UCX-4x2-HC40D and UCX-4x3-HC40-BD models contain a special module that allows the de-embedding of the audio stream from the incoming HDMI signal and transmitting it as a 2-channel Dante® or AES67 source over the dedicated RJ45 connector. The chosen audio signal is mirrored to the analog audio port. #dante #audio

The same signal is sent to both analog and Dante® audio outputs. Both can be muted at the same time by changing the O3 port setting in the audio crosspoint: /MEDIA/AUDIO/XP/O3.Mute

The following command is exclusive to the analog port O3: /MEDIA/AUDIO/O3.Mute

INFO: In case of the UCX-4x3-HC40-BD model, the analog audio output port is O4.

Supported Audio

Input audio type	Signal support
2-ch LPCM **	supported
Multichannel	not supported
Compressed DTS/Dolby	not supported

** The supported sample rates are 44.1, 48, 88.2 and 96 kHz.

Dante® is a registered trademark of Audinate Pty Ltd.

Important Notes

- The AES67 mode is supported by the UCX-4x2-HC30D, UCX-4x2-HC40D and UCX-4x3-HC40-BD, which can be set in the Dante® Controller software.
- Multichannel or encoded audio format cannot be de-embedded. In this case, no audio is sent to the Dante® network.
- In case of UCX-4x3-HC40-BD, incoming Dante® audio is also processed without need for external DSP or Dante/USB dongle.

Settings and Signal Routing

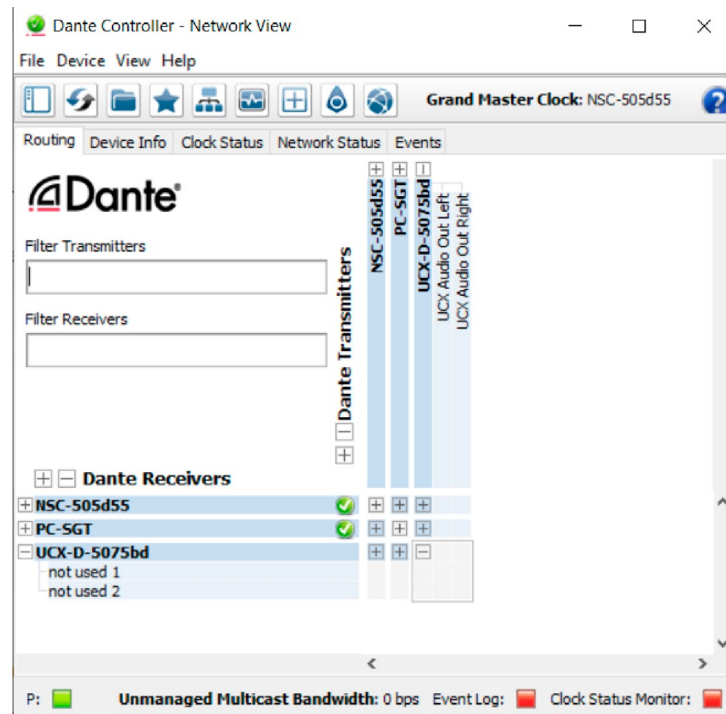

All these features are available in the Dante® Controller software, which can be downloaded from the manufacturer's web page:

<https://www.audinate.com/products/software>

Device Settings

The discovered Dante®-compatible devices are displayed with middle-blue color. Double-click on the name to open the device settings.

The default device name is:

UCX-D-<Dante_MAC_address_last 6_characters>

It can be changed under the Device config tab. Similarly, the channel names can also be changed. NSC-01 is another device with Dante® audio interface.

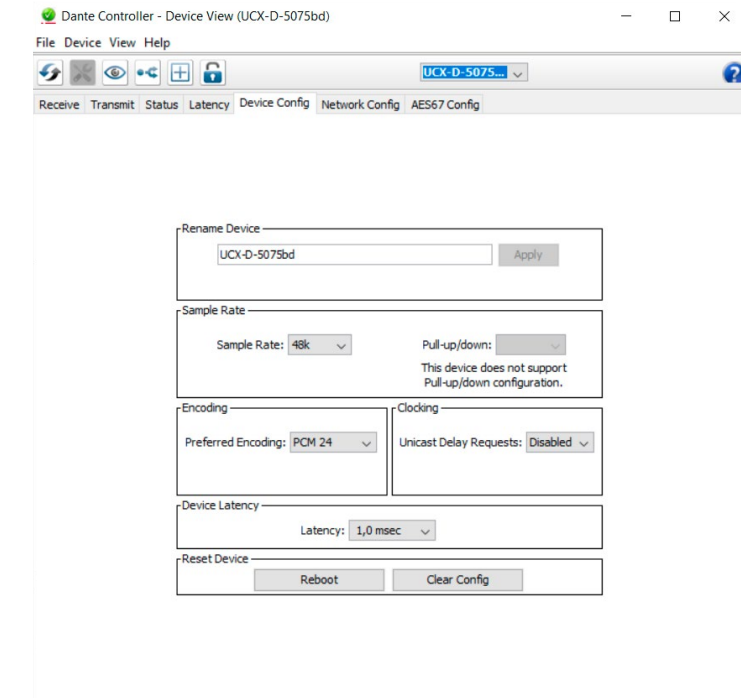

Press the  button to identify the device: the LEDs of the RJ45 connector will blink six times in red.

5.5.3. Dante® Audio Input

DIFFERENCE: The following section refers to the UCX-4x3-HC40-BD model.

USB-Audio Configuration

The USB crosspoint allows connecting the USB hub to one of the USB inputs (USB-C or USB-B). When a PC/laptop is connected to a USB input port, the Operating System (OS) of the computer will recognize the Dante® interface as a new Audio device (sound card). This feature allows assigning an Audio input device (e.g. microphone) to the PC/laptop connected to the USB port – over the Dante® network. A typical example is when a microphone is in the Dante® network (e.g. in the meeting room) and it can be used as an audio input device for the laptop during a meeting – see the figure below:

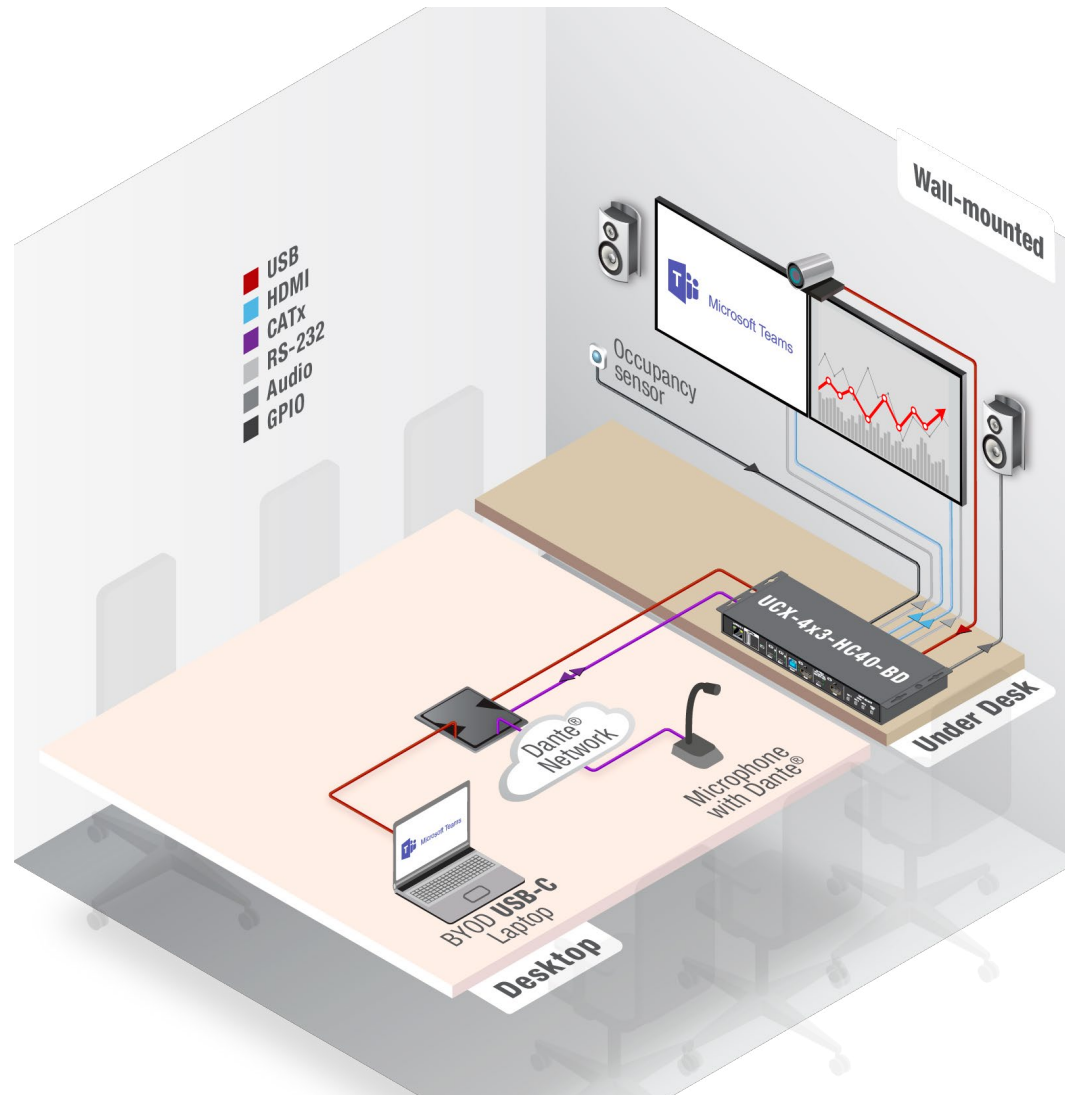

The module was designed to support special audio functions, too. Due to the differences between microphone types, the USB-Audio device class Terminal type can be changed. Thus, the OS will handle the microphone correctly. The desired Terminal type can be selected from the drop-down menu as follows:

Audio Device Type	PID *	Description
Microphone (default)	017B	A hands-free audio device designed for host-based echo cancellation.
Echo-suppressing microphone	017A	A hands-free audio device with echo suppression capable of half-duplex operation.
Echo-canceling microphone	0179	A hands-free audio device with echo cancellation capable of full-duplex operation.
Line IO	017C	For troubleshooting and testing purposes only.

* The PID number is visible for the OS, see the example from Microsoft Windows 10:

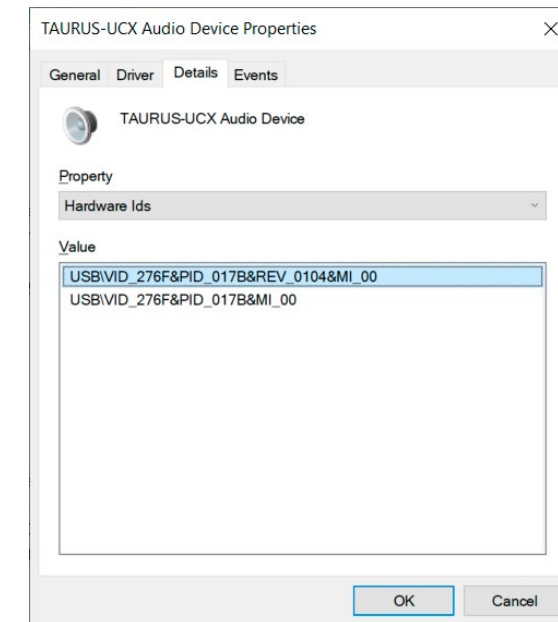

This can be set in any of the following ways:

- Lightware Device Controller, see the [USB-Audio Configuration](#) section.
- REST API POST message, see the [Setting the Audio Device Type for the Dante Input](#) section.
- LW3 command, see the [Setting the Audio Device Type for the Dante Input](#) section.

INFO: Please set the Audio Device Type according to the Microphone type.

Signal Processing and Sampling

The Dante® USB Audio Bridge is able to receive and send different audio formats. The following table sums up the internal working of the module:

Input		Internal signal processing	Output	
Format	Sampling Frequency (Fs)		Sampling Frequency (Fs)	Format
HDMI audio 2ch LPCM	22.5 - 192 kHz	Sampling Frequency = 48 kHz BitDepth = 32 bit/sample	48 kHz	HDMI audio 2ch LPCM
SPDIF audio 2ch LPCM	22.5 - 192 kHz		48 kHz	SPDIF audio 2ch LPCM
Dante® audio 2ch LPCM	44.1 - 96 kHz		Output Fs = Dante® input Fs	Dante® audio 2ch LPCM
USB audio (Host Playback) 2ch LPCM)	48 kHz		48 kHz	USB audio (Host Playback) 2ch LPCM)
Internal test tone	48 kHz		48 kHz	Internal test tone

USB Sound Card

The USB sound card in the device can be enabled or disabled, depending on the usage. If it is **enabled**, the OS will recognize it as a sound card, allowing a Dante® audio **input** device (e.g. microphone) to be assigned to the PC/laptop. If it is **disabled**, it allows for a Dante® audio **output** device (e.g. speakers) to be used.

Enabling or disabling the USB sound card is possible via the following ways:

- REST API POST message, see the [Enabling/Disabling the Dante USB Sound Card](#) section.
- LW3 command, see the [Enabling/Disabling the Dante USB Sound Card](#) section.

5.6. Ethernet Interface

Summary of Ethernet ports

	USB-C	Secure Control Ethernet (Ethernet 1)	Utility Ethernet (Ethernet 2)	Configurable Ethernet (Ethernet 3)
				
UCX-2x1-HC30	1x	✓	✓	✓
UCX-2x1-HC40	1x	✓	✓	✓
UCX-2x2-H30	-	✓	-	-
UCX-2x2-H40	1x	✓	-	-
UCX-4x2-HC30	2x	✓	✓	✓
UCX-4x2-HC40	3x	✓	✓	✓
UCX-4x2-HC30D	2x	✓	✓	✓
UCX-4x2-HC40D	2x	✓	✓	✓
UCX-4x3-HC40-BD	2x	✓	✓	✓
UCX-4x3-HC40	2x	✓	✓	✓
DCX-2x1-HC10	-	✓	-	-
DCX-3X1-HC20	-	✓	✓	✓

INFO: The -LCC models have the same values as non-LCC models.

Ethernet Port Diagram

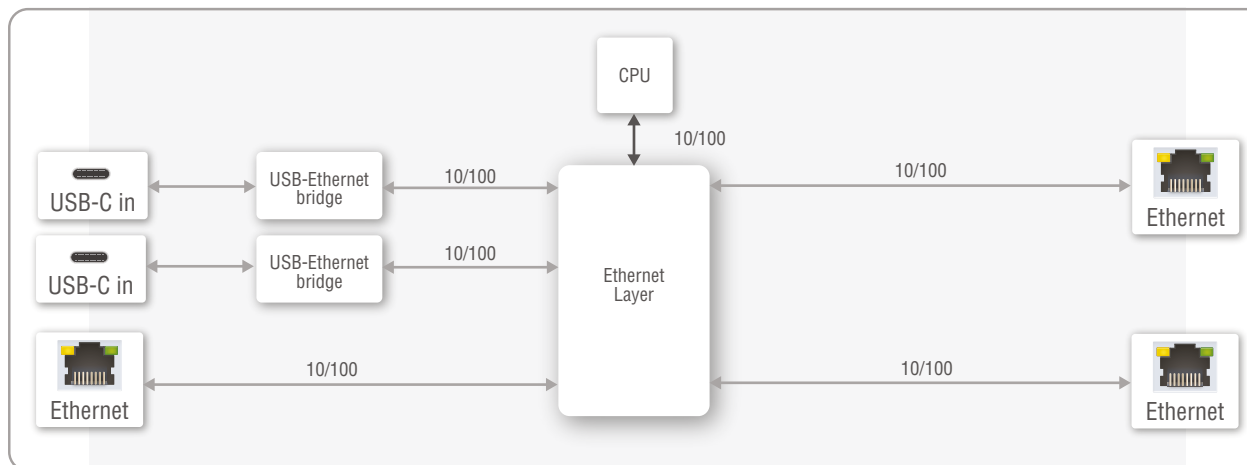

*UCX-2x2-H30 model has two Ethernet ports.

The device can be controlled via Ethernet (standard RJ45 connector). This interface supports:

- Configuration of the device with Lightware Device Controller. For more information about the LDC, see the [Software Control Options](#) section.
- Control of the Lightware devices with LW3 command protocols. See more details about the Lightware protocol in the [LW3 Programmers' Reference](#) section.
- Establishing the connection to the Lightware Device Updater v2 software and performing Firmware Update.
- Creation of a local network, passthrough the Ethernet traffic.

From v1.2.0 firmware package:

- The switcher provides WS/WSS services on its 80 (for WS) and 443 (for WSS) ports to control the device with LW3 protocol commands. For more details, see the [WebSocket Service \(WS, WSS\)](#) section.
- REST API interface is also designed for control UCX switcher. See more details in the [Lightware REST API Reference](#) section.

USB- Ethernet Bridge

The built-in USB- Ethernet bridge provides Ethernet for the USB-C connection. It is still available while the USB 3.1 Gen1 data channels are reserved for video or USB data transmission, as it uses the USB-2.0 layer.

System Requirements of USB- Ethernet Bridge

The built-in USB- Ethernet bridge operates as a third-party USB Ethernet hub.

- Windows operation systems handle it plug and play.
- MacOS X operation systems require driver installation. Please find the driver on the following link: https://www.microchip.com/en-us/software-library/obj-lan95xx-mac_os_x

ATTENTION! Enabling the third-party device operation is necessary (System Preferences -> Security & Privacy -> General -> Allow software driver from "Microchip").

- For the other operation systems, please find the driver on the following link: <https://www.microchip.com/en-us/product/LAN9512>

5.7. Lightware Advanced Room Automation (LARA)

Lightware Advanced Room Automation (LARA) is a future-proof room automation platform that enables controlling both Lightware and 3rd-party devices in a meeting room area and also accessing remote services over the network. LARA has an easy-to-use graphical interface that allows the integrators to set up and deploy their system and also helps the technicians and IT personnel to check the system status and diagnose possible errors. LARA comes with built-in touchscreen control support, where a fully customizable graphical interface can be provided to literally any modern touchscreen device.



LARA eliminates the need for an external controller unit or PC, as it is embedded into the Taurus UCX family. Because of the modular design, the integrators can build their system based on existing modules (drivers, touch screens, services and more) or create their own. Thanks to the approach of open source modules, the integrators can easily modify or extend the existing modules, or use them as a base for their new solutions.

With LARA, integrators can set up the behavior of the meeting room by creating rules and setting various parameters, there is an option to write codes. JavaScript is the most widespread language today, which has a steep learning curve and huge online community. By using the popular NodeJS engine, the integrators can rely on the public NPM repository (<http://www.npmjs.org>) and use the free packages available there.

We are working hard to release new functionalities regularly and make LARA more and more user-friendly.

DIFFERENCE: LARA is available in UCX devices from FW version v1.5.0 and DCX devices from FW version v2.11.0.

5.7.1. Opening the LARA interface

ATTENTION! When connecting to a device, you will need the 443 port for HTTPS connection, and optionally the 6107 port for raw TCP connection and the 80 port for HTTP connection.

Step 1. Enable LARA in your device. Navigate to the Settings/Network tab. First set a password for the 'admin' user, then enable LARA via the checkbox.

INFO: As LARA is capable of running NodeJS scripts accessing your network, it is imperative to prevent open access that could be used by a malicious attacker.

Step 2. Open LARA in either of the following ways:

- Via the **Open LARA** button under the System tab in the LDC, or
- By typing `https://<ip_address>/lara` into the address field of your browser. Even though any modern browser should work, we recommend using the latest Chrome or Safari versions. If you don't know the IP address of your device, please use Lightware Device Controller to discover it on your local network.

LARA does not run by default, however, once it starts, it will remain running even after resetting the device or closing the browser, until it is stopped by the user. It can be disabled in the LDC software. Please be aware that calling factory reset will erase LARA configurations.

While a graphical interface is available for most of the general functions, LARA offers the option to use it with JavaScript codes for every step and modification for both basic and more advanced task creation. Wizard and JavaScript code usage can easily be combined for maximum efficiency.

Help

LARA offers a built-in help interface, which is available by clicking on the **Help** button near the top right corner. If you have active Internet connection, the [LARA User Manual](#) is available either via the QR code or the clickable link beneath it.

5.7.2. Running LARA

LARA uses modules and their instances as basic building blocks of a configuration.

Modules

Modules are software pieces that give a base to the processes in the LARA interface. There are five module categories available as follows:

- **Driver:** a module connected to a certain device in the network
- **Logic:** a module for organizing the other modules into a system
- **Userpanel:** provides a user interface for the end user (e.g. tabletop control)
- **Service:** a module connected to a certain service in the network (e.g. calendar services)
- **Script:** any custom module for a specific purpose

LARA modules have access to the devices' every port, connection interface and the entire parameter library of the LW3 tree.

There are several pre-made modules that can be found in LARA for quick and easy system setup. These modules can be found in the **Browse Modules** menu by clicking on the **Create New** button and choosing one of the options from the **Base modules** drop-down list.

- **Taurus/MMX2 driver** module - for controlling the device
- **Taurus/MMX2 CEC driver** module - for sending CEC messages via the HDMI ports
- **Generic LW3 driver** module - for controlling another Lightware device that supports LW3 protocol
- **Generic TCP/IP driver** module - for controlling any device that is available via TCP/IP connection
- **Cisco Webex script** module - integration with Cisco Webex supporting BYOD (Bring Your Own Device) functions
- **OCS sensor serial message script** module - for sending a serial message to a device (e.g. Display) if the Occupancy Sensor detects a signal
- **Generic REST Client driver** module: universal module for controlling third-party devices over HTTP(S) REST API (PUT, POST, GET, DELETE)
- **Signal present serial message script** module - for sending a serial message to a device (e.g. Display) if a video signal is detected on a port

Instances

Modules can be run as instances. Different parameters may be added to different instances for the same module to include every possible process in the desired system.

Instances can communicate with each other using **Events** and **Methods**.

ATTENTION! It is currently only possible to run all instances together, or run none of them.

Events

Every instance can emit Events when something happens. An event is always momentary, it will be emitted immediately when something triggers it. An event can be used by other logic or user panel instances, or even by the same instance itself.

Methods

Methods are software pieces in any instance, which can be invoked (called) to initiate an activity in the associated room equipment.

Rules

Rules allow setting up processes according to changes in the state of the device. A status change might dispatch an **Event**, which can trigger a rule. The rule will then be able to execute an **Action** according to the triggering Event. When defining a new rule, a triggering Event must be selected. In case of Logic and Userpanel modules any instance can be chosen as the source of the Event. In other cases only the given module's own Events may be selected.

Once an Event has been dispatched that triggered a rule, an Action will be launched. An Action may have an unlimited number of steps defined.

5.7.3. Downloading/Uploading a Configuration

The modules, or even the entire configuration can be downloaded to the computer as a .zip file, or a previously saved configuration can be uploaded to a device.

ATTENTION! If the links to methods/properties are compatible with other models within the UCX/MMX2 product family, the configuration will work without a problem. However, sometimes a simple fine tune in the LW3 path of the properties/methods is necessary.

In case of downloading (and later uploading) a configuration of the module, these files are contained within the .zip file.

5.7.4. Status Board

The Status board offers real-time information about the connected devices through all running instances as Status Indicators. Such information might include connection status, signal presence, or even parameter status tracking. The indicators may show either static or self-refreshing information based on the current states of the device.

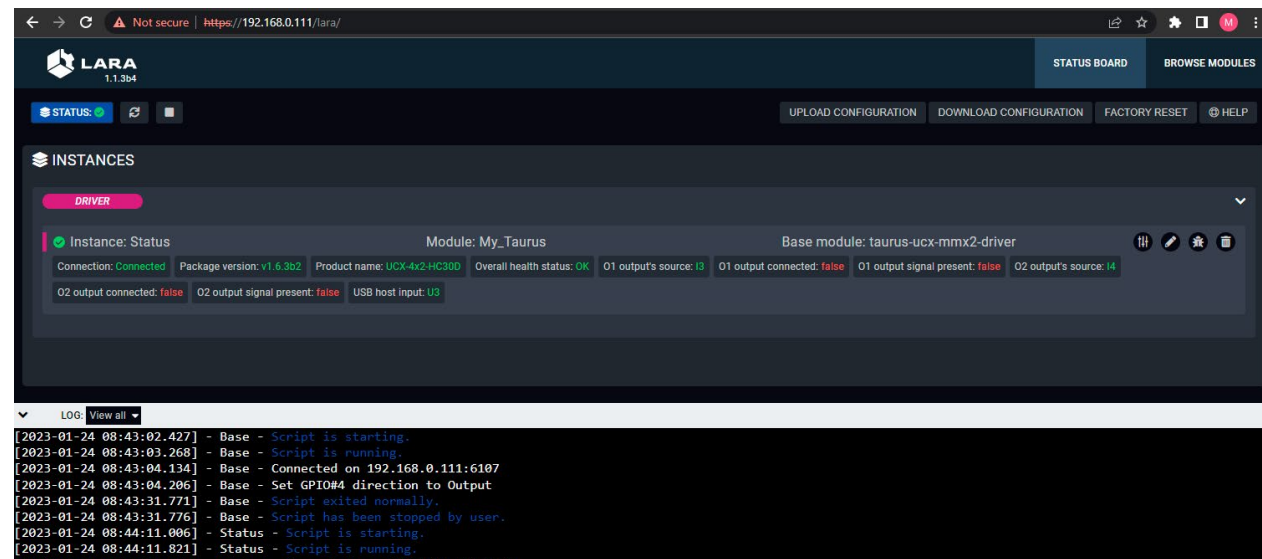

5.7.5. Touch Panel Support

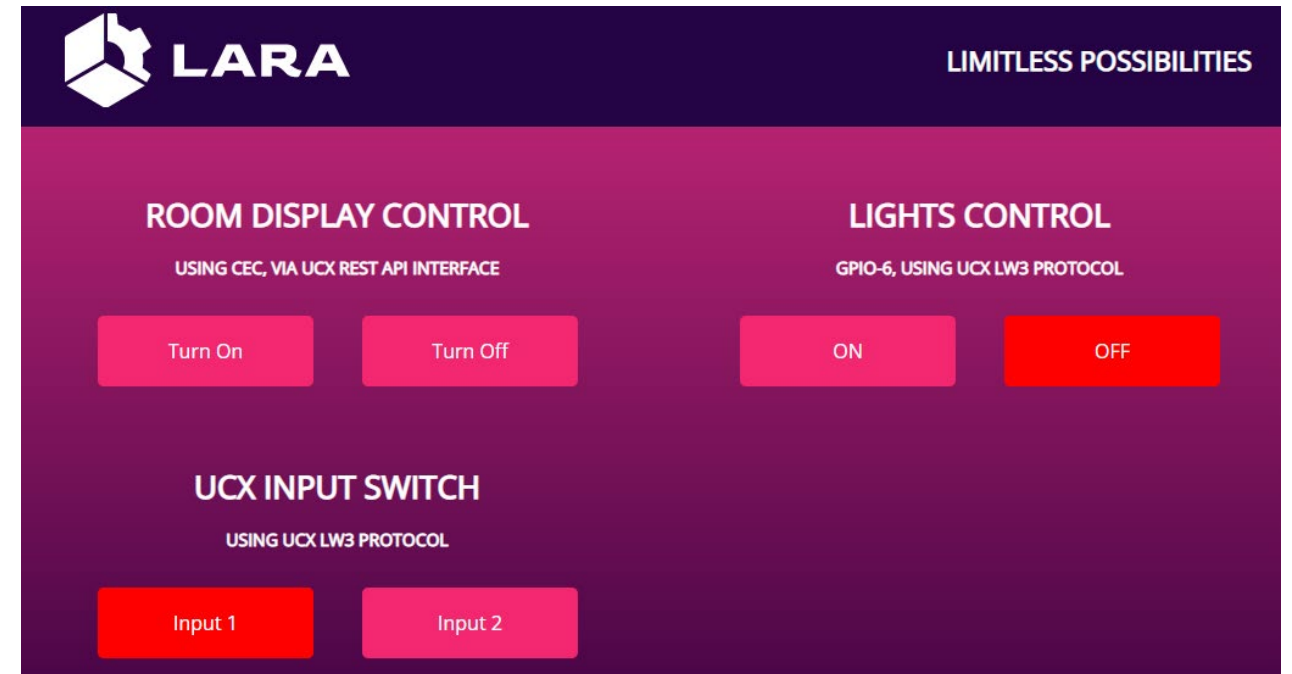

LARA offers support for any touch panel device that has a browser installed on it. With the use of Userpanel modules, you can easily upload project specific HTML/CSS/JS files to your devices, and edit or change them in LARA in real time. There is a Content option under a Userpanel module for the purpose of uploading and editing these files. It is also possible to create folders and subfolders for easy organization. Uploading can be done by dragging and dropping the files into the content section.

For proper operation, in the HTML code a unique ID shall be assigned to every HTML element where LARA interaction is required.

For more information, sample configurations and training materials, please visit lightware.com/lara.

WARNING! Enabling LARA on your device will open TCP ports 20,000 to 30,000 for service deployment. These ports will not be protected or filtered by the device's firewall, making them accessible from the device's network interfaces. Please be aware that running services on these ports could expose potential vulnerabilities on the device. Make sure to only activate services that have undergone thorough testing and do not contain any vulnerabilities.

5.8. Basic Network Security

DIFFERENCE: The basic network security feature is available only from FW package v1.2.0.

These basic network security improvements help to prevent unauthorized access to the UCX series switchers:

- Disable Ethernet Ports
- Disable Network Services
- Basic Authentication
- Encryption (HTTPS, WSS)

The following table summarizes the ports, protocols, features and the security options.

Port number	Protocol	Function	Affected software	Port disable option	Encryption	Authentication	Other features
80	TCP	HTTP port (LW3 over WS, REST API, LARA user panels)	LDC, LDU2	✓	✗	✓	FW update, Welcome Screen image upload, Log files, User Scripts Serial messaging
443	TCP	HTTPS port (LW3 over WSS, REST API, LARA management GUI)	LDC, LDU2	✓	✓	✓	
6107	TCP	LW3 protocol	LDC	✓	✗	✓	
8001, 8002	TCP	Serial over IP (RS-232)	-	✓	✗	✗	
224.0.0.251: 5353	UDP	mDNS / Bonjour (Device Discovery)	LDC, LDU2	✗	✗	✗	
230.76.87.82: 37421	UDP	Remote IP	LDC, LDU2	✗	✗	✗	

INFO: The ports are necessary to be passed via a network switch/firewall for proper operation between the device and the softwares.

ATTENTION! Be careful when combining the security functions; improper settings may cause malfunction.

5.8.1. Disable Ethernet Ports

Internal Ethernet connections can be limited by enabling/disabling the Ethernet ports depending on the actual system configuration (e.g. Ethernet layer of the USB Type-C port can be disabled if necessary).

5.8.2. HTTP/HTTPS

UCX series switcher provides HTTP/HTTPS server services on its 80 (for HTTP) and 443 (for HTTPS) ports. It makes it possible to use the following services via HTTP/HTTPS:

- LW3 over WebSocket (WS, WSS) for LW3 protocol or using LDC for device control
- REST API for device control
- Serial message sending with REST API
- Firmware update
- Uploading WelcomeScreen image
- Uploading UserScripts
- LARA interface
- Downloading logfiles from the device

DIFFERENCE: UserScripts are only available with up to firmware version v1.4.4. From firmware version v1.5.0, LARA replaces functions previously managed by UserScripts.

ATTENTION! LARA management GUI is only available through HTTPS and it is password-protected.

Basic Authentication

To limit user access for HTTP/HTTPS server services, basic authentication can be turned on for the ports 80 and 443 separately.

ATTENTION! Authentication feature in UCX series is not equal to the Cleartext login feature in the Advanced Control Pack v3 of the TPS family extenders.

The picture below illustrates the successful authentication process:

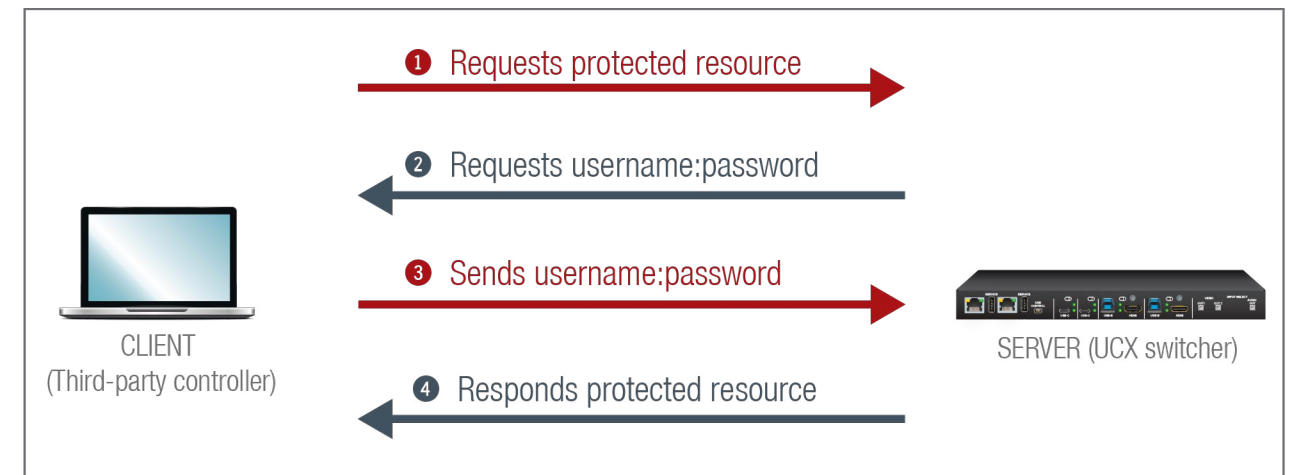

User

- The switcher can manage one user (with fixed username: admin) with full access.

Password

- No password is set by default, the authentication can be enabled after setting a password. The old password is not necessary for modifying prior to firmware version v2.0.0. From that version on, the old password is required when password is changed.
- From firmware version v2.2.0, the password must be at least 10 characters long, and any UTF-8 character is allowed.
- From firmware version v2.11.0, password history is maintained in the web authentication, not allowing for the last 10 passwords to be set again.
- The device does not store the password string, so it can not be queried.
- The password can be reset by calling factory defaults ([Reset to Factory Default Settings](#)).

Follow the instructions to set the authentication:

Step 1. Set the password with Lightware Device Controller software ([Network](#)) or REST API command ([Setting a Password for Authentication](#)).

Step 2. Enable the authentication on the chosen port (HTTP: 80 or HTTPS: 443) with the Lightware Device Controller software ([Network](#)) or LW3 protocol command ([Enabling the Authentication](#)).

Step 3. Restart network services.

ATTENTION! The password will not be encrypted by this authentication mode, it remains accessible when the communication happens on HTTP.

5.8.3. Encryption (HTTPS, WSS)

HTTP protocol uses clear text format for data transport. This method allows a third-party to listen in and eavesdrop on the transferred information.

HTTP request-response

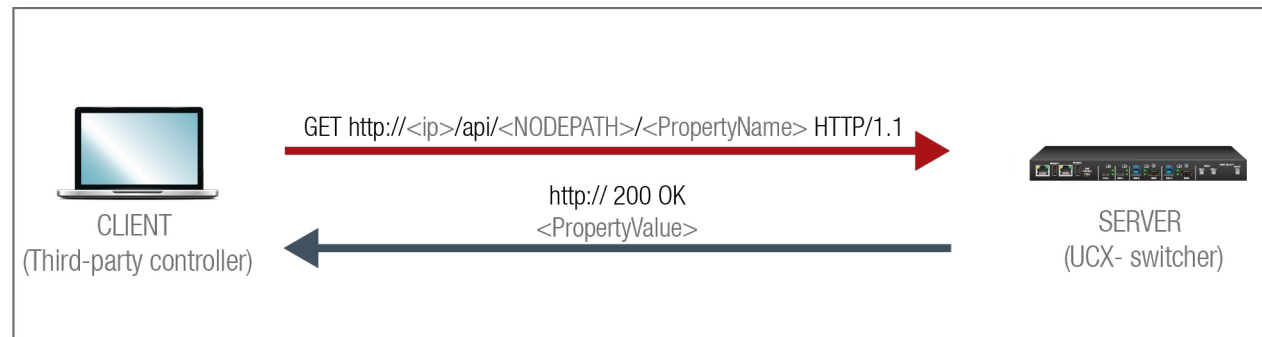

To ensure the secure data transmission, the HTTP port (80) can be disabled, and the all the information can be transferred via HTTPS (443 port). HTTPS protocol encrypts the clear text, so it becomes incomprehensible for a third-party and keeps the data secure.

HTTPS request-response

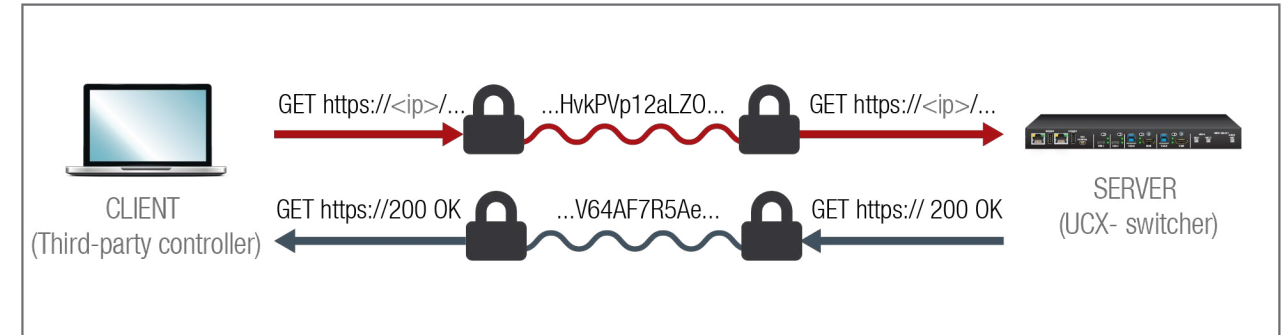

The same services are available on HTTPS as HTTP (for the detailed service list, see the [HTTP/HTTPS](#) section).

- The UCX series switcher generates a self-signed certificate, so the user does not have to deal with the configuration.
- From firmware version v2.2.0, SSL certificates can also be uploaded into the device ([Certificate Management](#)).
- A new certificate is generated after hostname changing or restoring the factory default settings.
- Please ensure proper UCX time and date setting in UCX, because it affects the self-signed certificate (SSL) generation when using WSS or HTTPS. Improper time and date setting may lead to certificate rejection.

ATTENTION! HTTPS does not guarantee that the communication is secure. Make sure that the client communicates with the server directly, without any third-party element in the communication route (Man-in-the-middle attack).

Basic Security System Example

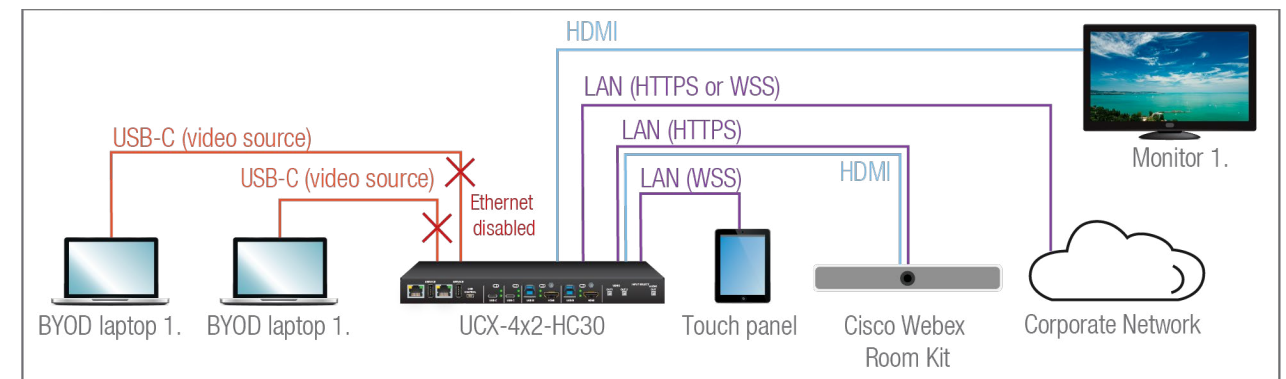

To keep the system protected, the unsecured ports should be disabled and data traffic should be managed by secured channels.

Step 1. Disable the Ethernet layer of the USB-C ports towards the laptops. The video and USB data transmission still work.

The setting is available in the following ways:

- Lightware Device Controller software (see the details in the [Ethernet](#) section)
- Lightware REST API HTTP posts (see the details in the [Network](#) section)
- LW3 protocol commands (see the details in the [Enabling/Disabling the Ethernet Port](#) section)

Step 2. Disable the HTTP port (80) and use HTTPS (443) instead.

The setting is available in the following ways:

- Lightware REST API HTTP posts (see the details in the [Enabling/Disabling the Network Service Port](#) section).
- LW3 protocol commands (see the details in the [Enabling/Disabling the Service Port](#) section).

Step 3. Set the password and enable the authentication.

The username is always fix (admin) and the password has to be set before authentication is enabled. The setting is available in the following ways:

- Lightware Device Controller software (see the details in the [Network](#) section)
- Lightware REST API HTTP posts (see the details in the [Setting a Password for Authentication](#) and the [Enabling the Authentication](#) section).

Step 4. Disable 6107 port, use Lightware REST API HTTPS (443 port) or WSS for LW3 protocol to control the device.

The setting is available in the following ways:

- Lightware REST API HTTP posts (see the details in the [Enabling/Disabling the Network Service Port](#) section).
- LW3 protocol commands (see the details in the [Enabling/Disabling the Service Port](#) section).

Step 5. Disable the remaining unsecured Serial over IP ports (8001 and 8002).

The setting is available in the following ways:

- Lightware REST API HTTP posts (see the details in the [Enabling/Disabling the Network Service Port](#) section).
- LW3 protocol commands (see the details in the [Enabling/Disabling the Service Port](#) section).

5.9. 802.1x Authentication

802.1x is a server-based port authentication protocol that restricts unauthorized clients from accessing a LAN through a public port. Three parties make up the most basic setup of 802.1x: a supplicant (client device), an authenticator (Ethernet switch) and an authentication server. Before the device is permitted access to the network, port communication is restricted to Extensible Authentication Protocol over LAN (EAPOL) traffic.

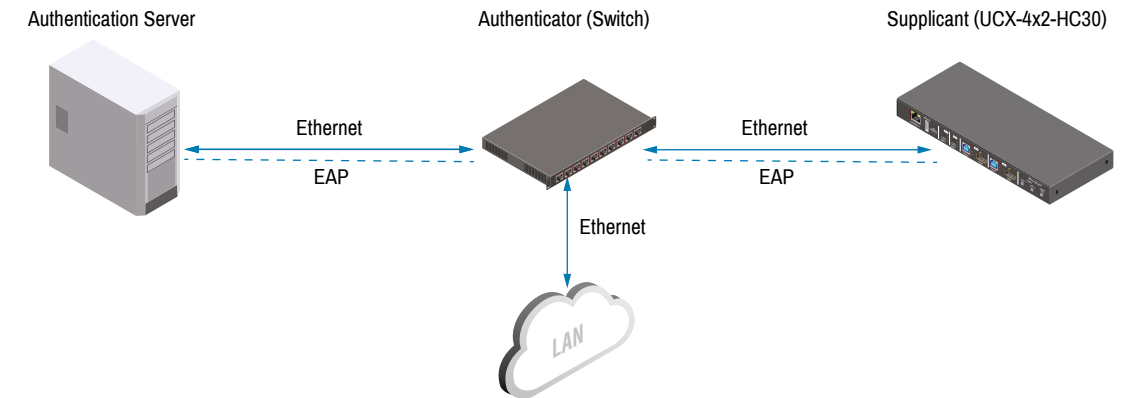

After the device passes the authentication process, the authentication server notifies the switch, allowing the client to access the LAN.

There are two available methods for 802.1x authentication in the UCX devices:

- **EAP-MD5:** This commonly used method authenticates by verifying MD5 (Message Digest 5) hash of a user password.
- **EAP-TLS:** This method utilizes Public Key Infrastructure to authenticate with an authentication server. To communicate with the server, a certification authority (CA) certificate and a client-side certificate that is signed by a known certification authority are needed.

DIFFERENCE: From firmware version v2.12.0, EAP-MD5 authentication is unavailable.

The UCX itself can act as a supplicant, but also as a route through which a BYOD device can reach the authenticator as a supplicant.

ATTENTION! This method authenticates the UCX device, not the BYOD connected to the UCX! If you only want to authenticate the connected BYOD device and not the UCX, you do not need to activate 802.1x authentication in the UCX device.

ATTENTION! If your device is using the **Dedicated** VLAN preset and the BYOD device is disconnected from the UCX, please be aware that the Ethernet port connected to the affected USB-C port will be blocked. You will be asked to authenticate again upon reconnecting a BYOD device. In **Transparent** mode the port blocking function is inactive.

INFO: When updating the firmware of the UCX device, sensitive information (passwords, keys etc.) on the authentication will not be downloaded into the backup file, but it will be retained in the device during the update.

5.10. Advanced Ethernet Security

DIFFERENCE: The advanced ethernet security feature is available only from FW package v1.6.0.

This feature is a port-based VLAN setting, which allows the user to decide which network(s) the USB-C ports are connected to, and thus which network(s) the connected devices can use. This way the connected devices can be separated from the corporate network, increasing network security.

These application diagrams offer a simple breakdown of the different modes of the feature.

There are three options available, which are the following:

- **Transparent:** this is the default mode, with the network openly used by Taurus and the BYOD devices. If you want to authenticate the connected BYOD through 802.1x, this option is not recommended.
- **Separated BYOD:** the network provided for the BYOD devices is separated from the control network. If you want to authenticate the connected BYOD through 802.1x, then the 802.1x authenticator port must support multi-authentication.
- **Dedicated:** each connected BYOD device receives an independent network. If you want to authenticate the connected BYOD device(s) through 802.1x, the 802.1x authenticator port can be single-host, however make sure every BYOD is connected to the UCX via a CATx cable.
- **Custom:** the user can sort the Ethernet ports into separate groups.

INFO: Only one mode can be active at the same time.

For more information about the feature, please visit our website (www.lightware.com) and download the [Taurus UCX Advanced Ethernet Security Application Notes](#).

5.10.1. Transparent

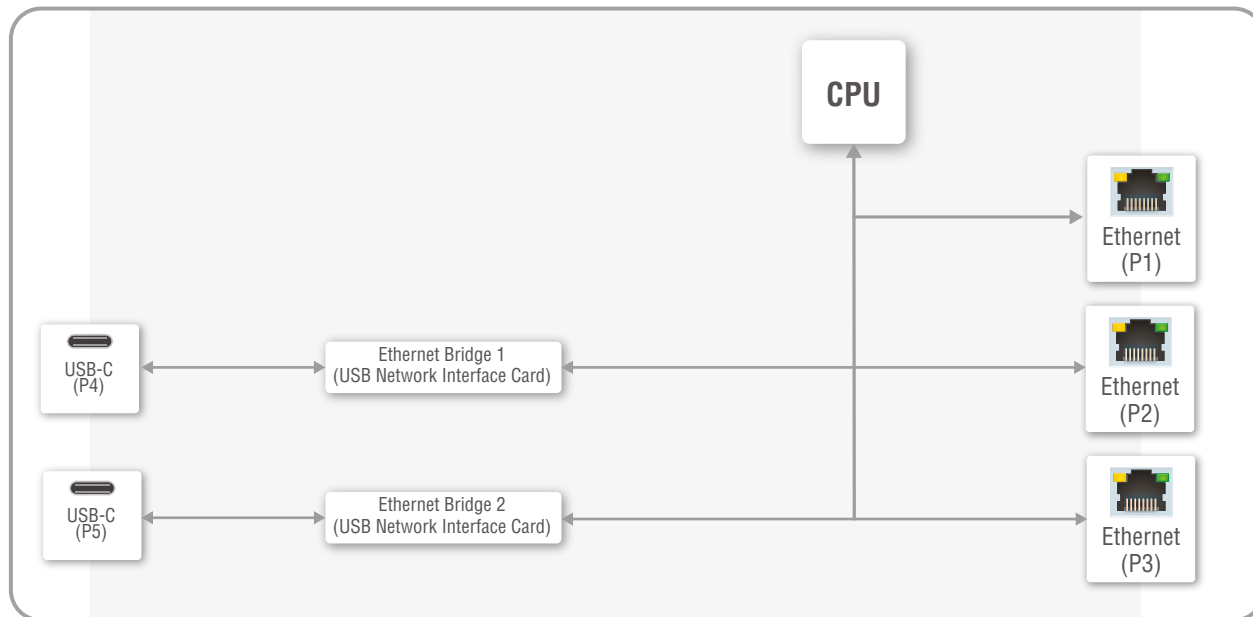

Transparent VLAN preset in UCX-4x2-HC30(D)

5.10.2. Separated BYOD

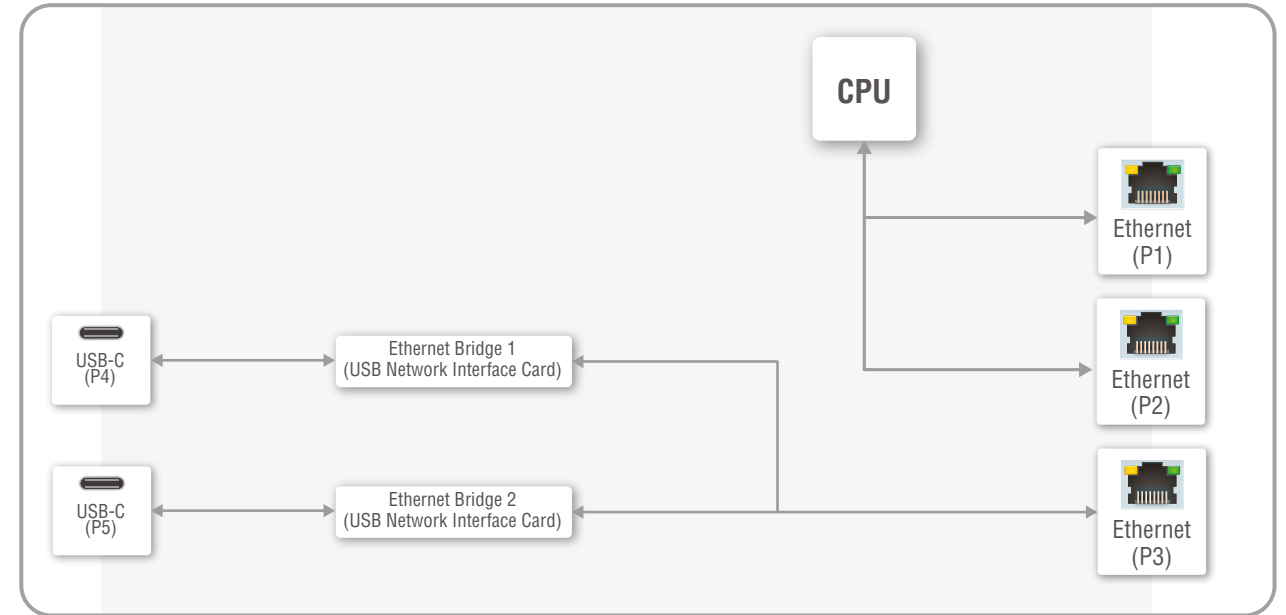

Separated BYOD VLAN preset in UCX-4x2-HC30(D)

5.10.3. Dedicated

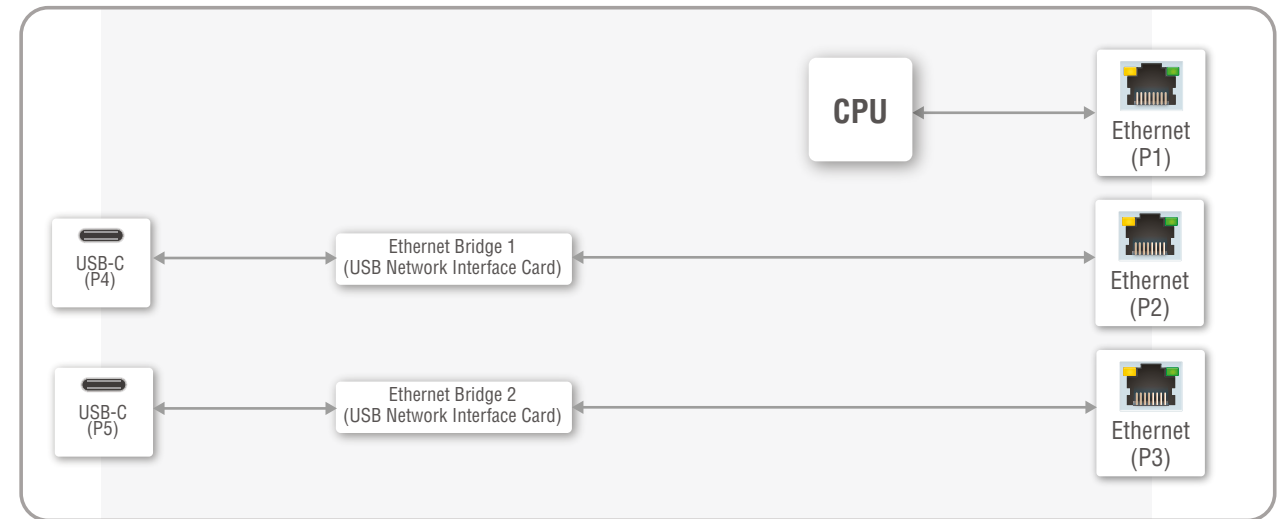

Dedicated VLAN preset in UCX-4x2-HC30(D)

5.10.4. Custom

DIFFERENCE: This setting is available from FW version v2.9.0.

The custom VLAN setting enables the user to set up their own Ethernet networks by putting the ports in separate groups. An Ethernet switch inside the device acts like a crosspoint for the Ethernet ports. Any VLAN setting that does not fall into the premade categories (Transparent, Separated BYOD or Dedicated) will be classified as **Custom**.

INFO: This mode cannot be directly chosen - it automatically changes to this mode when the settings are changed accordingly.

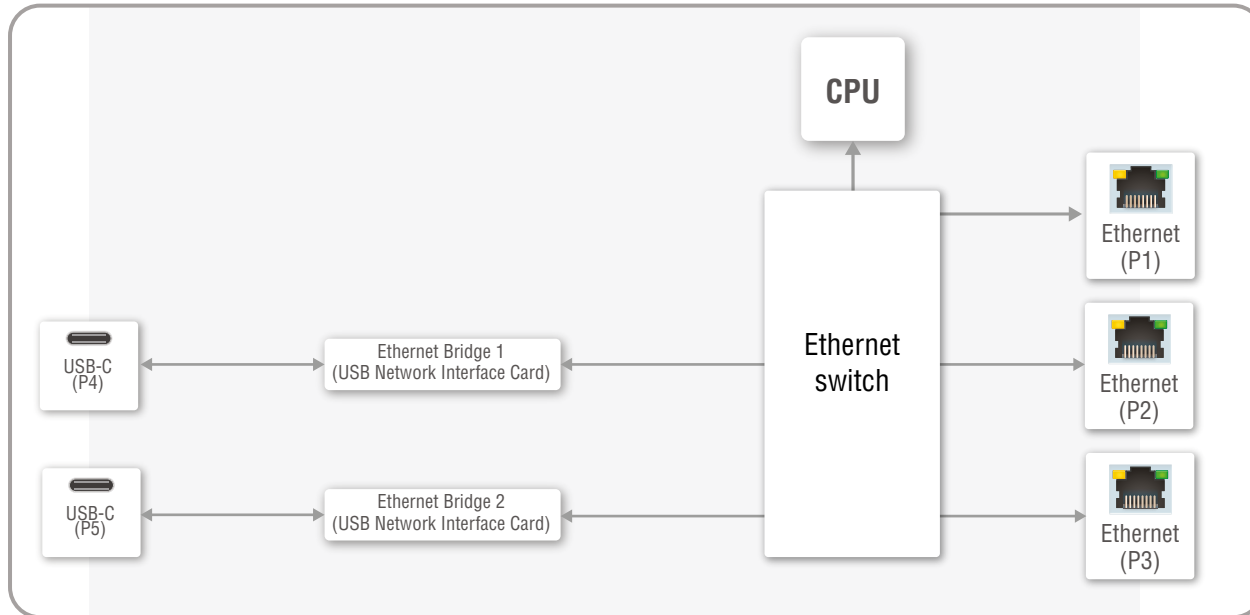

Custom VLAN preset in UCX-4x2-HC30(D)

5.11. Lightware Crypto Core

Lightware Crypto Core is a standards-based cryptographic engine for embedded Linux systems. The module delivers core cryptographic functions to the embedded systems of Taurus product family's hardware devices and features robust algorithm support.

#fips #new

It also offloads functions for secure key management, data integrity, data at rest encryption, and secure communications to a trusted implementation.

Lightware Crypto Core is Lightware's own FIPS 140-2-validated, Level 1-certified, cryptographic software module that is integrated into Taurus UCX products.

DIFFERENCE: This feature is only available in the -LCC models of the UCX family.



5.12. WebSocket Service (WS, WSS)

DIFFERENCE: The websocket service feature is available only from FW package v1.2.0.

UCX series switcher provides WS/WSS services on its 80 (for WS) and 443 (for WSS) ports to control the device with LW3 protocol commands.

The UCX series switcher can manage 18 connected clients in total simultaneously for WS (80), WSS (443) and LW3 (6107) ports.

The WebSocket connection is built up by HTTP handshake. After the connection is established, communication switches to a bi-directional WebSocket protocol for LW3 communication.

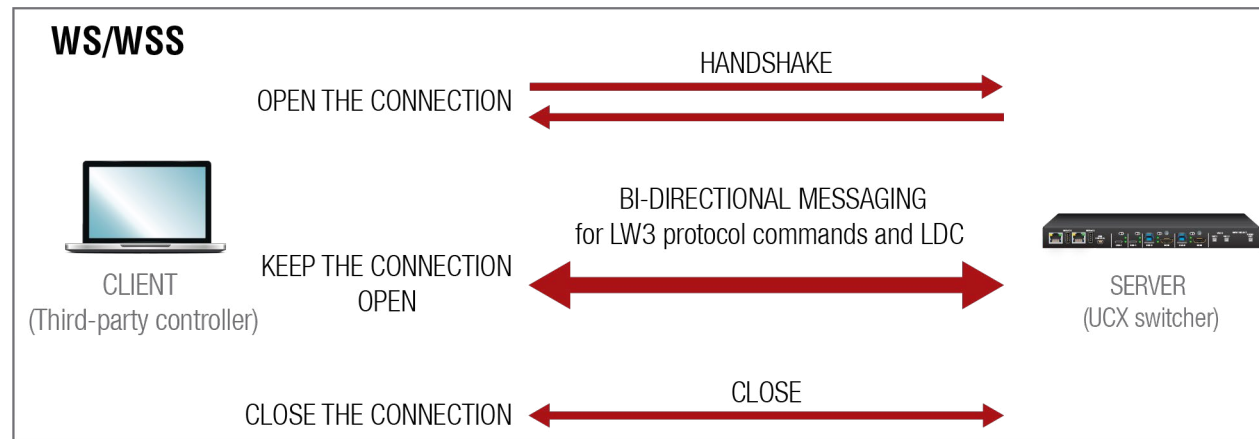

The main difference between HTTP and WS communication process is that HTTP closes the connection between the client and the server after one request-response pair, while WebSocket keeps the connection open. This feature allows real-time communication such as **controlling the device with LW3 protocol commands**. The WS functions are also available via WebSocket Secure (WSS).

5.13. Bulk Device Management

It is possible to configure several devices at once with the Bulk Device Management tool. This feature can be accessed by clicking on the **Tools** button in the bottom left corner of the Device Discovery window of the LDC and choosing the Bulk Management option.

See the [Bulk Device Management](#) section for more details.

5.13.1. Network Settings

This function makes it possible to change and adjust the network settings of several devices at once (unique settings for each device), without having to set them at each device one by one. A .csv file can be created containing the list and desired settings of the devices and it can be uploaded into the LDC to be applied to the devices quickly.

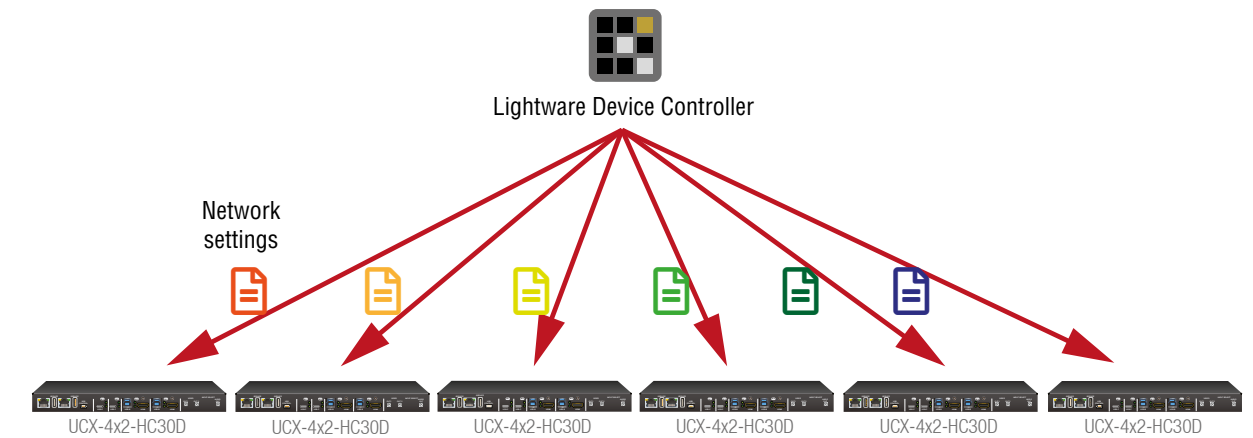

5.13.2. Device Configuration

Here you can choose the devices that need to be configured, and upload a previously saved configuration to all of them at once. This is a helpful tool for quick and easy reconfiguration of the devices after a firmware update. This function allows uploading configurations to devices with the same firmware version, without changing their network settings.

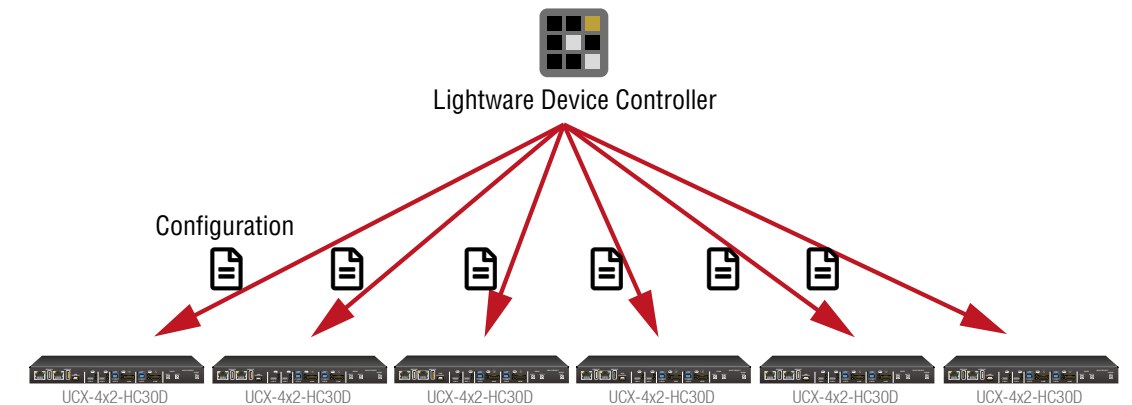

5.14. Serial Interface

Serial data communication can be established via the local RS-232 port (Phoenix connector).

Summary of Serial Ports

	UCX-2x2-H30	UCX-2x2-H40	UCX-2x1-HC30	UCX-2x1-HC40	UCX-4x2-HC30, (D)	UCX-4x2-HC40, (D)	UCX-4x3-HC40-BD	UCX-4x3-HC40	DCX-2x1-HC10	DCX-3x1-HC20
RS-232										
	2x	2x	1x	1x	2x	2x	2x	2x	-	1x

INFO: The -LCC models have the same values as non-LCC models.

5.14.1. Serial Port Diagram

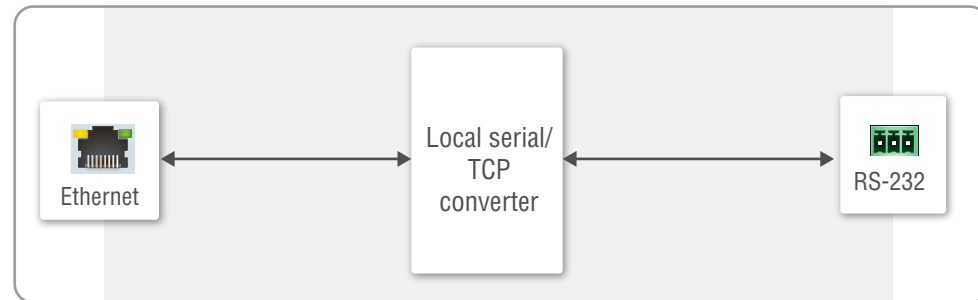

The UCX switcher works as an RS-232 bi-directional converter. The TCP signal is converted to RS-232 data and vice versa. TCP/IP port numbers are defined for serial ports (8001, 8002) for this purpose. If a command is coming from the Ethernet interface that is addressed to the port no. 8001, it will be transmitted to the Tx pin of the local RS-232 port (P1). That works in the opposite direction too, and the method is the same on the serial interface of the Ethernet port as well, but the serial message will be transmitted to all opened TCP sockets (if the TCP connection closed meanwhile, the message will not be transmitted). It can handle a maximum of 20 connections at the same time.

Disabling Serial over IP function disconnects the Serial/TCP converter from the Ethernet layer and the serial data won't be transmitted to the Ethernet network. This setting is available in the Lightware Device Controller software (in the Settings menu, [Network](#) tab) or with LW3 protocol command ([Enabling/Disabling the Network Service Port](#)).

The switcher can manage a maximum of 20 connected clients at the same time for each serial port.

Message Sending Function

Message sending function allows RS-232 command sending to a third-party (or a Lightware) device from the Taurus UCX series. Any format is acceptable (text, binary, hexadecimal, etc.), maximum message size is 100Kb. Escaping is unnecessary.

Serial message sending is possible by using HTTP Post with Lightware REST API.

- ➔ header: POST·http://<ip>/api/V1/MEDIA/SERIAL/<serial_port>/send-HTTP/1.1
- ➔ body: <message>

<serial_port> is P1 or P2.

The MP1 (CPU) is available over REST API interface. The MP1 (CPU) sends the message via the serial port to a third-party (or a Lightware) device. This is a one-way communication, the response will not be interpreted by the CPU. Consider using Serial over IP function instead of listening to a serial device.

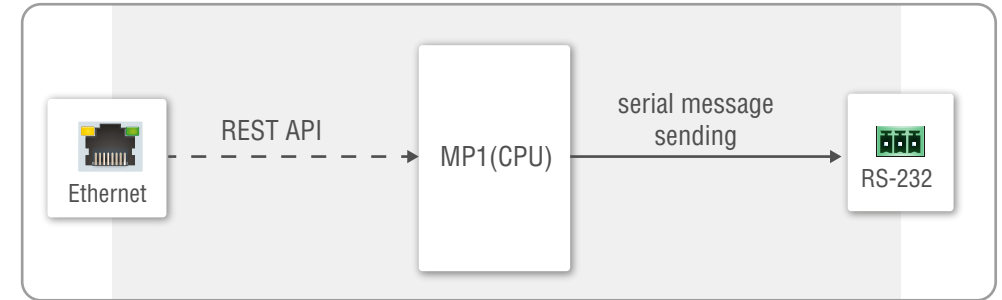

For more details about the Lightware REST API, see the [Lightware REST API Reference](#) chapter.

INFO: Taurus can receive a serial message in a special way. When a message is sent from the Taurus, the response from the connected device is accepted within 100 ms. The communication is closed after that time interval.

Serial Options - Example

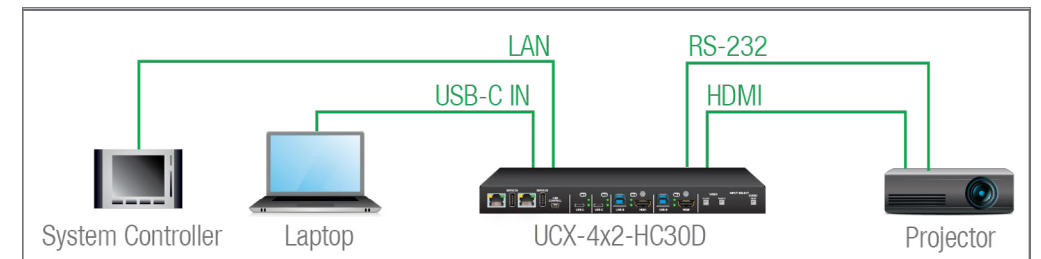

External Controller Concept

The projector is turned on and off by the external System Controller. The **System controller** has an internal REST API client, which is connected to the UCX switcher. It sends a HTTP POST to the **UCX-4x2-HC30D**. The **Switcher** sends a serial message over the P1 port to the **Projector**.

Security: When interpreting of the response from the projector is necessary, serial over IP port (8001 or 8002) can be enabled, in this case, the 8001 or 8002 ports are available from other devices too, and it makes the system unsecured.

Taurus as a Controller Concept

Userscript feature supports the automatism in UCX series devices. The Userscript can be uploaded and run in the [Settings Menu, System](#) tab in the Lightware Device Controller Software. The script packages are created by Lightware, please contact your sales representative for help.

Security: Userscript does not need Serial over IP when it sends serial messages from the UCX to the controlled device (e.g. projector) via serial port, only the secure ports remain enabled.

DIFFERENCE: UserScripts are only available with up to firmware version v1.4.4. From firmware version v1.5.0, LARA replaces functions previously managed by UserScripts.

5.15. GPIO Interface

The General Purpose Input/Output (GPIO) port is a multifunctional input/output interface to control the switcher or third-party devices and peripherals. You can establish the connection between the controller/controllable device and the switcher via the 8-pole Phoenix connector. The direction of the six pins is configurable independently from each other.

GPIO Options - Example

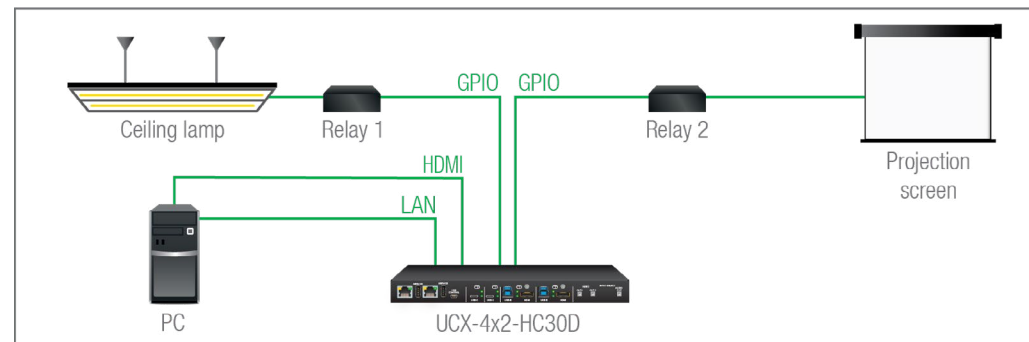

The ceiling lamp is turned off by Relay 1 and the projection screen is rolled down by Relay 2. Both relays are controlled by the GPIO port.

When the PC starts to play the video presentation, the signal is received over the HDMI input, so the GPIO pins send a signal to Relay 1 to open, which results in the lights being turned off. Furthermore, the GPIO pins also send a signal to Relay 2 to close and the projection screen is rolled down. When the presentation ends, signal ceases on the HDMI input, so the GPIO pins send a signal to Relay 1 to close, which results in the lights being turned on, and send a signal to Relay 2 to open, so the projection screen returns to its enclosure.

Userscript feature supports the automatism in UCX series devices. The Userscript can be uploaded and run in the [Settings Menu, System](#) tab in the Lightware Device Controller Software. The script packages are created by Lightware, please contact your sales representative for help.

Security: Userscript does not need to use the unsecured ports for GPIO management.

ATTENTION! Please always check the electrical parameters of the devices that you want to control. The maximum current of one GPIO pin is 30 mA, the maximum total current for the six pins is 180 mA.

DIFFERENCE: UserScripts are only available with up to firmware version v1.4.4. From firmware version v1.5.0, LARA replaces functions previously managed by UserScripts.

5.16. OCS Interface

OCS Application Example

When the occupancy sensor detects people in the meeting room, the UCX switcher turns on the ceiling lamp.

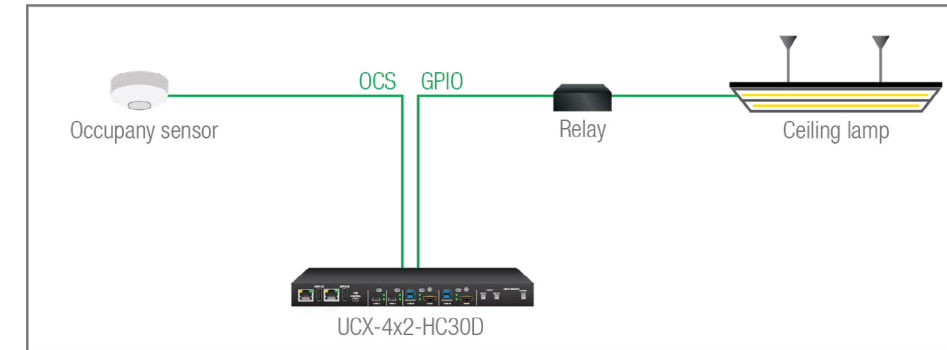

Userscript feature supports the automatism in UCX series devices. The Userscript can be uploaded and run in [Settings Menu, System](#) tab in Lightware Device Controller Software. The script packages are created by Lightware, please contact your sales representative for help.

Security: Userscript does not need to use the unsecured ports for OCS management.

DIFFERENCE: UserScripts are only available with up to firmware version v1.4.4. From firmware version v1.5.0, LARA replaces functions previously managed by UserScripts.

In case of applying Leviton OCS (<https://www.leviton.com/en/products/osc10-m0w>), supplying a 1 kOhm external resistor between the 1st and the 3rd pins is necessary.

DIFFERENCE: In case of the H(C)40 models, the external resistor is not necessary.

5.17. Further Built-in Features

5.17.1. Device Cloning – Configuration Backup and Restore



The device (configuration) cloning of UCX series switcher is a simple method that eliminates the need to repeatedly configure certain devices to have identical (non-factory) settings. If the devices are installed in the same type of system multiple times, then it is enough to set up only one device to fit the user's needs and then copy those settings to the others, thus saving time and resources.

Cloning is possible between devices using the same firmware version. All LW3 settings, WelcomeScreen Image and UserScript will be saved.

DIFFERENCE: UserScripts are only available with up to firmware version v1.4.4. From firmware version v1.5.0, LARA replaces functions previously managed by UserScripts.

Please note that the clone file can be downloaded and uploaded via HTTP or HTTPS, so 80 or 433 port has to be enabled.

See more information about the settings in the [Clone configuration](#) section.

6

Software Control Options

Taurus device allows setting all the parameters via a user-friendly interface. Open a web browser (Google Chrome or Mozilla Firefox is highly recommended) and connect to the device to access the parameters and settings. The other option is to use the Lightware Device Controller (LDC) software and connect to the device without a web browser. The features are described in the coming sections.

- ▶ [SOFTWARE CONTROL MODES](#)
- ▶ [USING THE BUILT-IN WEB](#)
- ▶ [INSTALL AND UPDATE THE LDC](#)
- ▶ [RUNNING THE LDC](#)
- ▶ [ESTABLISHING THE CONNECTION](#)
- ▶ [BULK DEVICE MANAGEMENT](#)
- ▶ [LDC LAYOUT](#)
- ▶ [VIDEO & AUDIO CROSSPOINT](#)
- ▶ [PORT PROPERTIES WINDOW](#)
- ▶ [CEC TOOL](#)
- ▶ [USB CROSSPOINT](#)
- ▶ [EDID MENU](#)
- ▶ [CONTROL MENU](#)
- ▶ [SETTINGS MENU](#)
- ▶ [ADVANCED VIEW WINDOW](#)

6.1. Software Control Modes

The device can be controlled in the following ways:

- Using the **built-in web page**,
- Using the **Lightware Device Controller (LDC)** software,
- Sending **REST API commands** (see the [Lightware REST API Reference](#) chapter), or
- Sending **LW3 commands** (see the [LW3 Programmers' Reference](#) chapter).

DIFFERENCE: The built-in webpage is available from firmware package v1.4.0b4.

Built-in web page vs. LDC

The LDC and the built-in web page shows the same content, but there are some minor differences:

Function	Built-in Web	LDC
Platform	A Web browser running under Windows, macOS or Android	Windows, mac OS
Installation	Web browser needed only	Required
Device discovery	-	✓

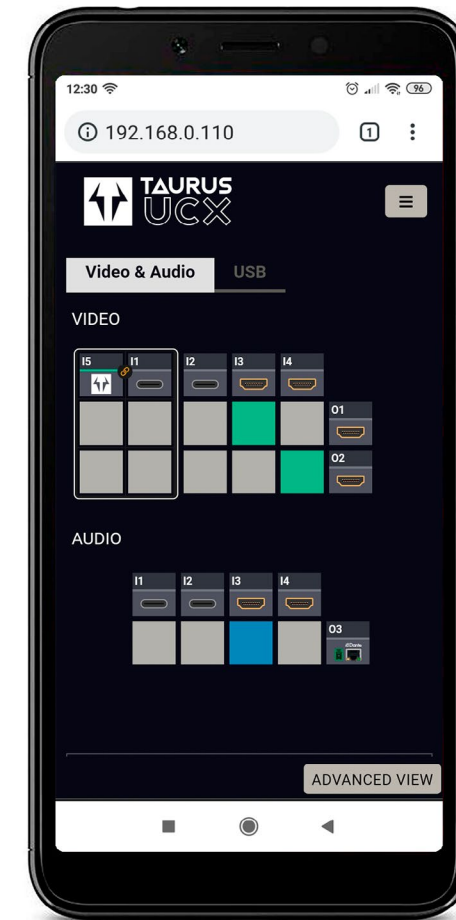

The Main Window - Displayed on a Smartphone

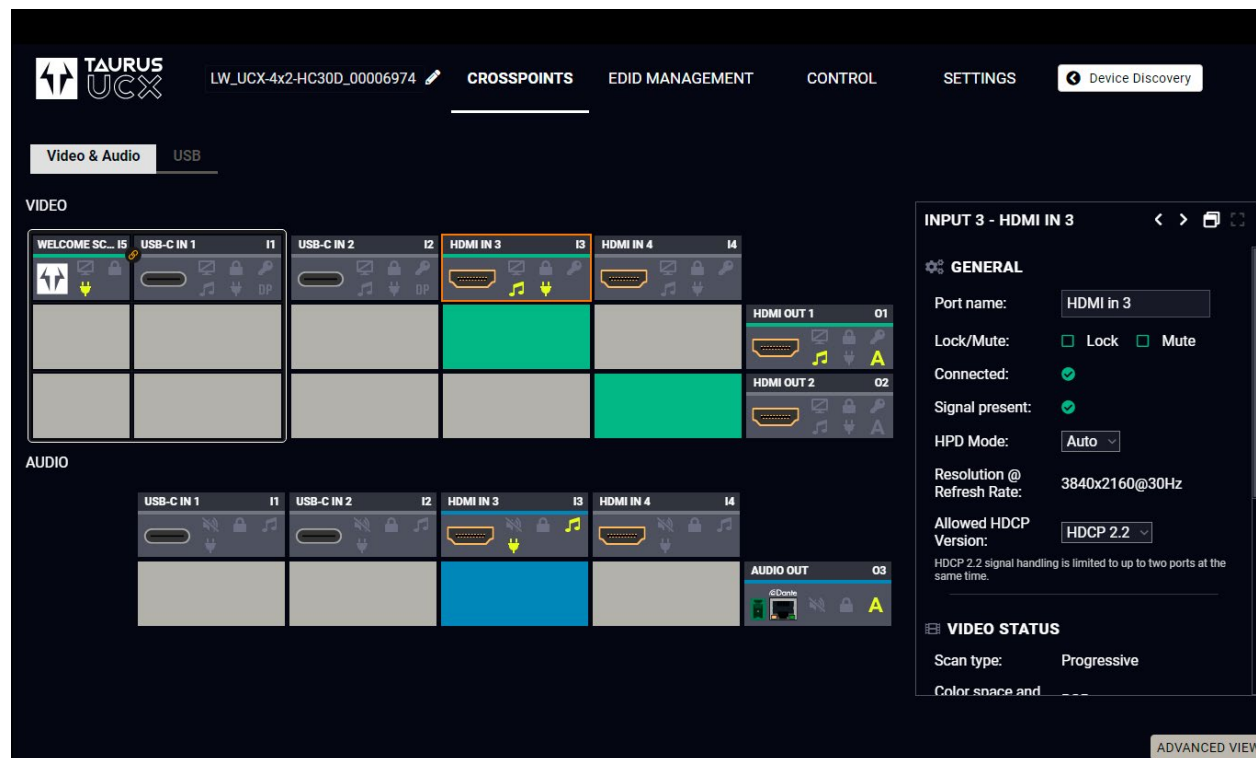

The Main window – Displayed in LDC

6.2. Using the Built-in Web

UCX devices can easily be controlled and configured without downloading and installing LDC, by utilizing the built-in web.

Connecting to the device is possible by typing its IP address into the URL of the browser.

The layout of the built-in web is generally the same as the LDC, with a few differences:

- There is no **Device Discovery** button.
- From FW version v2.9.0, there is a **Logout** button.

INFO: The **Logout** button will only appear if the device has a password and the user is logged in.

DIFFERENCE: From FW version v2.9.0, the maximum length of a single session is **120 minutes**. If this time is up, you will be logged out, and the device will only be available upon logging in again.

DIFFERENCE: From FW version v2.9.0, in case of **30 minutes** of inactivity the session will expire. The system will remind you in a pop-up window if the current session is about to expire five minutes before the time limit. If the reminder receives no answer, the session will restart and you will be forced to log out.

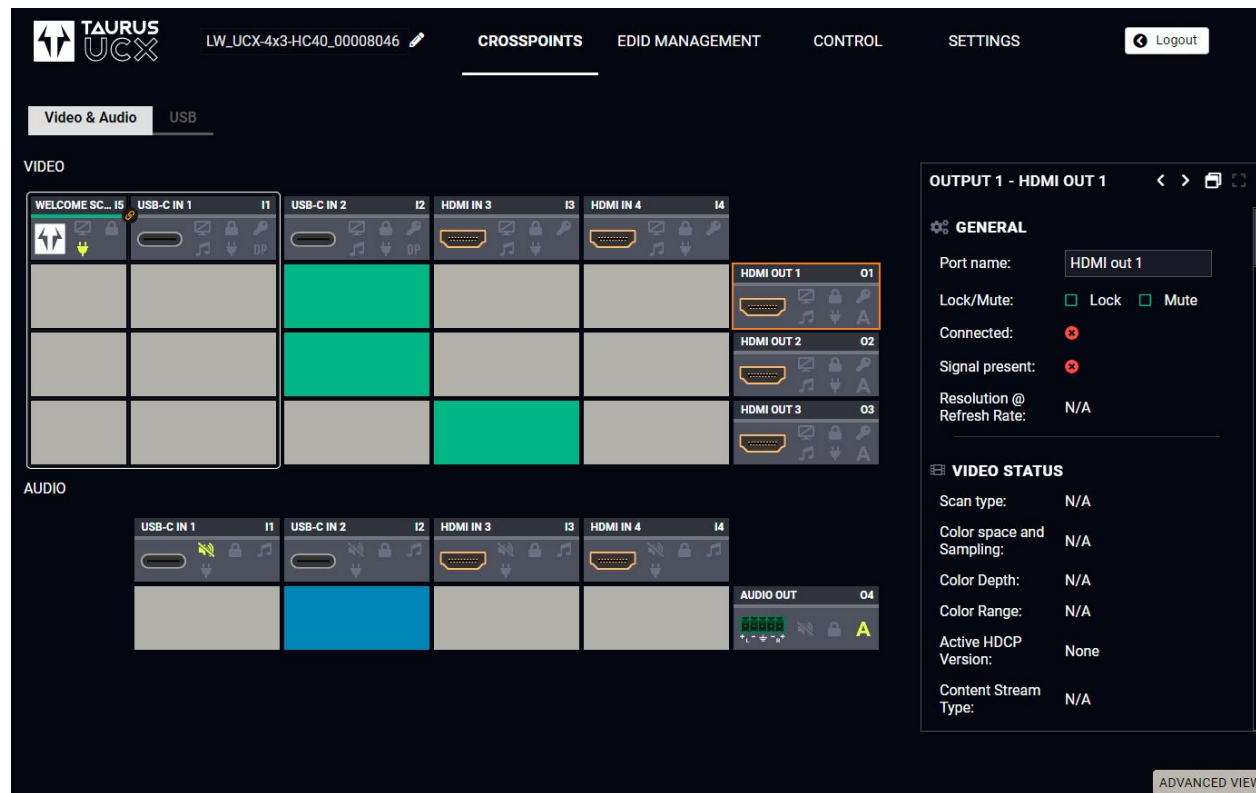

The Logout button appears in the upper right corner upon login

6.3. Install and Update the LDC

INFO: After the installation, the Windows and the Mac applications have the same look and functionality. This type of the installer is equal with the Normal install in case of Windows and results in an updatable version with the same attributes.

Installation for Windows OS

Run the installer. If the User Account Control drops a pop-up message, click **Yes**.

During the installation you will be prompted to select the type of the installation: **normal** and the **snapshot** install:

Normal install	Snapshot install
Available for Windows and macOS	Available for Windows
The installer can update only this instance	Cannot be updated
Only one updatable instance can exist for all users	More than one different version can be installed for all users

Comparison of installation types

ATTENTION! Using the Normal install as the default choice is highly recommended.

Installation for macOS

Mount the DMG file by double clicking on it, and drag the LDC icon over the Applications icon to copy the program into the Applications folder. If you want to copy the LDC into another location, just drag the icon over the desired folder.

Updating of LDC

Step 1. Run the application.

The **Device Discovery** window appears automatically, and the program checks the available updates on Lightware's website and opens the update window if LDC updates are found.

The current and the update version numbers can be seen at the top of the window and they are shown in this window even with the snapshot install.

The **Update** window can also be opened by clicking on the **About icon** and the **Update** button.

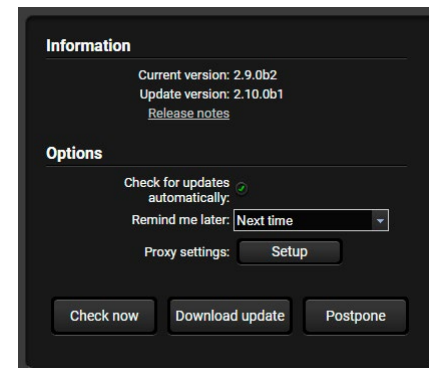

Step 2. Set the desired update setting in the **Options** section.

- If you do not want to check for the updates automatically, uncheck **the circle** that contains the green tick.
- If you want to postpone the update, a reminder can be set with different delays from the **drop down list**.
- If the proxy settings traverse the update process, set the proper values, then click on the **OK** button.

Step 3. Click on the **Download update** button to start the updating.

The updates can be checked manually by clicking on the **Check now** button.

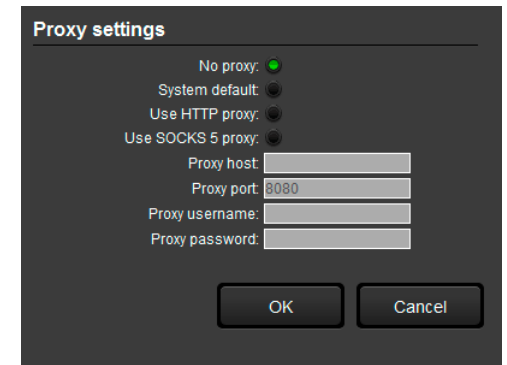

6.4. Running the LDC

The common way to start the software is to double-click on the LDC icon. But the LDC can be run by command line parameters as follows:

Connecting to a Device with Static IP Address

The LDC is connected to a device with the indicated static IP address directly; the Device Discovery window is not displayed. When the port number is not set, the default port is used: 6107 (LW3 protocol).

Format: LightwareDeviceController -i <IP_address>:<port>

Example: LightwareDeviceController -i 192.168.0.20:6107

Adjusting the Zoom

The window can be zoomed to a specific value to fit to the resolution of the desktop (higher/lower). '1' is the default value (100%).

Format: LightwareDeviceController -z <magnifying_value>

Example: LightwareDeviceController -z 1.2

ATTENTION! The last set value is stored and applied when LDC is started without a parameter.

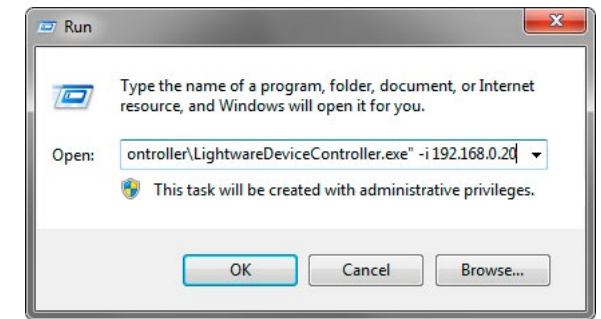

6.5. Establishing the Connection

Step 1. Connect the device to a computer via Ethernet.

Step 2. Run the controller software; device discovery window appears automatically.

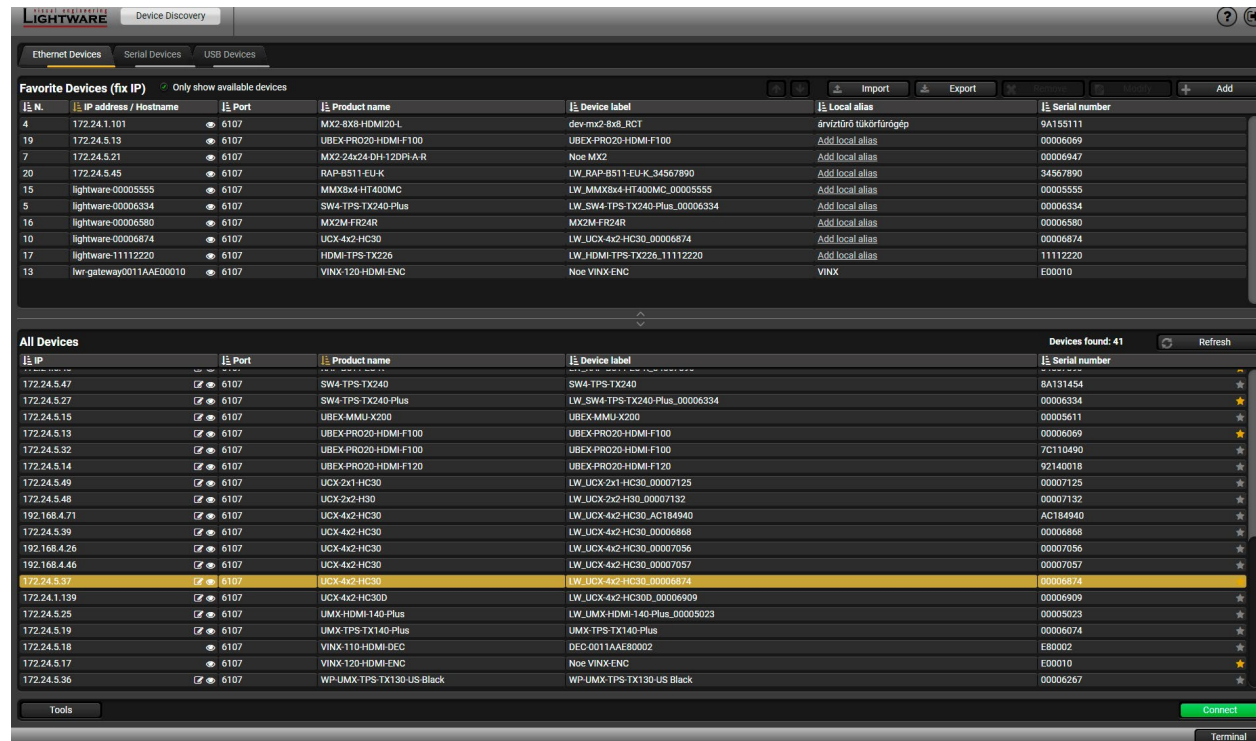

Device discovery window in LDC

The Ethernet tab consists of two lists. **All devices** list contains all Lightware devices that are available in the connected network (in the 255.255.0.0 subnet). However, there is no need to browse all the available devices as you can expand the list of **Favorite devices** with any Lightware device that is connected via Ethernet by any of the following ways:

- Mark the desired device with the ★ symbol in the **All Devices** list,
- Press the **Add** button and add the device in the appearing window, or
- Import** the list of favorite devices that was **exported** previously.

When both the 6107 and 80 ports are disabled, only the secure 443 port remains open, the UCX switcher appears in the all devices list with 443 port.

Double click on the device offers an option to open the other ports (80 and 6107) and use e.g. Lightware Device Controller software.

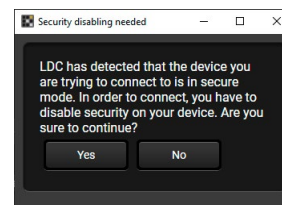

Add New Favorite Device

DIFFERENCE: This feature is available only from v2.5.5 LDC version.

Press the **Add** button; in the appearing window you can enter the **IP address**. The **hostname** of the desired device can be used instead, if it is supported. That allows setting a unique name to identify the device in a network. If the host name is saved in this window and the IP address is changing, the device will still be available and connectible.

ATTENTION! The host name connection-feature does not work when the target device is accessed over VPN.

See more information about the host name property in the [Setting the Host Name](#) section.



Import/Export the List of Favorite Devices

DIFFERENCE: This feature is available only from v2.5.5 LDC version.

The list of favorite devices can be exported/imported by the dedicated buttons (saved as *.JSON file). The list can be imported later (in another computer, too), but please note that the current list will be overwritten by the imported list.

Changing the IP Address



To modify the IP address settings quickly, it is not necessary to enter the device's settings/network menu, you can set them by clicking the pencil icon beside the IP address.

You can see the new settings only in this window. The device needs a few seconds to apply the new settings. `#ipaddress`

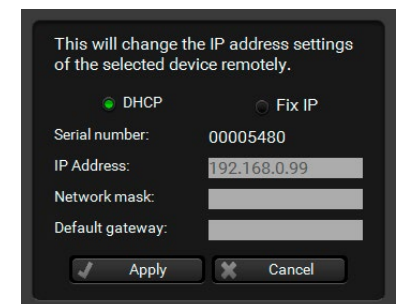

Identifying the Device



DIFFERENCE: This feature is available only from v1.2.0 firmware version.

Clicking on the icon results in the blinking of the status LEDs for 10 seconds. The feature helps to find the device itself physically.

6.6. Bulk Device Management

It is possible to configure several devices at once with the Bulk Device Management tool. This feature can be accessed by clicking on the Tools button in the bottom left corner of the Device Discovery window and choosing the Bulk Management option.

DIFFERENCE: This function is available from the firmware version v2.6.0b6 of the LDC and v1.3.1b1 of the Taurus UCX devices.

6.6.1. Network Settings

It is possible to set the network settings of several devices at once by using a .csv file that contains the list of the devices that we need to configure, then uploading it into the LDC.

Please note that if the data in the file is missing or incorrect, then the discovery of the affected device will fail and an 'Invalid data' message will be displayed in the State column. In case of an IP or MAC address conflict, the message is 'Duplicated'.

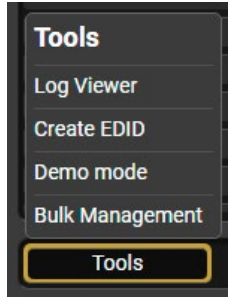

Discovered	MAC Address	Part Number	DHCP	IP Address	Netmask	Gateway	Host Name	Device Label	State
✓	a8:d2:36:ff:50:23	91560003	DISABLED	192.168.0.111	255.255.255.0	192.168.0.1		LW_UMX-HDMI-140-Plus_00005023	Invalid Data
✓	a8:d2:36:00:55:60	91310042	ENABLED	192.168.0.116	N/A	N/A	MMX8x4	LW_MMX8x4-HT420M_00005560	All Done
✓	a8:d2:36:ff:38:59	91540059	DISABLED	192.168.0.121	255.255.255.0	192.168.0.1	lightware-00003859	UMX-TPS-TX140-kicsirizs	Partly Done
✓	a8:d2:36:ff:44:29	91310034	ENABLED	192.168.0.121	N/A	N/A	lightware-00004429	MMX4x2-HDMI	Duplicated
✓	a8:d2:36:ff:22:63	91540065	ENABLED	192.168.0.117	N/A	N/A	lightware-00002263	LW_SW4-TPS-TX240-Plus_00002263	All Done
✓	a8:d2:36:ff:99:99	91540021	ENABLED	192.168.0.122	N/A	N/A	lightware-99999999	LW_HDMI-TPS-RX110AY_00005909	All Done
✓	a8:d2:36:f0:69:74	91310082	ENABLED	192.168.0.112	N/A	N/A	lightware-00006974	LW_UCX-4x2-HC30D_00006974	All Done
✓	a8:d2:36:f0:73:16	91310078	ENABLED	192.168.0.115	N/A	N/A	lightware-00007316	LW_MMX2-4x3-H20_00007316	All Done
✓	a8:d2:36:ff:66:02	91310075	ENABLED	192.168.0.127	N/A	N/A	mtg-room1	MMX8x8_USB	All Done

MACADDRESS	PARTNUMBER	DHCP	IP	NETMASK	GATEWAY	HOSTNAME	DEVICELABEL
a8:d2:36:ff:50:23	91560003	DISABLED	192.168.0.111	255.255.255.0	192.168.0.1	lightware-00005023	LW_UMX-HDMI-140-Plus_00005023
a8:d2:36:00:55:60	91310042	ENABLED	192.168.0.116	255.255.255.0	192.168.0.1	MMX8x4	LW_MMX8x4-HT420M_00005560
a8:d2:36:ff:38:59	91540059	DISABLED	192.168.0.121	255.255.255.0	192.168.0.1	lightware-00003859	UMX-TPS-TX140-kicsirizs
a8:d2:36:ff:44:29	91310034	ENABLED	192.168.0.120	255.255.255.0	192.168.0.1	lightware-00004429	MMX4x2-HDMI
a8:d2:36:ff:22:63	91540065	ENABLED	192.168.0.117	255.255.255.0	192.168.0.1	lightware-00002263	LW_SW4-TPS-TX240-Plus_00002263
a8:d2:36:ff:99:99	91540021	ENABLED	192.168.0.122	255.255.255.0	192.168.0.1	lightware-99999999	LW_HDMI-TPS-RX110AY_00005909
a8:d2:36:f0:69:74	91310082	ENABLED	192.168.0.112	255.255.255.0	192.168.0.1	lightware-00006974	LW_UCX-4x2-HC30D_00006974
a8:d2:36:f0:73:16	91310078	ENABLED	192.168.0.115	255.255.255.0	192.168.0.1	lightware-00007316	LW_MMX2-4x3-H20_00007316
a8:d2:36:ff:66:02	91310075	ENABLED	192.168.0.127	255.255.255.0	192.168.0.1	mtg-room1	MMX8x8_USB

Changing the network settings can be done in a few easy steps:

- Step 1.** First alter the settings you need to change in the .csv file that contains the devices. You can use a template file accessible via the **Export template** button and saving the file to your computer, then filling it out with the parameters of the devices. The file contains the MAC address, Partnumber, DHCP status, IP address, Netmask, Gateway, Hostname and Device label of each device.
- Step 2.** Upload the .csv file into the LDC by pressing the **Choose network file** button and browsing the file in the pop-up window. This will result in a list of the devices appearing on the screen.
- Step 3.** Finally, press the **Apply settings** button to execute the changes. This might take up to a minute to finish.

Message	DHCP enabled	DHCP disabled	Device discovered
✓ All Done	Successful procedure		✓
✗ Partly Done	Failure setting the Host name and/or the Device label		✗
Unavailable device	Host name and Device label missing	IP address, Network, and/or Gateway missing	✗
Failed	Host name and Device label incorrect	IP address, Network and Gateway incorrect	✓
IP mismatch	-	Host name and Device label incorrect	✗

ATTENTION! The 'Failed' and 'IP mismatch' status indicators are not common, they appear when the multicast and/or the port used for LMDMP connection is disabled, or if the firmware version of the device is below the recommended (see the pop-up window when opening the Bulk Management or the beginning of this chapter).

6.6.2. Device Configuration

DIFFERENCE: From v2.6.4 LDC version it is possible to upload configurations to devices protected by a password as well.

Here you can choose the devices that need to be configured and upload a previously saved configuration to all of them at once. This is a helpful tool for quick and easy reconfiguration of the devices after a firmware update. This function allows uploading configurations to devices with the same firmware version, without changing their network settings.

MAC Address	Part Number	DHCP	IP Address	Host Name	Device Label	State
a8:d2:36:ff:50:23	91560003	DISABLED	192.168.0.111	lightware-00005023	LW_UMX-HDMI-140-Plus_0...	Unsupported Device
a8:d2:36:00:55:60	91310042	ENABLED	192.168.0.116	MMX8x4	LW_MMX8x4-HT420M_000...	Unsupported Device
a8:d2:36:ff:38:59	91540059	DISABLED	192.168.0.121	lightware-00003859	UMX-TPS-TX140-kicsirizs	Unsupported Device
a8:d2:36:ff:44:29	91310034	ENABLED	192.168.0.120	lightware-00004429	MMX4x2-HDMI	Unsupported Device
a8:d2:36:ff:22:63	91540065	ENABLED	192.168.0.117	lightware-00002263	LW_SW4-TPS-TX240-Plus_...	Unsupported Device
a8:d2:36:ff:99:99	91540021	ENABLED	192.168.0.122	lightware-99999999	LW_HDMI-TPS-RX110AY_0...	Unsupported Device
a8:d2:36:f0:69:74	91310082	ENABLED	192.168.0.112	lightware-00006974	LW_UCX-4x2-HC30D_0000...	
a8:d2:36:f0:73:16	91310078	ENABLED	192.168.0.115	lightware-00007316	LW_MMX2-4x3-H20_00007...	
a8:d2:36:ff:66:02	91310075	ENABLED	192.168.0.127	mtg-room1	MMX8x8_USB	Unsupported Device
a8:d2:36:f0:69:42	91310082	ENABLED	192.168.0.125	lightware-00006942	LW_UCX-4x2-HC30D_0000...	IP mismatch!
a8:d2:36:f0:33:16	91310078	ENABLED	192.168.0.110	lightware-00003316	LW_MMX2-4x3-H20_00003...	Duplicated
a8:d2:36:f0:71:03	91310078	ENABLED	192.168.0.110	lightware-00007103	LW_MMX2-4x3-H20_00007...	DEVICELABEL mismatch!
a8:d2:36:f0:73:13	91310081	ENABLED	192.168.4.33	lightware-C3257074	LW_UCX-4x2-H30_C325707...	HOSTNAME mismatch! DE...
	91310081	ENABLED	192.168.5.76	lightware-C3258910	LW_UCX-4x2-HC30_C3258...	Invalid Data

Please note that if the data in the .csv file is missing or incorrect, then the discovery of the affected device will fail and an 'Invalid data' message will be displayed in the State column. In case of an IP or MAC address conflict, the message is 'Duplicated', or if the IP address is incorrect, 'IP mismatch!'. 'Hostname mismatch!' or 'Device label mismatch!' appears if the respective values are incorrect.

Changing the configuration of the devices can be done in a few easy steps.

- Step 1.** Set the desired configurations in one of the devices, then clone your configuration in the **Settings** menu, under the **System** tab. Click on the **Download clone file** button in the right, set the file name in the pop-up window and press **Save**. Please note that this file is not available for offline editing.
- Step 2.** Go back to the Device Discovery screen of the LDC, click on the **Tools** button in the bottom left corner and select the **Bulk Management** option.
- Step 3.** Select the Device Configuration tab, then press the black **Device discovery** button for the LDC to list all compatible devices, or upload a device list that has been created beforehand. For such a file, you can use a template by clicking on the **Export template** button and saving it to your computer, see in the previous section. You can upload this file into the LDC by clicking on the **Upload device list** button, browsing the desired file and pressing the **Open** button.

- Step 4.** Once uploaded, you can further select devices from the list to be configured or you can change settings in all of them by ticking the box next to the head of the list.
- Step 5.** To change the configuration of the devices, you need to upload a configuration file previously saved from a device with the same firmware version via the **Upload config file** button. Browse the file in the pop-up window and press **Open**.
- Step 6.** In order to upload a configuration to a device that has authentication, it is necessary to fill out the credentials. This can be done via the **Credential Details** button (key icon in case of a smaller window). LDC will attempt uploading the configuration over HTTPS first, if that fails, it will attempt it over HTTP.
- Step 7.** Click on the **Apply settings** button in the lower right corner to start the reconfiguration procedure.

MAC Address	Part Number	DHCP	IP Address	Host Name	Device Label	State
a8:d2:36:ff:50:23	91560003	DISABLED	192.168.0.111	lightware-00005023	LW_UMX-HDMI-140-Plus_0...	Unsupported Device
a8:d2:36:00:55:60	91310042	ENABLED	192.168.0.116	MMX8x4	LW_MMX8x4-HT420M_000...	Unsupported Device
a8:d2:36:ff:38:59	91540059	DISABLED	192.168.0.121	lightware-00003859	UMX-TPS-TX140-kicsirizs	Unsupported Device
a8:d2:36:ff:44:29	91310034	ENABLED	192.168.0.120	lightware-00004429	MMX4x2-HDMI	Unsupported Device
a8:d2:36:ff:22:63	91540065	ENABLED	192.168.0.117	lightware-00002263	LW_SW4-TPS-TX240-Plus_...	Unsupported Device
a8:d2:36:ff:99:99	91540021	ENABLED	192.168.0.122	lightware-99999999	LW_HDMI-TPS-RX110AY_0...	Unsupported Device
a8:d2:36:f0:69:74	91310082	ENABLED	192.168.0.112	lightware-00006974	LW_UCX-4x2-HC30D_0000...	Firmware version mis...
a8:d2:36:f0:73:16	91310078	ENABLED	192.168.0.115	lightware-00007316	LW_MMX2-4x3-H20_00007...	Configuration saved su...
a8:d2:36:ff:66:02	91310075	ENABLED	192.168.0.127	mtg-room1	MMX8x8_USB	Unsupported Device
a8:d2:36:f0:69:42	91310082	ENABLED	192.168.0.123	lightware-00006942	LW_UCX-4x2-HC30D_0000...	HTTPS: Configuration sa
a8:d2:36:f0:33:16	91310078	ENABLED	192.168.0.110	lightware-00003316	LW_MMX2-4x3-H20_00003...	Duplicated
a8:d2:36:f0:71:03	91310078	ENABLED	192.168.0.110	lightware-00007103	LW_MMX2-4x3-H20_00007...	DEVICELABEL mismatch!
a8:d2:36:f0:73:13	91310081	ENABLED	192.168.4.33	lightware-C3257074	LW_UCX-4x2-H30_C325707...	HOSTNAME mismatch! DE...
	91310081	ENABLED	192.168.5.76	lightware-C3258910	LW_UCX-4x2-HC30_C3258...	Invalid Data

The list will be updated when the configuration procedure is finished, where in case of success, the **Configuration saved successfully** message will be displayed in the State column.

Please note that a configuration can only be applied to a device with the same firmware version, otherwise the **Firmware version mismatch** error message will appear under the State column.

If the configuration is applied to a different variant, the **Variant mismatch** error message will appear.

If the network settings are incorrect, applying the configuration will fail, and the message **Incorrect network settings** will appear under the State column.

For more details about saving a configuration, see the [Clone configuration](#) section.

If a device that is in the list is not connected to the network or its IP address is incorrect, the software will fail to detect it, and will display a **Failed to fetch** message in the State column when applying settings.

6.7. LDC Layout

ATTENTION! Up to the v1.0.1b1 firmware version and v2.5.3b3 LDC version, the older LDC layout can be seen. From the v1.1.0b7 firmware version and v2.5.4b3 LDC the LDC design changed as it is seen in this chapter.

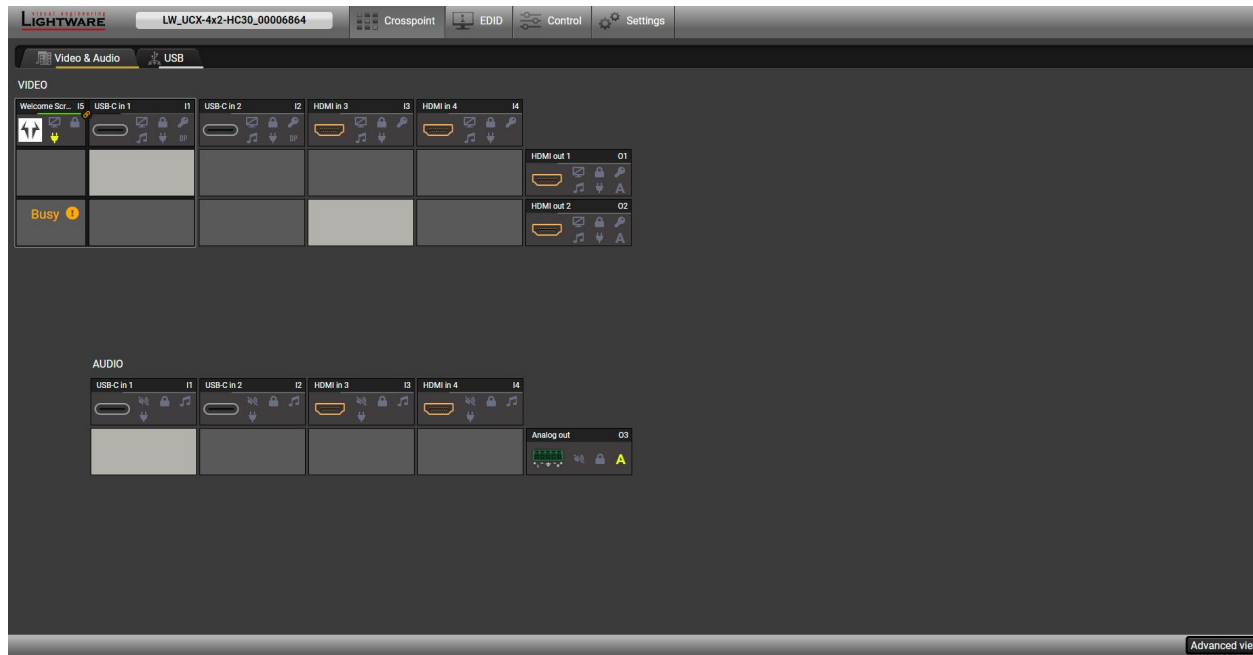

LDC design up to v2.5.3b3 LDC and v1.0.1b1 firmware

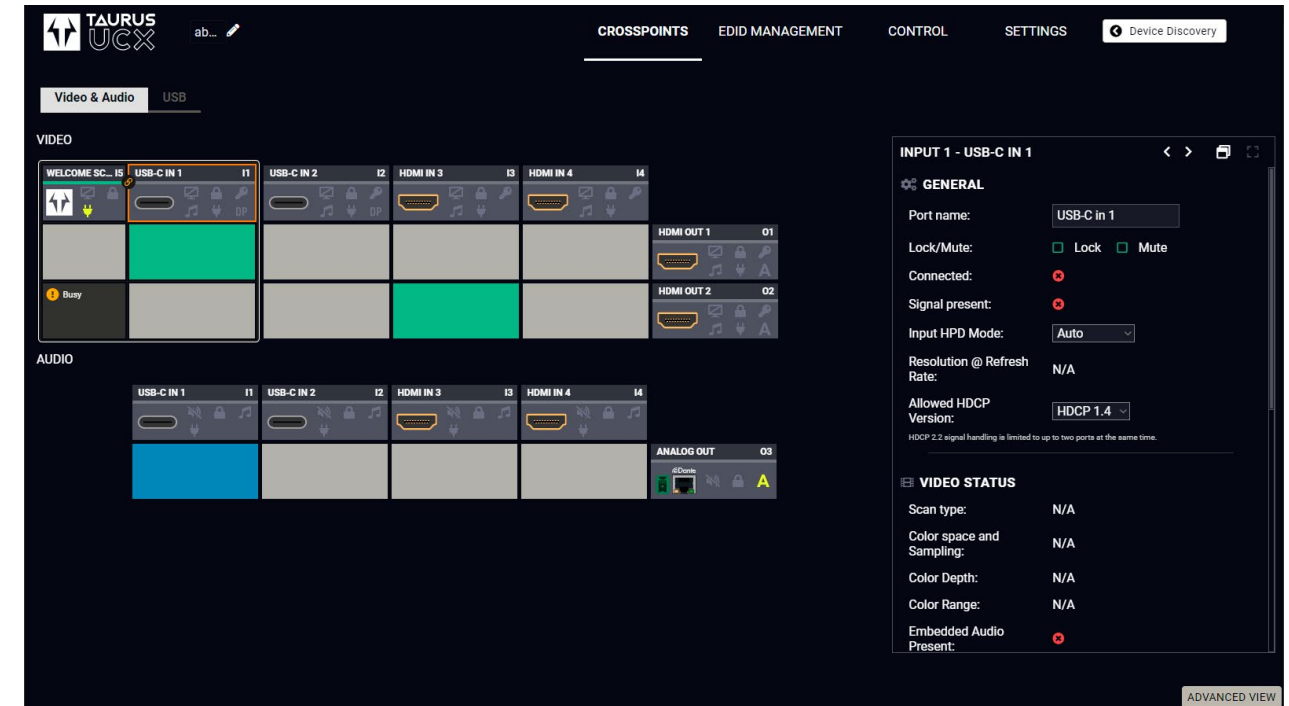

LDC design above v2.5.4b3 LDC and v 1.1.0b7 firmware

6.8. Video & Audio Crosspoint

#crosspoint #switch

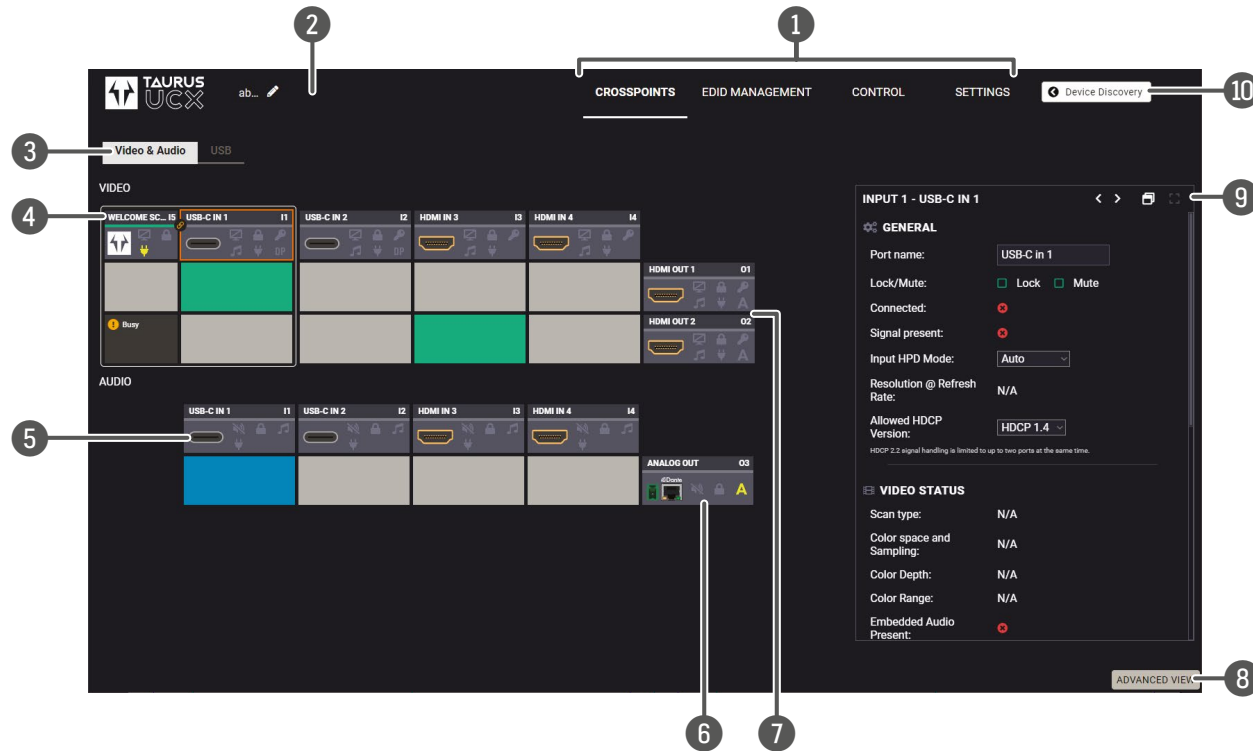

- 1 **Main menu** The available menu items are displayed. The active one is shown with dark grey background color.
- 2 **Information ribbon** The label shows the device label, which can be edited in the Settings menu - [Status](#) tab.
- 3 **Submenu selector** The audio and video crosspoint menu and the USB crosspoint menu are available under the two tabs.
- 4 **Video input ports** Each tile represents a video input port: [Welcome Screen](#), [USB-C Inputs](#), [HDMI Video Inputs](#). The tile below the port shows the current crosspoint setting; if the port is switched to the output, the color of the tile is green, otherwise grey. Clicking on the tile opens the input properties window.
- 5 **Audio input ports** Each tile represents an audio input port. All of them are logical audio ports, they mean the de-embedded audio channel of the selected USB-C/HDMI inputs. For more details, see [Embedded Audio Input](#).
- 6 **Audio output port** Analog audio output port; clicking on the O3 tile opens the [Analog Audio Output](#) window. The de-embedded audio is mirrored to the Dante Audio Output in case of UCX-4x2-HC30D and UCX-4x2-HC40D.
- 7 **Video output ports** HDMI video output ports; clicking on the tile opens the [HDMI Video Output](#) port properties window.
- 8 **Advanced view** Displaying the [Advanced View Window](#), showing the Terminal window and the LW3 protocol tree.
- 9 **Properties window** Settings and status information of the selected panel are displayed in this section. Clicking on the icon  opens the properties section in a new window.
- 10 **Navigation button** The device discovery window can be displayed by clicking on this button.

ATTENTION! Video crosspoint has a limitation: I1 and I5 ports are not available at the same time, only one of them can be selected to any output. The **Busy** label on the crosspoint tile refers to the limitation. When I5 is selected for the video source, the de-embedded audio of the I1 is not available because of the video crosspoint limitation. For more details about it, see the port diagram in the [Audio Interface](#) section.

TIPS AND TRICKS: Hover the mouse cursor over the information ribbon; the **device label** and the **IP address** of the device will appear as a tooltip text.

6.8.1. Port Tiles

The colors of the port tiles and the displayed icons represent different states and information:

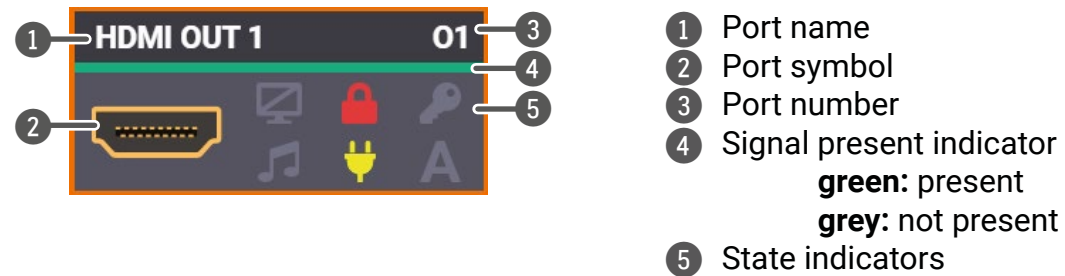

State Indicators #lock #unlock #mute #unmute

The following icons display different states of the port/signal:

Icon is grey	Description	Icon is highlighted	Description
	Port is unmuted		Port is muted
	Port is unlocked		Port is locked
	Signal is not encrypted with HDCP		Signal is encrypted with HDCP (the HDCP version is displayed)
	Embedded audio is not present		Embedded audio is present
	There is no connected device		The device is connected
DP	No USB Host connected or DP Alt mode is not supported by USB Host		DP Alternate mode successfully entered
			Unable to enter DP Alternate mode
	Autoselect is disabled		Autoselect is enabled
	Audio is unmuted		Audio is muted
	Charging function is inactive		Charges the connected device

6.9. Port Properties Window

Clicking on the port tile opens the Port properties window. This section shows the available settings and status information by port types. #lock #unlock #mute #unmute

6.9.1. Welcome Screen

Welcome screen is an internal source, which can be customized – see more information in the [Welcome Screen](#) section. #welcomescreen

ATTENTION! Video crosspoint has a limitation: I1 and I5 ports are not available at the same time, only one of them can be selected to any output. The **Busy** label on the crosspoint tile refers to the limitation.

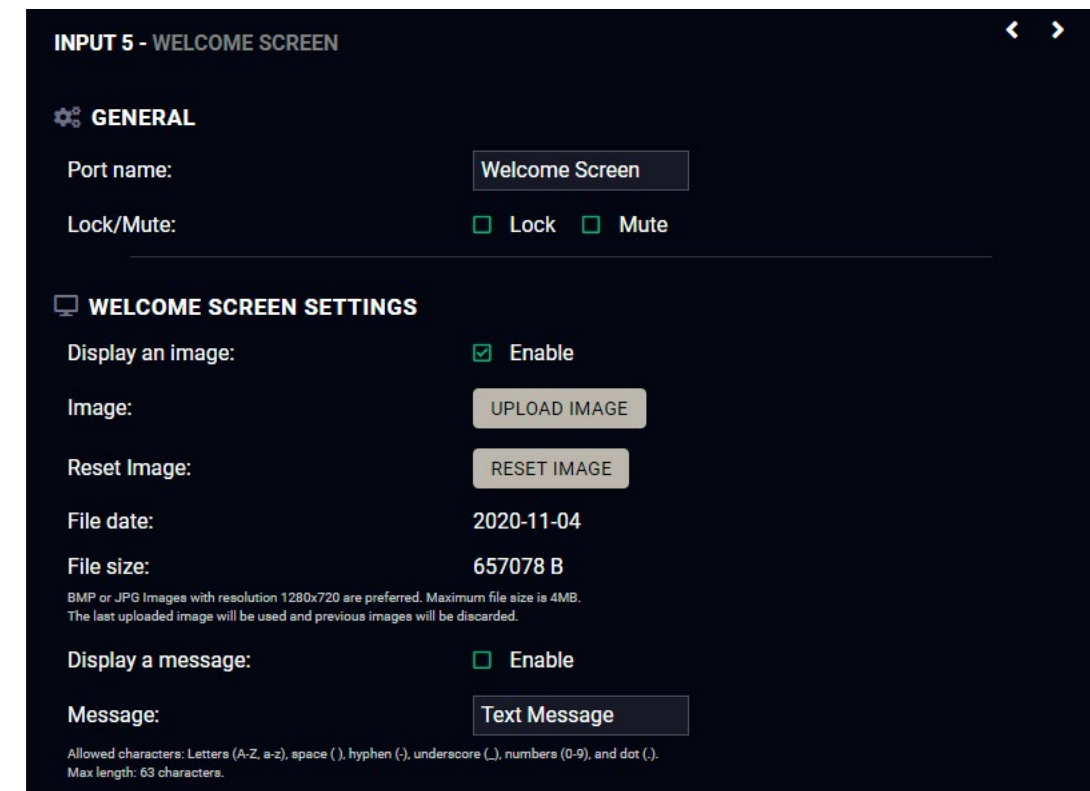

General

Port name

The name of a port can be changed by typing the new name and clicking on the **Set** button. The following characters are allowed when naming: Letters (A-Z) and (a-z), hyphen (-), underscore (_), numbers (0-9), and dot (.). Max length: 63 characters.

Lock *#lock #unlock*

The port can be locked to the currently connected output ports by adding a tick. If the port is locked, the crosspoint state of this port cannot be changed.

Mute *#mute #unmute*

The port can be muted/unmuted by adding/removing a tick. If the port is muted, no signal is transmitted from the input port.

Welcome Screen Settings

Display Welcome Screen Image

Add a tick to **Display Welcome Screen Image** to enable the appearance of the internal image.

Upload Image

Click on the **Upload Image** button to browse jpg or bmp file to customize the welcome screen picture. Recommended resolution: 1280x720 pixel, maximum file size is 4MB.

ATTENTION! Uploading a new image will overwrite the previous one.

Reset Image

Clicking on the **reset image** button restores the factory default state.

Display Welcome Screen Message

Add a tick to **Display Welcome Screen Message** to enable the appearance of the text message.

Welcome Screen Message

The following characters are allowed: Letters (A-Z) and (a-z), hyphen (-), underscore (_), numbers (0-9), space () and dot (.). Max length: 63 characters.

6.9.2. USB-C Inputs

Clicking on the USB-C video input port icon opens the Port properties window. The most important information and settings are available from the panel.

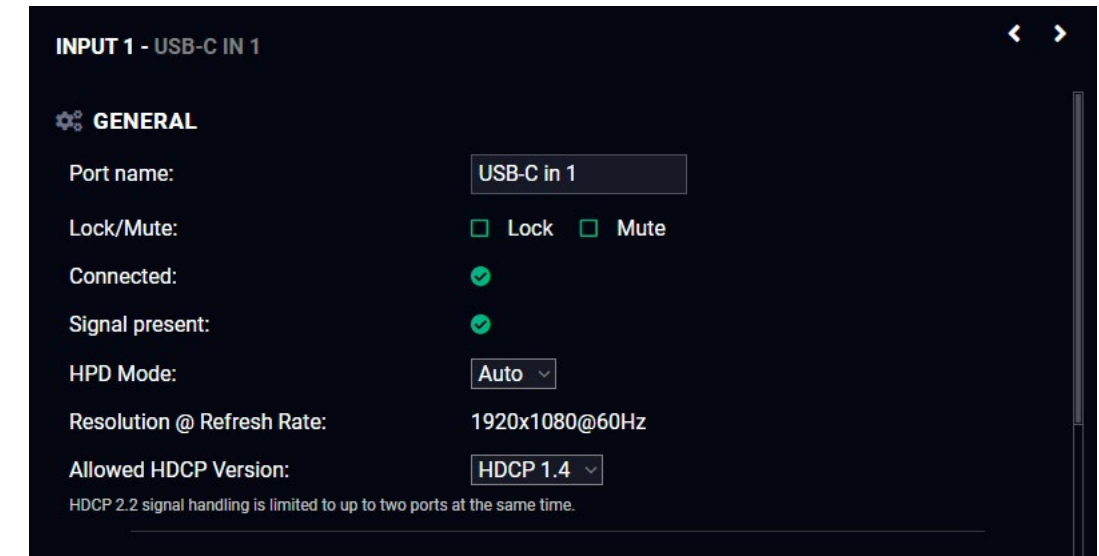

USB-C input port properties window

General

Port name

The name of a port can be changed by typing the new name and clicking on the **Set** button. The following characters are allowed when naming: Letters (A-Z) and (a-z), hyphen (-), underscore (_), numbers (0-9), and dot (.). Max length: 63 characters.

Lock *#lock #unlock*

The port can be locked to the currently connected output ports by adding a tick. If the port is locked, the crosspoint state of this port cannot be changed.

Mute *#mute #unmute*

The incoming signal can be muted/unmuted by adding a tick. If the port is muted, no signal is transmitted from the input port.

HPD Mode

Hot Plug Detection function can be set here. Using Auto mode is highly recommended.

Status information

Connected / Signal Presence / Resolution

Allowed HDCP Version `#hdcv`

ATTENTION! HDCP 2.2 signal handling is limited to up to two input ports at the same time.

- **Off:** The connected source will detect that the switcher is not HDCP-compliant and turn off authentication if the content allows it.
- **HDCP 1.4:** The connected source will detect that the switcher is compliant with HDCP 1.4, but not compliant with HDCP 2.2.
- **HDCP 2.2:** The connected source will detect that the switcher is compliant with HDCP 2.2.

Video Status

This section gives a feedback about the current video stream:

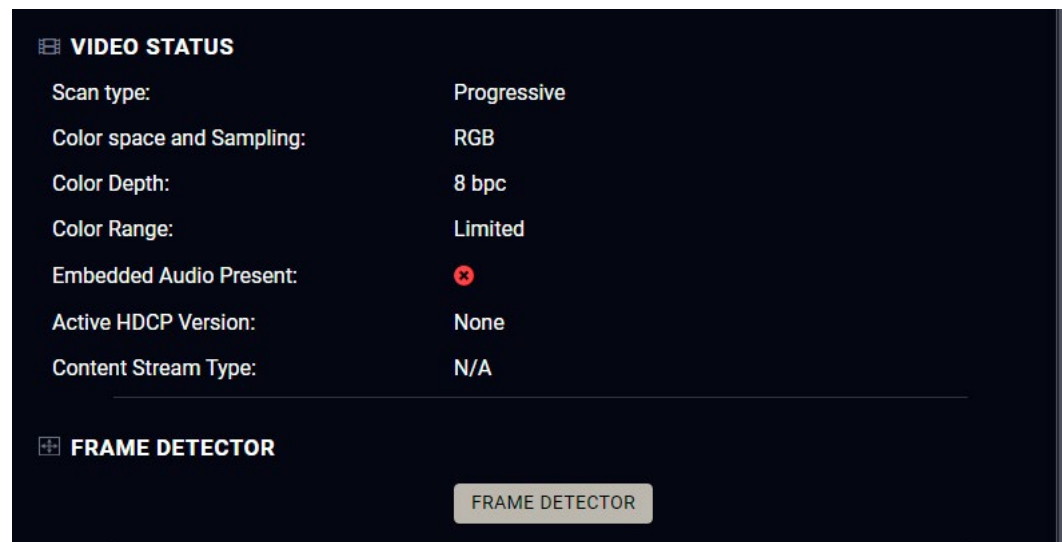

USB-C input port properties window

Frame detector

For more details, see the [Frame Detector](#) section.

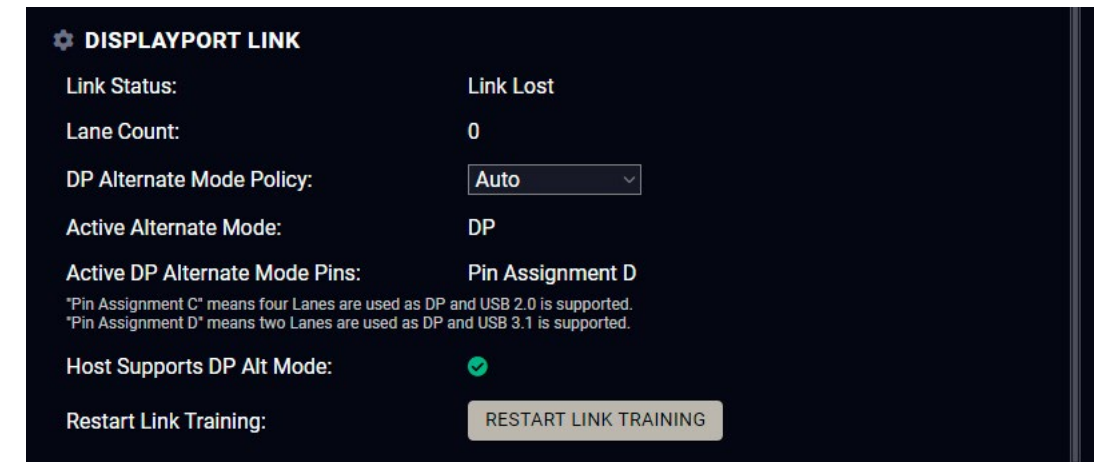
DisplayPort Link

USB-C input port properties window

INFO: The USB-C source sends Displayport video signal, so the video setting options of the USB-C port are similar to the DisplayPort. The UCX switcher converts DP signal to HDMI internally.

DP Alternate Mode Policy

The following parameters can be set:

The two different signals (video and USB 3.x) can be transmitted at the same time with shared bandwidth. In this case DP video reserves 2x Superspeed Channels for the video signal in alternate mode, and there are 2x Superspeed Channels for USB 3.x.

- **Auto:** Taurus offers both operation modes described below. The BYOD device can choose between the two. Neither USB3, nor 4 lane DP Alt mode operation (4K@60) is guaranteed. BYOD devices supporting USB3.x usually choose shared mode: USB3.1 and 2 lane DP.
- **Prefer video:** Uses 4 Lanes for Displayport video, in this case USB 3.x data transmission does not operate.
- **Prefer USB 3.1:** The two different signals (DP video and USB 3.x) can be transmitted at the same time with shared bandwidth. DP video reserves 2 Lanes.

DIFFERENCE: The DCX-2x1-HC10 model only has a forced **4 Lane Video** setting.

Restart Link Training `#linktraining`

Link training is a process where the source (PC, laptop, media server) and the sink (switcher) agree on a data rate, lane count and electrical parameters. The successful link training is a pre-requisite of the video transmission. If the quality of the USB cable is insufficient to reliably handle higher data rates, link training will result in a lower data rate, where stable connection between the source and the switcher can be maintained.

Clicking on the **Restart Link Training** button starts to build up the connection again between the switcher and the source (it happens automatically when the source is connected). It is equal to unplugging and reconnecting the Type-C connector.

6.9.3. HDMI Video Input

Clicking on the HDMI video input port icon results in opening the Port properties window. The most important information and settings are available from the panel.

INPUT 3 - HDMI IN 3

GENERAL

Port name: HDMI in 3

Lock/Mute: Lock Mute

Connected:

Signal present:

Input HPD Mode: Auto

Resolution @ Refresh Rate: 1920x1200@60Hz

Allowed HDCP Version: HDCP 2.2

HDCP 2.2 signal handling is limited to up to two ports at the same time.

VIDEO STATUS

Scan type: Progressive

Color space and Sampling: RGB

Color Depth: 8 bpc

Color Range: N/A

Embedded Audio Present:

Active HDCP Version: None

Content Stream Type: N/A

FRAME DETECTOR

FRAME DETECTOR

Port properties window of the HDMI video input

Available settings and tools

Port name

The name of a port can be changed by typing the new name and clicking on the **Set** button. The following characters are allowed when naming: Letters (A-Z) and (a-z), hyphen (-), underscore (_), numbers (0-9), and dot (.). Max length: 63 characters.

Lock *#lock #unlock*

The port can be locked to the currently connected output ports by adding a tick. If the port is locked, the crosspoint state of this port cannot be changed.

INFO: When the locked input is switched to the output, the crosspoint state can not be changed and all inputs are locked in that line.

Mute *#mute #unmute*

The incoming signal can be muted/unmuted by adding/removing a tick. If the port is muted, no signal is transmitted from the input port.

Allow HDCP Version *#hdcv*

ATTENTION! HDCP 2.2 signal handling is limited to up to two input ports at the same time.

- **Off:** The connected source will detect that the switcher is not HDCP-compliant and turn off authentication if the content allows it.
- **HDCP 1.4:** The connected source will detect that the switcher is compliant with HDCP 1.4, but not compliant with HDCP 2.2.
- **HDCP 2.2:** The connected source will detect that the switcher is compliant with HDCP 2.2.

Frame detector

For more details, see the [Frame Detector](#) section.

6.9.4. HDMI Video Output

OUTPUT 2 - HDMI OUT 2

GENERAL

Port name:

Lock/Mute: Lock Mute

Connected:

Signal present:

HDCP Mode:

VIDEO STATUS

Scan type: Progressive

Color space and Sampling: RGB

Color Depth: 8 bpc

Color Range: N/A

Active HDCP Version: None

Content Stream Type: N/A

HDCP Status: N/A

Resolution @ Refresh Rate: 1920x1200@60Hz

AUDIO STATUS

Embedded Audio Present:

Audio Sampling frequency: N/A

Audio Signal type: N/A

OUTPUT OPTIONS

Output 5V Enable:

Output Signal Type:

Embedded Audio Mute: Mute

Port properties window of the HDMI video output

Available settings and tools

General

Port name

The name of a port can be changed by typing the new name and clicking on the **Set** button. The following characters are allowed when naming: Letters (A-Z) and (a-z), hyphen (-), underscore (_), numbers (0-9), and dot (.). Max length: 63 characters.

Lock *#lock #unlock*

The port can be locked to the currently connected output ports by adding a tick. If the port is locked, the crosspoint state of this port cannot be changed.

Mute *#mute #unmute*

The incoming signal can be muted/unmuted by adding/removing a tick. If the port is muted, no signal is transmitted from the input port.

HDCP Mode *#hdc*

- **HDCP mode:** Auto / Always - The transmitter forces the source to send the signal without encryption if the content allows when Auto mode is selected; *#signaltype #hdc*

Output Options

Output 5V Enable

- Auto / On / Off - The setting lets the source and the sink devices be connected – independently of the transmitted signal.

Output Signal Type

- Auto / DVI - The outgoing signal format can be selected from a drop-down menu.

Embedded Audio Mute

Add a tick to turn off the embedded audio.

Frame detector

For more details, see the [Frame Detector](#) section.

Autoselect

Autoselect feature makes the switching of an input to an output without human intervention possible. The crosspoint state changes based on the active input signals.

Three operation policies can be set: `#autoselect` `#videoautoselect`

Disable autoselect: crosspoint state change happens manually.

First detect: selected input port is kept connected to the output as long as it has an active signal.

Last detect mode: it is always the last attached input that is selected to be transmitted.

Individual input settings: it is always the highest priority active input that is selected to be transmitted (1-highest priority, 100- lowest priority).

Pay attention to the following settings for the proper operation of the Autoselect function:

- Be sure that all priority values are filled in;
- Be sure that all inputs are enabled with the green tick on the right side;
- Always click on the **Apply autoselect settings** button after the changes to launch the new settings.

See more details about the feature in [The Autoselect Feature](#) section.

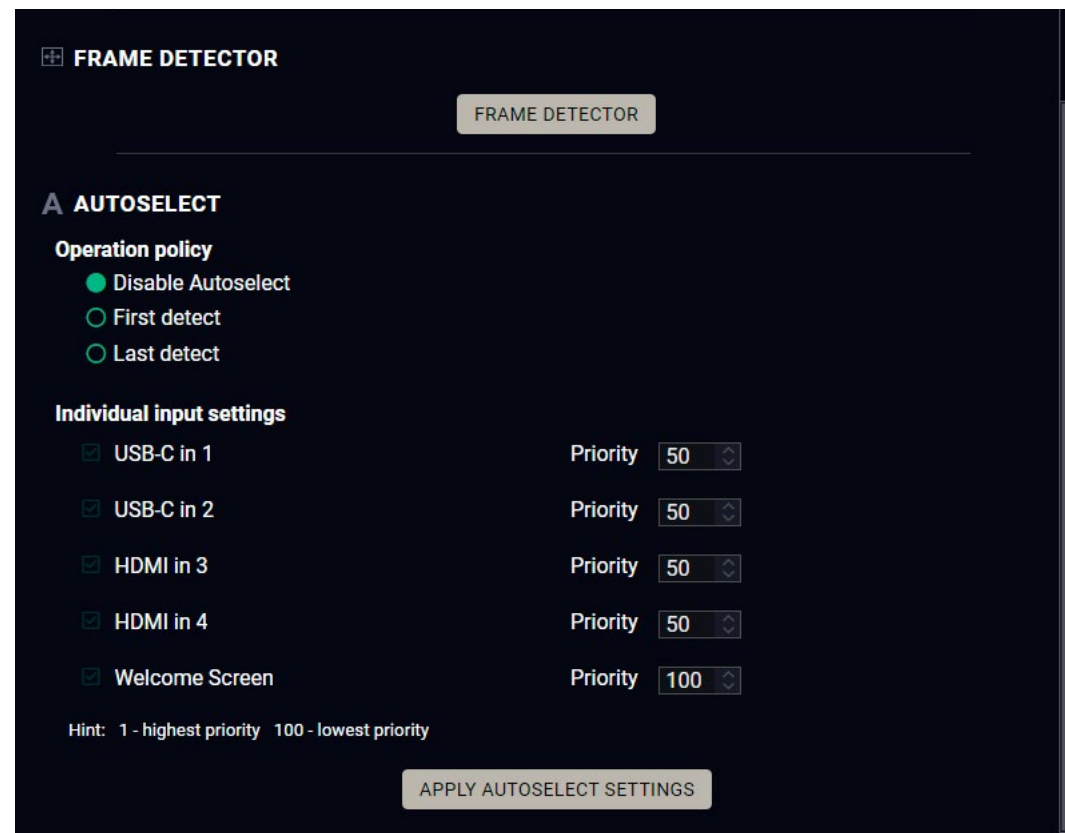

6.9.5. Embedded Audio Input



Port properties window of the audio input

Available settings

Port name

The name of a port can be changed by typing the new name and clicking on the **Set** button. The following characters are allowed when naming: Letters (A-Z) and (a-z), hyphen (-), underscore (_), numbers (0-9), and dot (.). Max length: 63 characters.

Lock `#lock` `#unlock`

The port can be locked to the currently connected output ports by adding a tick. If the port is locked, the crosspoint state of this port cannot be changed.

Mute `#mute` `#unmute`

The incoming signal can be muted/unmuted by adding/removing a tick. If the port is muted, no audio signal is transmitted from the input port.

ATTENTION! Video crosspoint has a limitation: I1 and I5 ports are not available at the same time, only one of them can be selected to any output. When I5 is selected for video source, the de-embedded audio of the I1 is not available because of the video crosspoint limitation. For more details about it, see the port diagram in the [Audio Interface](#) section.

6.9.6. Analog Audio Output

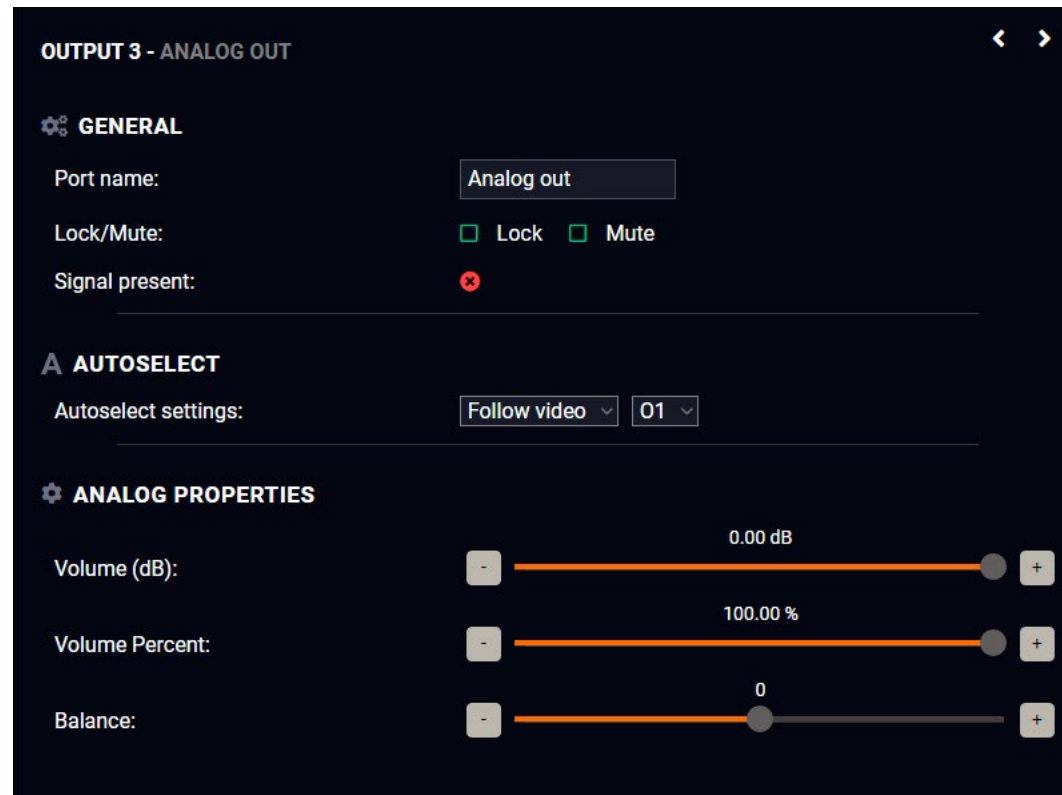

Port properties window of the analog audio output

Available settings: `#analogaudio` `#volume` `#balance`

- Port name
- Mute/unmute the port;
- Lock/unlock the port;
- Autoselect settings: off / follow video (O1 or O2). Follow video option means that the audio of the selected video input will be switched to the analog audio output. When the video crosspoint changes, audio crosspoint follows it.
- Volume: from 100 to 0%, in step 1% (0 dB to -95.625 dB, in step 0.375 dB (default is 0 dB));
- Balance: from -100 to +100, in step 1 (default is 0 = center).

INFO: The de-embedded audio is mirrored to the Dante Audio Output in case of UCX-4x2-HC30D.

6.9.7. Frame Detector

The ports can show detailed information about the signal like full size and active video resolution. This feature is a good troubleshooter if compatibility problems occur during system installation. To access this function, open the port properties window and click on the **Frame detector** button. `#framedetector`



Frame Detector Window

Lightware's Frame Detector function works like a signal analyzer and makes it possible to determine the exact video format that is present on the port, thus helps identify many problems. E.g. actual timing parameters may differ from the expected and this may cause some displays to drop the picture.

Frame Detector measures detailed timings on the video signals just like a built-in oscilloscope, but it is much easier to use. The actual display area shows the active video size (light grey). Dark grey area of the full frame is the blanking interval, which can contain the info frames and embedded audio data for HDMI signals. Shown values are measured directly on the signal and not retrieved only from the HDMI info frames.

It is possible to download the results by clicking on the **Export Data to CSV** button.

Automatic scrolling can be toggled by clicking on the **Autoscroll** checkbox in the lower right corner. It is enabled by default.

6.10. CEC Tool

The device is able to send Consumer Electronics Control (CEC) commands via the HDMI outputs. This feature is to remote control the sink device. CEC is a bi-directional communication via the HDMI cable.

#cec

ATTENTION! Make sure that the controlled unit is CEC-capable and this function is enabled.

INFO: Taurus UCX series devices are only capable of sending CEC commands, but not of receiving them.

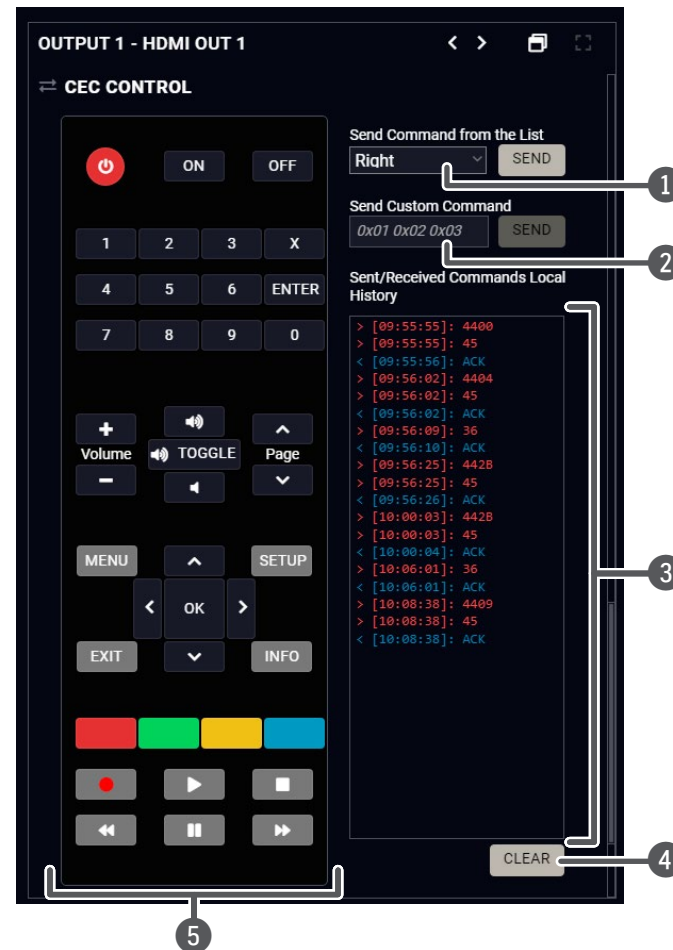

1 Drop-down command list

Containing the basic CEC commands, most of them are displayed on the graphical interface too (on the left side). Click on the **Send** button to send the command.

2 Custom command textbox

The text field is for sending hexadecimal commands in the indicated format to the source. Click on the **Send** button to send the command.

3 Received Command box

Displays all the sent CEC commands (in red) and the received answers (in blue) with a timestamp.

4 Clear button

Click on the **Clear** button to erase the content of the terminal window.

5 CEC command button panel

This panel provides the quick and easy management of CEC commands. These buttons are pre-programmed with basic functions and send commands towards the sink. The communication is displayed in the Received Command box. For the list of the commands, see the [CEC Command Sending](#) section. Both the layout and functionality are similar to the design of a remote control.

It can occur that the third-party device can receive, but not execute the command, because it is not supported by the product. Check the accepted commands in the documentation of the device.

6.11. USB Crosspoint

In USB crosspoint tab, the connection between the of the upstream ports (USB-C and USB-B ports) and the USB hub (USB-A ports) can be set. *#usb #usbc*

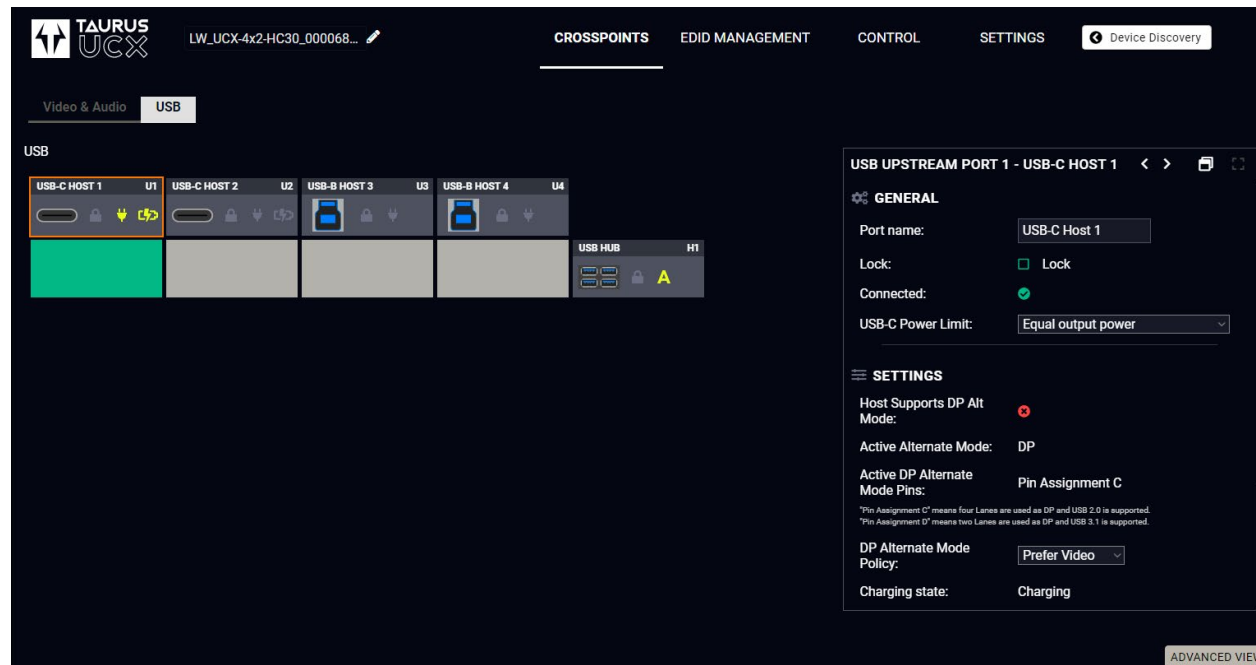

6.11.1. USB-C Port Properties

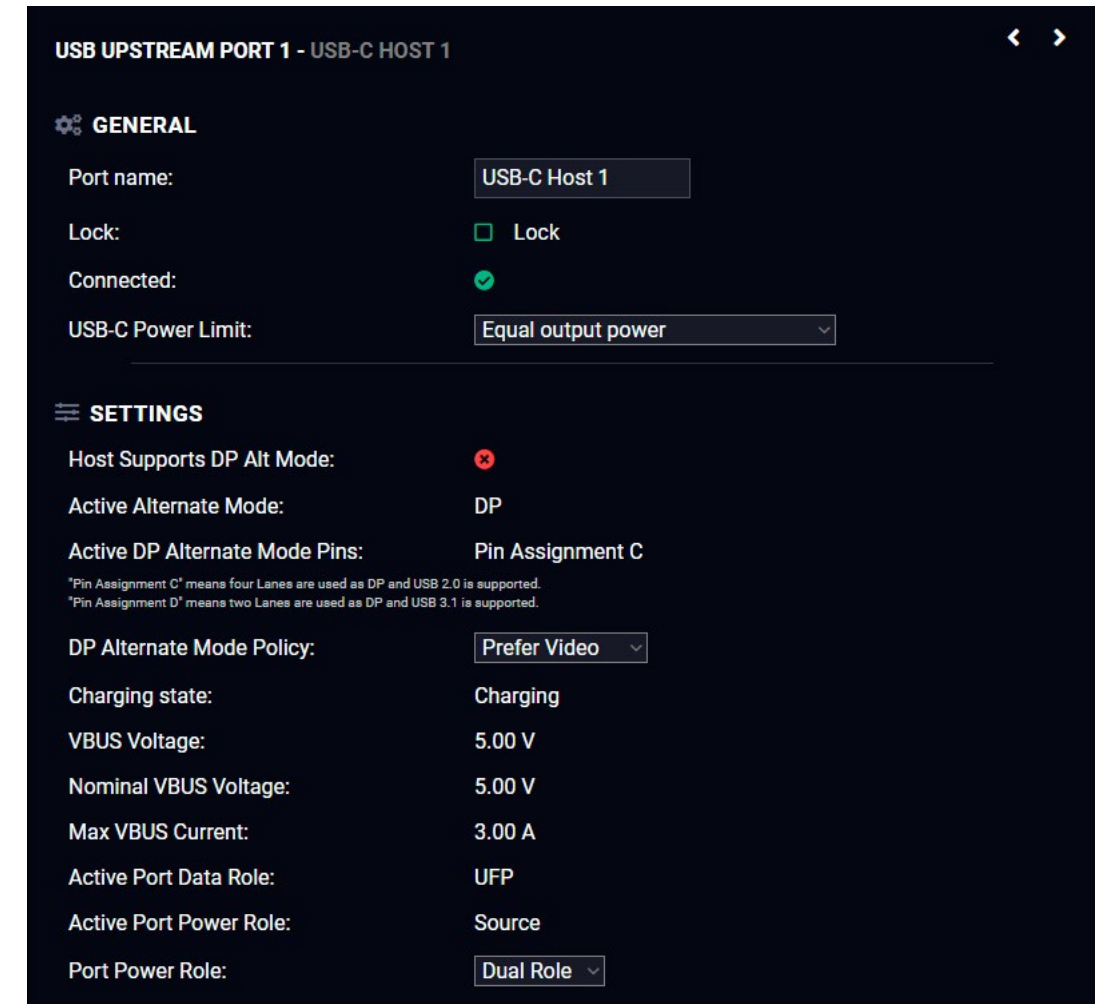

Available settings and tools

General

Port name

The name of a port can be changed by typing the new name and clicking on the **Set** button. The following characters are allowed when naming: Letters (A-Z) and (a-z), hyphen (-), underscore (_), numbers (0-9), and dot (.). Max length: 63 characters.

Lock *#lock #unlock*

The port can be locked to the currently connected output ports by adding a tick. If the port is locked, and the crosspoint state of this port cannot be changed.

USB-C Power Limit

Choose a powering option from the drop-down menu: *#power*

- **Equal output power:** both USB-C ports supplies max. 30W power.
- **Port 1 maximum, Port 2 minimum:** U1port supplies max. 60W power, U2 port supplies 5V/3A.
- **Port 2 maximum, Port 1 minimum:** U2port supplies max. 60W power, U1 port supplies 5V/3A.

Settings

DP Alternate Mode Policy

This is equal to the [DP Alternate Mode Policy](#) setting on the USB-C video port. *#dpaltmode #alternatemode #displayportalternatemode*

Power Role

Dual role: The switcher can be source (and sends power to the connected device) or sink (the switcher does not send power, real power consumption does not happen) depending on the connected device.

INFO: Using **Dual role** setting is highly recommended, the other options are mainly for troubleshooting.

Source: When the connected device is a sink (e.g. smart phone or a dual-role laptop), the switcher charges it via the USB-port.

Sink: When the power role of the connected device is source-only (e.g. PC), the switcher has to change its power role (sink or dual-role) to build up the connection. Real power consumption does not happen.

6.11.2. USB-B Port Properties



Available settings and tools *#usb #usbc*

Port name

The name of a port can be changed by typing the new name and clicking on the **Set** button. The following characters are allowed when naming: Letters (A-Z) and (a-z), hyphen (-), underscore (_), numbers (0-9), and dot (.). Max length: 63 characters.

Lock *#lock #unlock*

The port can be locked to the currently connected output ports by adding a tick. If the port is locked, the crosspoint state of this port cannot be changed.

USB Hub Properties

USB HUB DOWNSTREAM PORT 1 - USB HUB

GENERAL

Port name:

Lock: Lock

USB DEVICES

D1 Power 5V Mode:

D2 Power 5V Mode:

D3 Power 5V Mode:

D4 Power 5V Mode:

AUTOSELECT

Operation policy

Disable Autoselect

Follow video

First detect

Last detect

Follow video port setting:

Individual input settings

Host	Priority
<input checked="" type="checkbox"/> USB-C Host 1	<input type="text" value="50"/>
<input checked="" type="checkbox"/> USB-C Host 2	<input type="text" value="50"/>
<input checked="" type="checkbox"/> USB-B Host 3	<input type="text" value="50"/>
<input checked="" type="checkbox"/> USB-B Host 4	<input type="text" value="50"/>

Hint: 1 - highest priority 100 - lowest priority

Available settings and tools

General

Port name

The name of a port can be changed by typing the new name and clicking on the **Set** button. The following characters are allowed when naming: Letters (A-Z) and (a-z), hyphen (-), underscore (_), numbers (0-9), and dot (.). Max length: 63 characters.

Lock *#lock #unlock*

The port can be locked to the currently connected output ports by adding a tick. If the port is locked, the crosspoint state of this port cannot be changed.

Autoselect *#autoselect #usbautoselect*

For more details about this feature, see the [Autoselect](#) section.

Autoselect settings: Disable autoselect / Follow video / First detect / Last detect mode / Individual input settings

Follow video (O1 or O2): Follow O2 means the same computer will be the video source for O2 output and the USB Host of all USB downstream devices.

Video and USB ports either have a common USB Type-C connector for each port, or an HDMI and USB-B are clearly marked to belong together as one port.

USB Devices

The power 5V Mode can be set for each port from the drop-down menu: When the option is **Off**, the switcher does not send the device 5V over the USB-A port. Using **Auto** mode is recommended.

USB-Audio Configuration

DIFFERENCE: This setting is only available for the UCX-4x3-HC40-BD(-LCC) model.

Here you can choose the type of input device that you can route to the Dante interface.

The following audio device types can be chosen:

- Echo-canceling microphone
- Echo-reducing microphone
- Microphone (default)
- Line IO (for troubleshooting and debugging purposes)

USB-AUDIO CONFIGURATION

Audio Device Type:

6.12. EDID Menu

Advanced EDID Management can be accessed by selecting the EDID menu. There are two panels: the left one contains Source EDIDs, the right one contains Destination places where the EDIDs can be emulated or copied to.

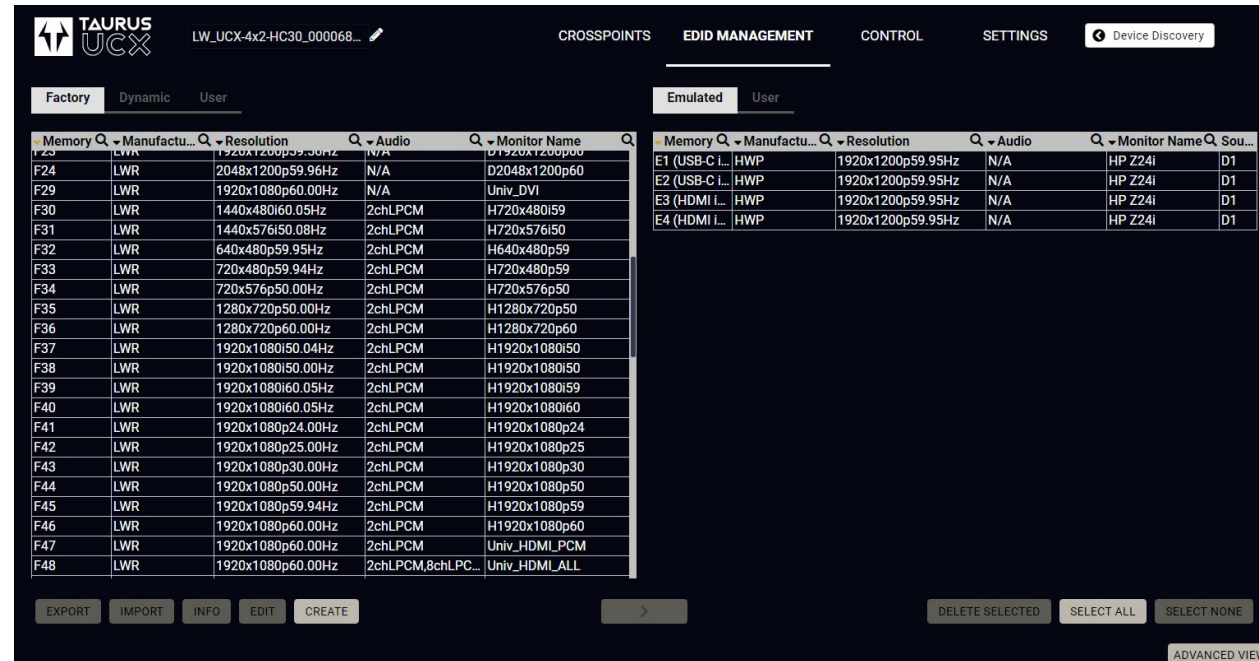

EDID Menu

Control Buttons

	Exporting an EDID (save to a file)		Transfer button: executing EDID emulation or copying
	Importing an EDID (load from a file)		Deleting EDID (from User memory)
	Display EDID Summary window		Selecting all memory places in the right panel
	Opening Advanced EDID Editor with the selected EDID		Selecting none of the memory places in the right panel
	Opening Easy EDID Creator		

#edid

6.12.1. EDID Operations

Changing Emulated EDID

- Step 1.** Choose the desired **EDID list** on the source panel and select an **EDID**.
- Step 2.** Press the **Emulated** button on the top of the Destination panel.
- Step 3.** Select the desired **port** on the right panel (one or more ports can be selected); the EDID(s) will be highlighted in yellow.
- Step 4.** Press the **Transfer** button to change the emulated EDID.

Learning an EDID

The process is the same as changing the emulated EDID; the only difference is the Destination panel: press the **User** button. Thus, one or more EDIDs can be copied into the user memory either from the factory memory or from a connected sink (Dynamic).

Exporting an EDID

- A source EDID can be downloaded as a file (*.bin, *.dat or *.edid) to the computer.
- Step 1.** Select the desired **EDID** from the Source panel (line will be highlighted in yellow).
 - Step 2.** Press the **Export** button to open the dialog box and save the file to the computer.

Importing an EDID

- A previously saved EDID (*.bin, *.dat or *.edid file) can be uploaded to the user memory:
- Step 1.** Press the **User** button on the top of the Source panel and select a **memory** slot.
 - Step 2.** Press the **Import** button below the Source panel.
 - Step 3.** Browse the file in the opening window then press the **Open** button. The browsed EDID is imported into the selected User memory.

ATTENTION! The imported EDID overwrites the selected memory place even if it is not empty.

Deleting EDID(s)

- The EDID(s) from User memory can be deleted as follows:
- Step 1.** Press the **User** button on the top of the Destination panel.
 - Step 2.** Select the desired **memory** slot(s); one or more can be selected (“Select All” and “Select None” buttons can be used). The EDID(s) will be highlighted in yellow.
 - Step 3.** Press the **Delete selected** button to delete the EDID(s).

6.12.2. EDID Summary Window

Select an EDID from the Source panel and press the **Info** button to display the EDID summary.

INFO

GENERAL

- EDID version: 1
- EDID revision: 3
- Manufacturer ID: LWR (Lightware Visual Engineering)
- Product ID: 0000
- Monitor serial number: Not present
- Year of manufacture: 2010
- Week of manufacture: Not Used
- Signal interface: Digital
- Separate Sync H&V: -
- Composite sync on H: -
- Sync on green: -
- Serration on VS: -
- Color depth: Undefined
- Interface standard: Not defined
- Color spaces: RGB 4:4:4
- Aspect ratio: 0
- Display size: 0 cm X 0 cm

EDID Summary Window

6.12.3. Editing an EDID

Select an EDID from the Source panel and press the **Edit** button to display the Advanced EDID Editor window. The editor can read and write all descriptors that are defined in the standards, including the additional CEA extensions. Any EDID from the device's memory or a saved EDID file can be loaded into the editor. The software resolves the raw EDID and displays it as readable information to the user. All descriptors can be edited, saved in an EDID file, or uploaded to the User memory. For more details about EDID Editor, please visit our website (www.lightware.com) and download the [EDID Editor Application note](#).

EDIT

EDID BYTE EDITOR

	0	1	2	3	4	5	6	7	8	9
0	00	FF	FF	FF	FF	FF	FF	00	32	F2
10	00	00	00	00	00	00	00	14	01	03
20	80	00	00	78	06	EE	91	A3	54	4C
30	99	26	0F	50	54	00	00	00	01	01
40	01	01	01	01	01	01	01	01	01	01
50	01	01	01	01	02	3A	80	D0	72	38
60	2D	40	10	2C	45	80	80	38	74	00
70	00	1E	00	00	00	10	00	00	00	00
80	00	00	00	00	00	00	00	00	00	00
90	00	00	00	FD	00	31	33	37	39	0F
100	01	0A	20	20	20	20	20	20	00	00
110	00	FC	00	44	31	39	32	30	78	31
120	30	38	30	70	35	30	00	BD		

EDID Editor Window

6.12.4. Creating an EDID - Easy EDID Creator

Since the Advanced EDID Creator mentioned above needs more complex knowledge about EDID, Lightware introduced a wizard-like interface for fast and easy EDID creation. With Easy EDID Creator, it is possible to create custom EDIDs in four simple steps. By clicking on the **Create** button below the Source panel, **Easy EDID Creator** is opened in a new window. For more details about the EDID Editor, please visit our website (www.lightware.com) and download the [EDID Editor Application note](#).

CREATE

Select Resolution & Interface

Video Format

Audio Format

Finish

Back Next

SELECT RESOLUTION & INTERFACE

Welcome to the Easy EDID Creator!

With this software you are able to create a unique EDID according to your demands. Details can be added or changed in the Advanced EDID Editor later if needed.

Please select the format type and the preferred resolution. If you don't find the proper mode in the list, use the Custom format type setting, enter the resolution and the program will estimate the best blanking times.

Important notes:

- If you want to send audio then you must select HDMI or DisplayPort. DVI and VGA do not support audio transmission.
- Most DVI displays are not able to process HDMI signals. If you have a DVI display, please check its specifications.
- The supported color depth will be 24bits/pixel by default.
- USB TYPE-C means DisplayPort interface over a different physical interface.

Format type: Broadcast

Resolution: 640x480p60

Interface type:

VGA

DVI

HDMI

DisplayPort

USB TYPE-C

EDID Creator Window

6.13. Control Menu

6.13.1. Ethernet

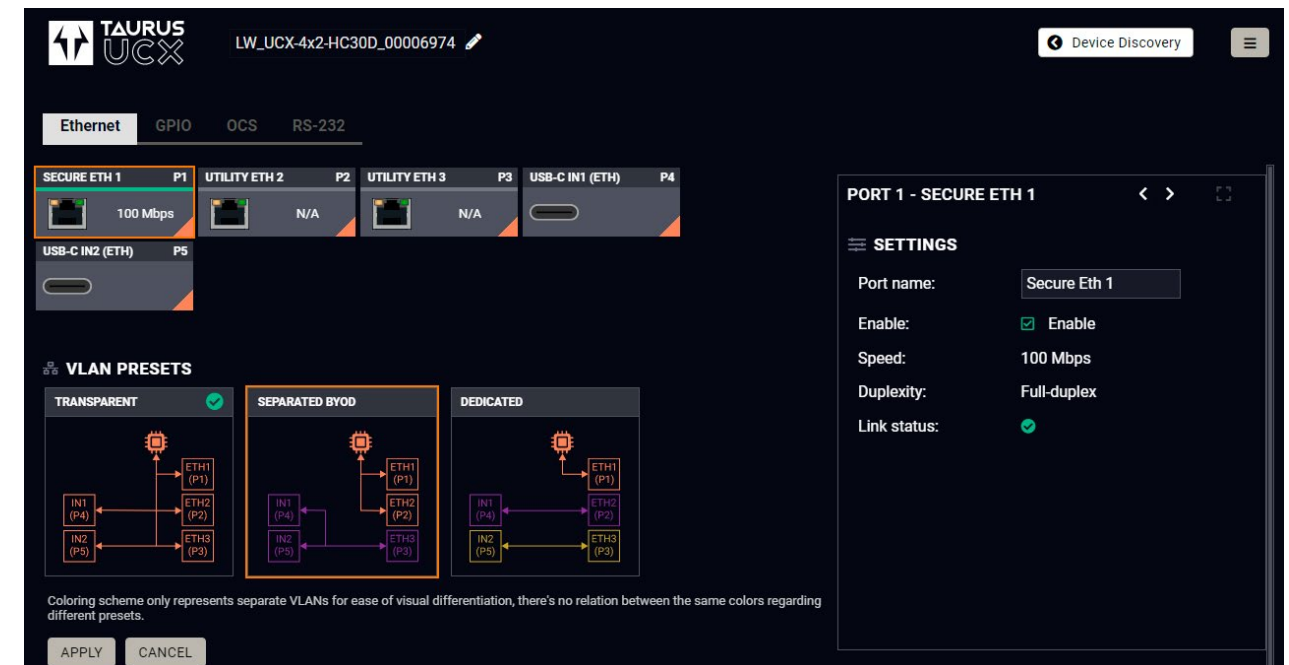

Ethernet tab in Control menu

Five ports are displayed in the Ethernet settings: Three of them belong to the RJ45 Ethernet connectors. You can check the status of the Ethernet line by each port: the speed and the duplexity of the connection. The remaining two are for configuring the Ethernet layer in the USB-C ports.

The following settings are available for each port:

- Rename the port,
- Enable / disable the port;
- VLAN membership,

VLAN preset setting can also be found here. For more information on VLAN presets, see the [Advanced Ethernet Security](#) section.

The following VLAN presets can be set:

- Transparent (default),
- Separated BYOD,
- Dedicated,
- Custom (this is not directly selectable - automatically selected if VLAN setting does not fit any preset)

VLAN Membership

The VLAN membership setting offers isolated networks for the chosen ports that are independent from the management network and even each other. Further management options will be implemented in a later firmware update.

6.13.2. GPIO

DIFFERENCE: This feature is available only from FW package v1.1.0b7.

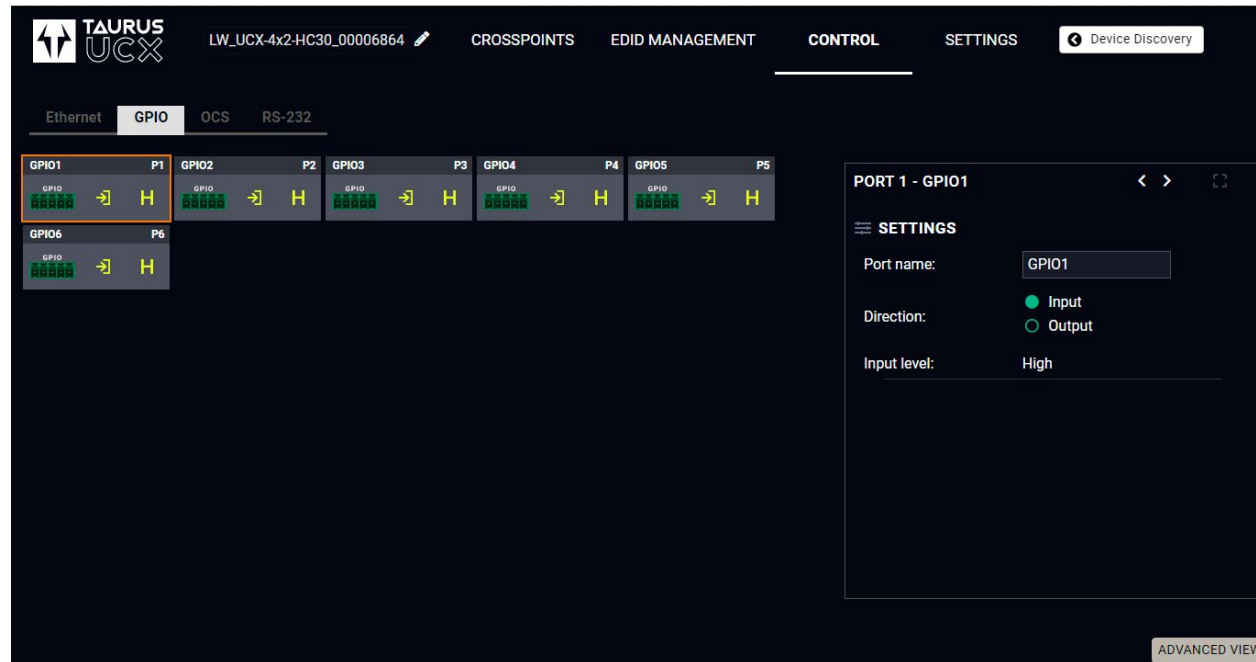

DIFFERENCE: The DCX-2x1-HC10 switcher does not have a GPIO port.

The GPIO port has 6 pins, which operate at TTL digital signal levels and can be controlled by LDC or protocol commands. Select a GPIO pin under the Port settings section; the settings (pin direction and input level) are displayed on the port tiles as well. `#gpio`

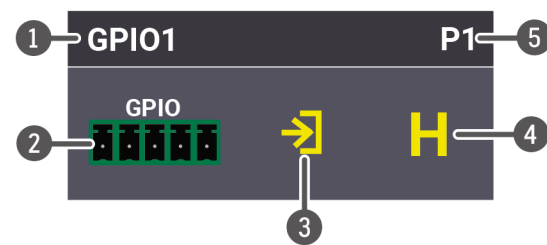

INFO: Output level can be set only if the pin direction is set to Output. In case of input direction, the output level setting and the **Toggle** button is not available.



- 1 GPIO pin name
- 2 GPIO Port symbol
- 3 Pin direction:
 -  Input
 -  Output
- 4 Level indicator:
 - L:** Low
 - H:** High
- 5 GPIO Port number

Interval

Interval section is designed for setting the chosen GPIO pin to the specified level for a specified time. Configure the **Duration** time and the **Logic level** of the desired value. Confirm by clicking the **Set interval** button.

6.13.3. OCS - Occupancy Sensor

DIFFERENCE: This feature is available only from FW package v1.1.0b7.

DIFFERENCE: The DCX-2x1-HC10 switcher does not have an OCS port.

The OCS sensor has 3 pins, where the first pin is a 24V logic input. The default state is high. Different type of sensors exist: some send high level, some send low level to this input when the room is occupied. Active-high or active-low logic might be configured for this port in LDC to support them.

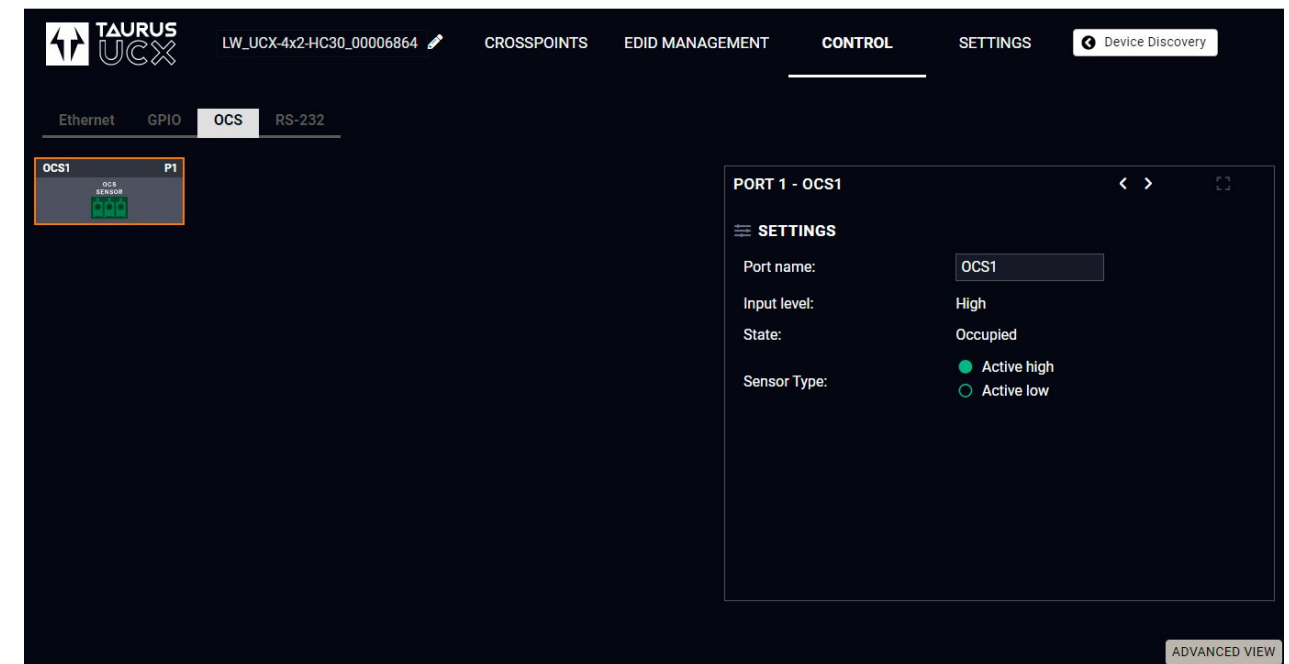

Input level refers to the current input signal level of the first pin.

State value can be free or occupied, depending on the Sensor type setting and the Input level (e.g. when the sensor type is Active high and the input value is high, the state reports 'Occupied').

Sensor type can be active high/active low, and this defines whether the low or high input level means the occupancy.

`#ocs`

6.13.4. RS-232

DIFFERENCE: UCX-2x1-HC30, UCX-2x1-HC40 and DCX-3x1-HC20 models are assembled with one local RS-232 port.

DIFFERENCE: This feature is available only from FW package v1.2.0.

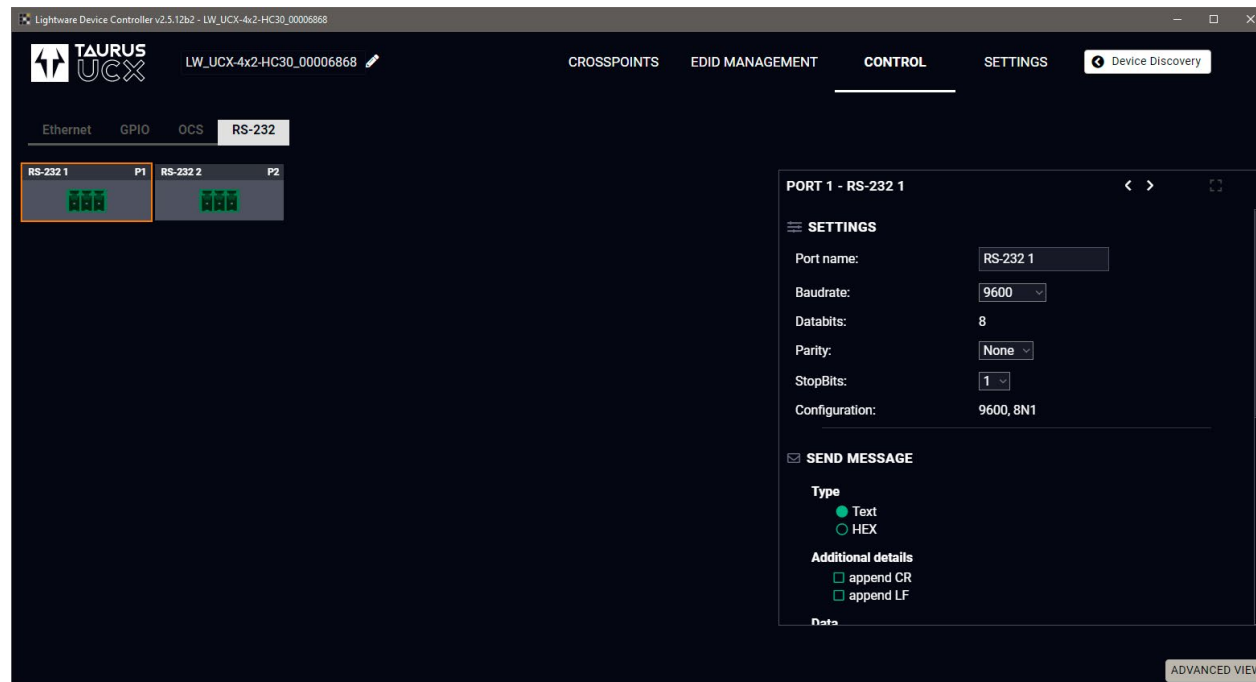

RS-232 tab in Control menu

DIFFERENCE: The DCX-2x1-HC10 switcher does not have an RS-232 port.

The following settings and functions are available: `#rs-232` `#serial`

- **Baud rate:** 9600, 14400, 19200, 38400, 57600, 115200;
- **Data bits:** 8;
- **Parity:** None, Odd, or Even; `#rs232`

Send Message Section

DIFFERENCE: This feature is available from FW package v1.3.1b1.

The serial message sending is achieved by Lightware REST API, and it can be in text or hexadecimal format. The CR/LF (Carriage Return/Line Feed) can be enabled optionally.

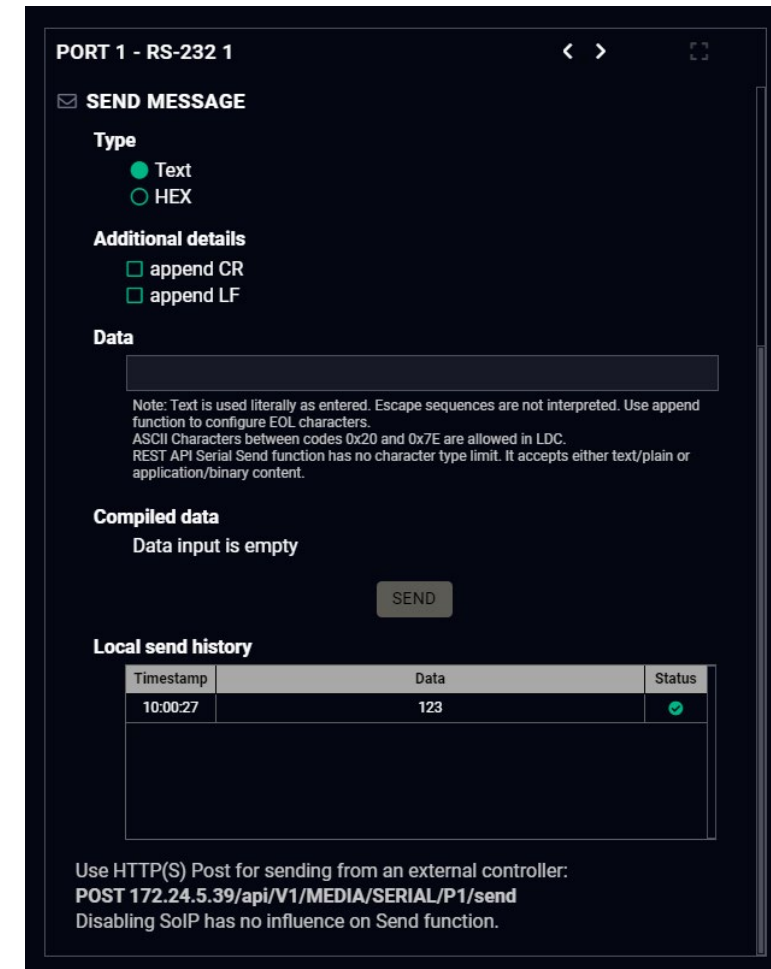

6.14. Settings Menu

6.14.1. Status

DIFFERENCE: The dark mode, identify me and control lock features are available only from FW package v1.2.0. `#devicelabel #label #producttype #firmwareversion #status #serialnumber`

Dark mode enable: When Dark mode is enabled, all LEDs on the unit are switched off (after 60 seconds by default) if no buttons are pressed. Pressing any button brings back the status info on the LEDs without performing the function of the button itself. `#darkmode`

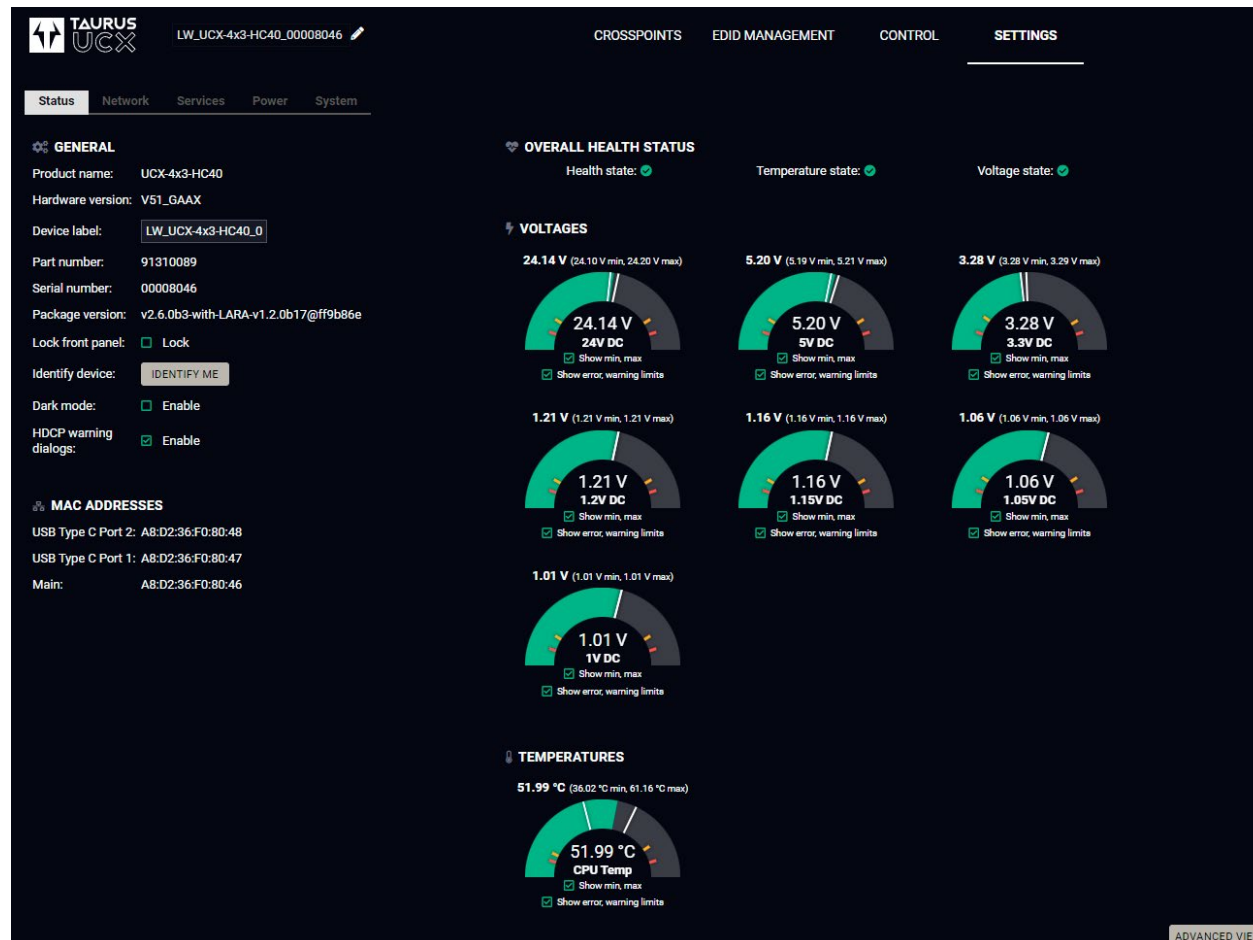

Status tab in Settings menu

The most important hardware and software related information can be found on this tab: hardware and firmware version, serial numbers, MAC addresses, temperatures, and voltage information. Device label can be changed to a unique description by the **Set** button. `#buttonlock #lockbutton`

You can disable the functionality of the front panel buttons by marking the Lock front panel option. This is same method of the control lock enabled by the front panel buttons. See the details in the [Control Lock](#) section.

Clicking on the **Identify me** button results in the blinking of the status and crosspoint LEDs in green for 10 seconds. The feature helps to identify the device itself in the rack shelf.

6.14.2. Network

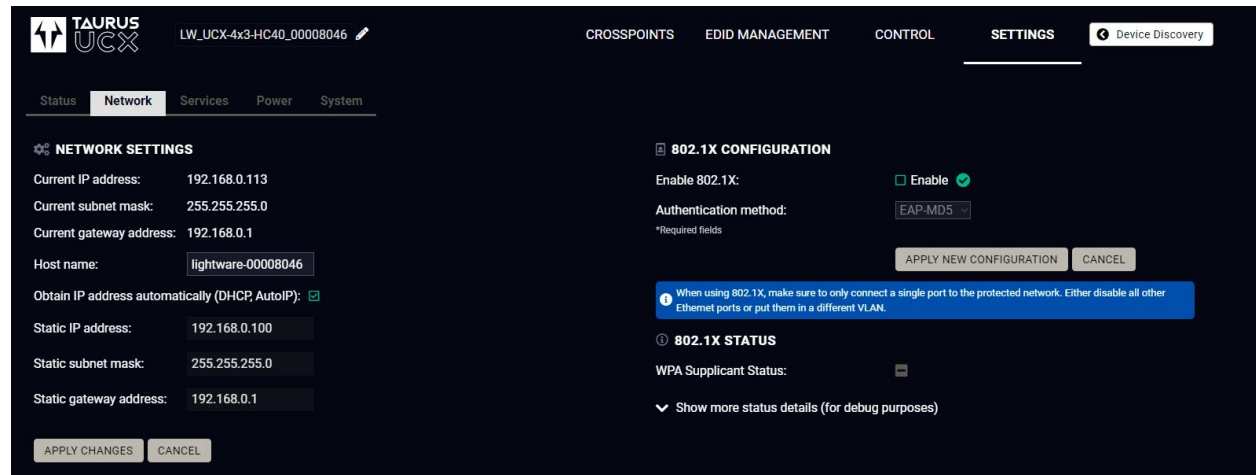

Network tab in Settings menu

Network Settings

IP address and DHCP settings can be set on this tab. Always press the **Apply settings** button to save changes. When the host name is modified, clicking on the **Restart http(s) services** button is also needed.

INFO: A new certificate is generated after the hostname changing.

802.1x Configuration

Authentication Process

You will find the 802.1x authentication section in the right.

You can enable authentication by ticking in the Enable box. Once 802.1x authentication is enabled, you can choose the authentication method from the drop-down menu: **EAP-MD5** or **EAP-TLS**.

DIFFERENCE: From firmware version v2.12.0, EAP-MD5 is unavailable.

When using EAP-MD5, authentication will require an Identity and a Password to gain access to the secure network.

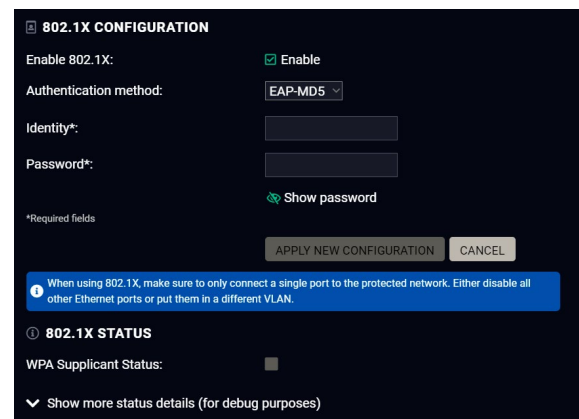

With EAP-TLS, you will also need CA and Client certificates, a Client Private Key, and a password for the Key.

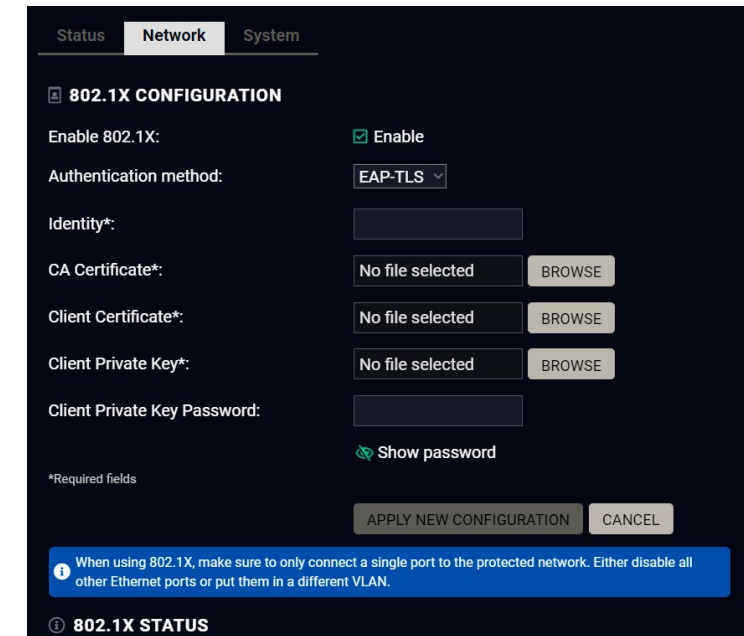

After entering every necessary information, click on the **Apply new configuration** button, and the authentication process starts.

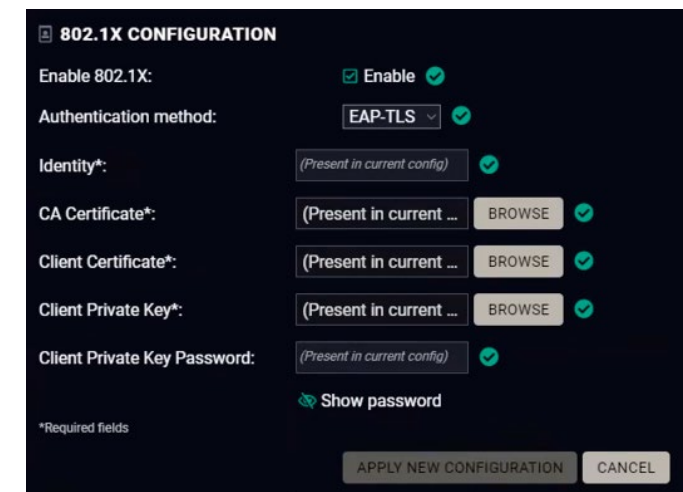

If every component is correct, the device will gain access to the secure LAN.

6.14.3. Services

The Services tab is available from LDC version v2.7.0.

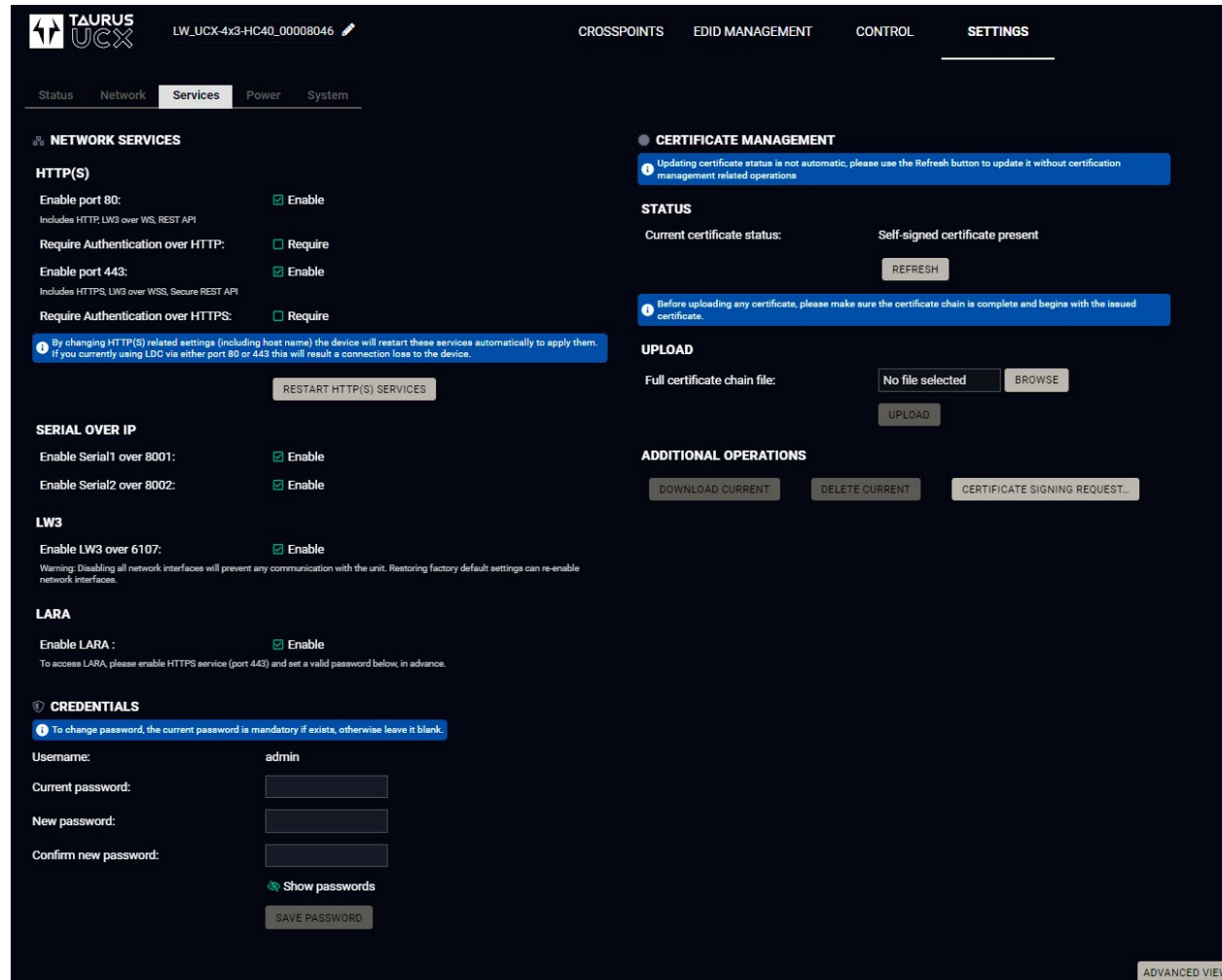

Services tab in the Settings menu

Network Services

DIFFERENCE: Network services are available only from FW package v1.2.0.

HTTP/HTTPS

UCX series switcher provides HTTP/HTTPS server services on its 80 and 443 ports to make it accessible over WebSocket (WS), LW3 protocol, using Lightware Device Controller and REST API for device control (see the detailed list about the additional available features in the summary table of the [Lightware Advanced Room Automation \(LARA\)](#) section).

HTTPS protocol encrypts the transferred data to keep it protected. For more details about the HTTPS, see the [Encryption \(HTTPS, WSS\)](#) section. [#portblock](#) [#network](#) [#http](#) [#https](#)

- **Enable/Disable HTTP/ HTTPS port:** To ensure the secure data traffic, the HTTP port (80) can be disabled, and the all the information can be transferred via HTTPS (443 port).

80 or 443 port is necessary to upload/download WelcomeScreen image, UserScripts, log and clone files so one of them should be opened to reach these functions.

DIFFERENCE: UserScripts are only available with up to firmware version v1.4.4. From firmware version v1.5.0, LARA replaces functions previously managed by UserScripts.

ATTENTION! Please ensure proper UCX time and date setting in UCX, because it affects the self-signed certificate (SSL) generation when using WSS or HTTPS. Improper time and date setting may lead to certificate rejection.

- **Require Authentication over HTTP/HTTPS:** authentication helps limit the access to the device by setting a username (admin) and a password. For more details, see the [Basic Authentication](#) section. No password is set by default, the authentication can be enabled after setting a password.
- **Restart HTTP(S) Services** is required after the authentication settings changed.

Serial over IP

The signal route of the serial-IP transmission can be broken by disabling the serial over 8001 or 8002 port. For more details about the RS-232, see the [Serial Interface](#) section.

LW3

Enable LW3 over 6107: LW3 protocol commands, Lightware Device Controller software.

WARNING! The Lightware Device Controller software operates on 6107 port, when it is disabled, the UCX series switcher can be controlled only with protocol commands via http(s). [Reset to Factory Default Settings](#) can re-enable the network interfaces.

LARA

LARA can be enabled by ticking in the box after enabling HTTPS and setting a password, which can be done below.

Credentials

DIFFERENCE: From firmware version v2.11.0 and LDC version v2.8.0, password history is maintained in authentication, not allowing for the last 10 passwords to be set again.

The authentication password can be set here for HTTP/HTTPS ports. UTF-8 characters are allowed. Min length: 10 characters, max length: 100 characters. The password string can not be queried. [#password](#)

ATTENTION! If a wrong password is entered during login five times in a row, all login attempts are denied for 15 minutes.

New Password

DIFFERENCE: From firmware version v2.0.0, the old password is also required when changing the password.

ATTENTION! Authentication feature in UCX series is not equal to the Cleartext login feature in the Advanced Control Pack in the TPS family extenders.

Certificate Management

DIFFERENCE: This feature is available from firmware version v2.2.0.

You can upload certificates signed by the Certificate Authority (CA) to provide secure connection to the devices with the webLDC.

To download a Certificate Signing Request (CSR), follow these steps:

Step 1. Navigate to the Settings menu, Services tab and click on the **Certificate Signing Request** button.

Step 2. Enter the data required for the authentication process. It is important to provide all information related to your organization, because it will be used to verify your identity.

Step 3. Once all the necessary data has been entered, the file can be downloaded via the button in the bottom, and sent for signing.

Step 4. When the CA signs the certificate, it will create a .pem file, which then can be uploaded onto the device.

Step 5. After uploading, press the **Refresh** button in the Certificate Management section and the signed certificate shall be active.

Please be aware that the certificate will use the device's own private key and will not work for any other device. Each device must have its own certification.

The certificate signing request form

Information	Description	Example
Common Name	The domain name you wish to secure.	www.example.com
Organization Name	The legal name of the company or organization, any suffix included.	Lightware Visual Engineering PLC
Organizational Unit	The name of the internal organizational department/division.	IT
Locality	The name of the city, town, village etc. of the organization.	Budapest
State	Province, region, county or state, not abbreviated.	Pest county
Country	The country of the organization can be chose from the drop-down menu.	Hungary
Email Address	The contact address of the certificate administrator or the IT department of the company.	example@lightware.com

In the Subject Alt Name(s) field you can enter additional information for more hosts to be certified with one SSL. The information type can be chosen from the drop down menu. You can have several Subject Alt Name fields.

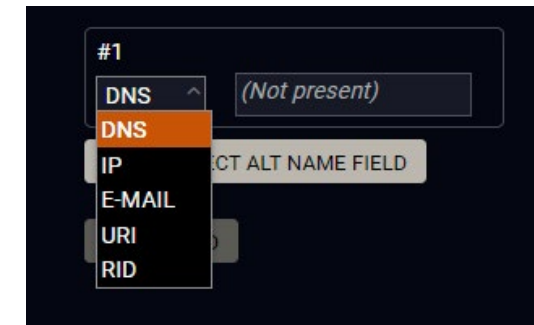

You can enter the following information in the Subject Alt Name field:

- DNS
- IP address
- E-mail address
- URI
- RID

6.14.4. Power

DIFFERENCE: This tab is only available for UCX-4x3-HC40, UCX-4x2-HC30, UCX-4x2-HC30D, UCX-4x2-HC40D and UCX-4x3-HC40-BD devices with the following FW and HW versions:

- LDC version v2.7.2b5
- FW version v2.5.0
- HW version below v2.4 for UCX-4x2-HC30(D) devices

The screenshot shows the 'Power' tab in the settings menu. It includes sections for Power Budget Information, Power Distribution Settings, and Overall Power Usage.

	USB-C Port U1	USB-C Port U2
Reserved Power	60 W	60 W
Power Allocation Mode	Static	Static
Allocated Power	60 W	60 W

Overall Power Usage: USB-C Port U1 (purple bar), USB-C Port U2 (teal bar).

Power tab in the Settings menu

On this tab you can set the power output by each capable port.

Power Budget Information

- **Total Power Budget:** you can see the full amount of power available for output.
- **Unreserved Power Budget:** you can see the amount of power that remains after the amount has been set on all ports.
- **Unallocated Power Budget:** you can see the amount of power that remains available in case one of the Power Allocation Mode on a port is set to Auto. If needed, this power amount will be automatically provided for the port.

Power Distribution Settings

In this table you can quickly and efficiently set the power capabilities of each port.

- **Reserved Power:** You can choose a minimum amount of power to be output on the port from a drop-down menu.
- **Power Allocation Mode:** You can set whether the port shall be capable of outputting more than the minimum amount set in the line above. In case of **Static**, the port will output the set amount. In case of **Auto**, the port may use any unallocated power in addition to the given minimum to supply to the device connected to it if needed.
- **Allocated Power:** total amount of power output by the port.

Enabling 100W power to first connected device

In order for a USB-C port to be able to supply 100W, the amount of reserved power must be sufficient. If the user wants to allocate 100W to the first connected device, regardless of which USB-C port it is connected to, the setting must be arranged as follows:

PoE On

- Step 1.** Make sure that **Power Allocation Mode** for all ports is **Static**.
- Step 2.** Choose **30W** of **Reserved Power** for the TPX PoE column.
- Step 3.** Set the **Reserved Power** for both USB-C ports to **15W**.
- Step 4.** Turn **Power Allocation Mode** to **Auto** for the USB-C ports.

This will enable the transmitter so supply the first connected device with up to 100W, while the other port will be able to supply 20W.

PoE Off

- Step 1.** Make sure that **Power Allocation Mode** for all ports is **Static**.
- Step 2.** Choose **0W** of **Reserved Power** for the TPX PoE column.
- Step 3.** Set the **Reserved Power** for both USB-C ports to a maximum of **30W**.
- Step 4.** Turn **Power Allocation Mode** to **Auto** for the USB-C ports.

This will enable the transmitter so supply the first connected device with up to 100W, while the other port will be able to supply 50W.

6.14.5. System

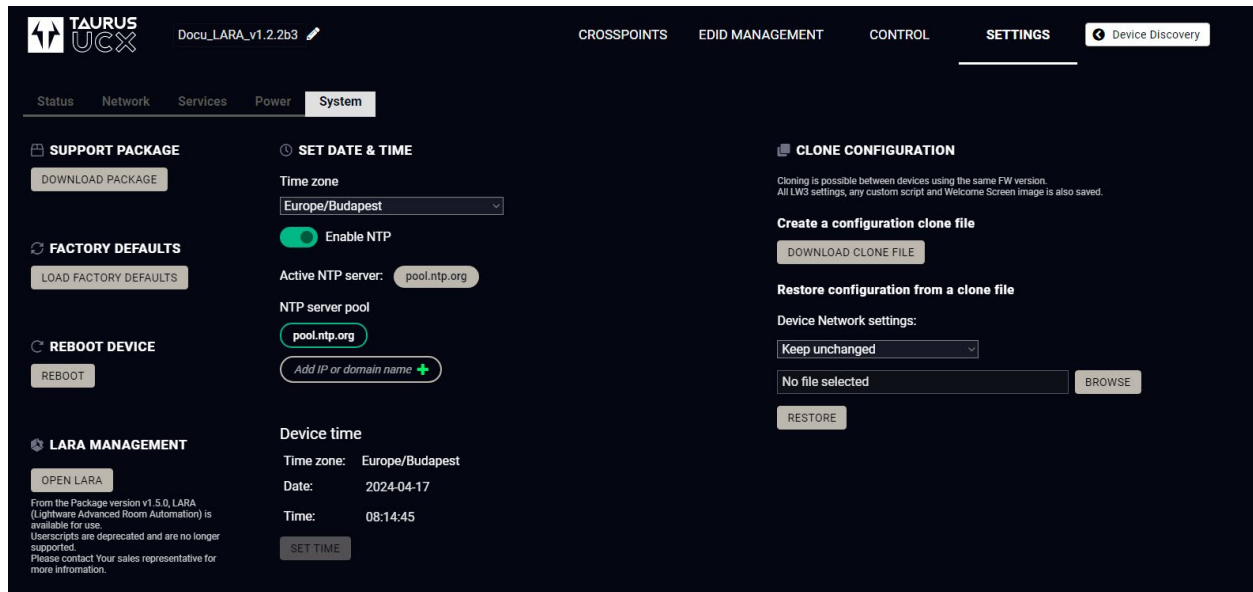

System tab in Settings menu

The following functions are available under the System tab:

- **Support package** - saving a log file of the device, helps during the troubleshooting process
- **Load factory defaults** - recalling factory default settings and values. All factory default settings are listed in the [Factory Default Settings](#) section.
- **Reboot** - rebooting the system.
- **LARA management** - opening the LARA
- **Set time** - (internal clock) of the switcher, which is used for logging events.
- Pressing the **Sync with Computer** button is a quick and easy way to set the time. `#factory #log #systemlog #reboot #restart`

ATTENTION! Please ensure proper UCX time and date setting in UCX, because it affects the self-signed certificate (SSL) generation when using WSS or HTTPS. Improper time and date setting may lead to certificate rejection.

Script management

DIFFERENCE: This feature is available only from FW package v1.0.1b1 to v1.4.4. From firmware version v1.5.0, LARA replaces functions previously managed by UserScripts.

This interface is for running custom zipped files, which are made by Lightware per special requests.

Add a tick to enable the **Run script**. It means that the script runs until another script is uploaded or this function is disabled.

Click on **Upload File** to browse a zipped file. It will replace the previous one.

LARA management

The LARA interface can be opened by clicking on the Open LARA button.

DIFFERENCE: LARA is available in UCX devices from firmware version v1.5.0.

Set Date & Time

DIFFERENCE: From FW version v2.9.0 and LDC version v2.7.6, NTP management is available for time and date setting.

To enable Network Time Protocol (NTP), the device must be able to reach an NTP server either online or a local server.

Manual time and date setting is available when NTP is disabled.

Clone configuration

DIFFERENCE: This feature is available only from FW package v1.1.0b7.

Clone configuration makes saving all the LW3 settings, custom scripts and welcome screen image and uploading them to another device possible.

ATTENTION! Please note that clone configuration function operates properly when the same firmware version is installed on the devices.

ATTENTION! If the device that the clone configuration is created on is password protected, the devices where this file is uploaded will also ask for a password. However, as passwords are not saved in the configuration file, the password is reset to **admin**.

Create a configuration clone file

Click on the **Download Clone File** button to save the setting to the computer.

Restore a configuration from a clone file

Step 1. Choose the desired network setting from the drop down menu:

- Keep unchanged.
- Restore from clone file (hostname will change, because the hostname property is also cloned from the original device and it can affect the generated certificates of the 443 port).
- Set to DHCP mode.
- Set to custom non-DHCP mode (in this case additional settings required: IP Address, Subnet Mask, Gateway Address).

INFO: The network settings relates to Static or DHCP setting/ IP address/ Subnet mask/ Gateway address and the hostname property. Network service settings (enable http(s) ports, authentication etc.) will be always restored.

Step 2. Click on the **Select file** button to browse a clone file from the PC.

Step 3. The cloning process will start by clicking on the **Restore** button.

See the entire list of the saved data in the backup file in the [Content of the Backup File](#) section.

6.15. Advanced View Window

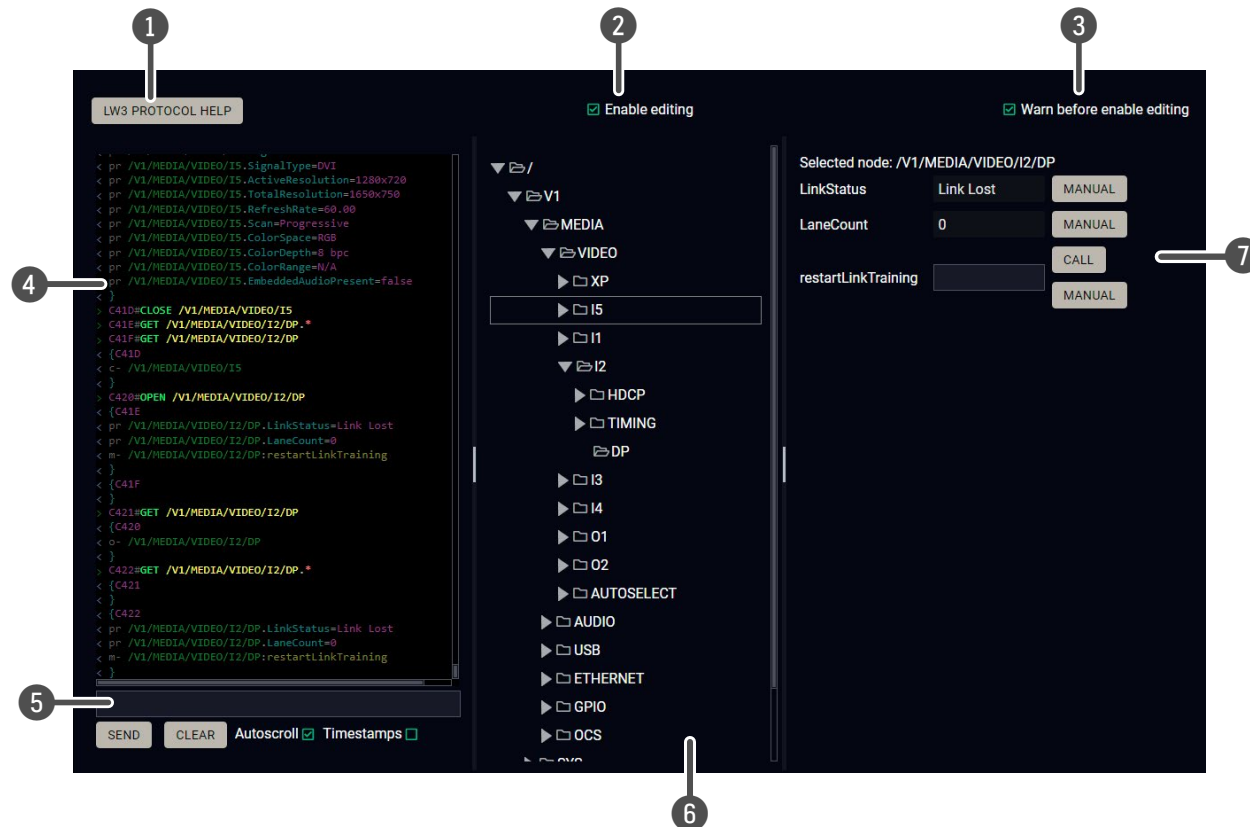

- 1 LW3 protocol help** Pushing the button results in a help window opening, which describes the most important information about LW3 protocol commands in HTML format.
- 2 Edit mode** The default appearance is the read-only mode. If you want to modify the values or parameters, tick the option. You will be prompted to confirm your selection.
- 3 Warning mode** If this is checked, a warning window pops up when you enable Edit mode.
- 4 Terminal window** Commands and responses with time and date are listed in this window. Sent command starts with '>' character, received response starts with '<' character. The color of each item depends on the type of the command and response. The content of the window can be emptied by the **Clear** button. If the **Autoscroll** option is ticked, the list is scrolled automatically when a new line is added.
- 5 Command line** Type the desired command and execute it by the **Send** button. Clear all current commands and responses in the Terminal window by the **Clear** button.
- 6 Protocol tree** LW3 protocol tree; select an item to see its content.
- 7 Node list** Correspondent parameters and nodes are shown that are connected to the selected item in the protocol tree.
 - Manual button:** Manual (short description) of the node can be called and displayed in the terminal window.
 - Set button:** Saves the value/parameter typed in the textbox.
 - Call button:** Calls the method, e.g. reloads factory default settings.

#advancedview
#terminal

TIPS AND TRICKS: You can browse the previously entered commands by using the **Up** and **Down** arrows in the Command line.

7

Lightware REST API Reference

The device can be controlled through standard HTTP(S) requests to ensure the control functions from web browsers or terminal program. This feature is available from 1.2.0 firmware package.

- ▶ [OVERVIEW](#)
- ▶ [INSTRUCTIONS FOR THE TERMINAL APPLICATION USAGE](#)
- ▶ [PROTOCOL RULES](#)
- ▶ [REST API SECURITY](#)
- ▶ [SYSTEM COMMANDS](#)
- ▶ [VIDEO PORT SETTINGS - GENERAL](#)
- ▶ [WELCOME SCREEN SETTINGS](#)
- ▶ [VIDEO PORT SETTINGS - USB-C RELATED COMMANDS](#)
- ▶ [CEC COMMAND SENDING](#)
- ▶ [AUDIO PORT SETTINGS](#)
- ▶ [USB PORT SETTINGS](#)
- ▶ [USB PORT SETTINGS - USB-C RELATED COMMANDS](#)
- ▶ [EDID MANAGEMENT](#)
- ▶ [ETHERNET PORT CONFIGURATION](#)
- ▶ [NETWORK SECURITY](#)
- ▶ [ADVANCED ETHERNET SECURITY](#)
- ▶ [SERIAL PORT CONFIGURATION](#)
- ▶ [SERIAL PORT MESSAGING](#)
- ▶ [GPIO PORT CONFIGURATION](#)
- ▶ [OCS PORT CONFIGURATION](#)
- ▶ [UPDATING THE DEVICE VIA REST API](#)
- ▶ [LIGHTWARE REST API QUICK SUMMARY](#)

7.1. Overview

The Lightware REST API is designed to provide a platform-free interface, where the UCX series switchers can be controlled by HTTP requests. REST API is a software architectural style based on HTTP protocol, so it can be used via web browser, Node.js, terminal programs.

The UCX series device provides a REST API server where most of the LW3 commands are available (for more details, see the [Lightware REST API vs. LW3 Protocol](#) section).

Lightware devices can be controlled with LW3 protocol commands (for more details, see [LW3 Programmers' Reference](#)). LW3 protocol consist of read-only, read-write properties and methods, which operate in the same way as REST API GET/POST methods. This is not a new protocol, the LW3 tree structure became available via HTTP(s).

7.2. Instructions for the Terminal Application Usage

7.2.1. Web Browser Plugins

REST API interface can be easily accessed via a web browser's plugin, see the two examples below:

Mozilla Firefox - RESTClient

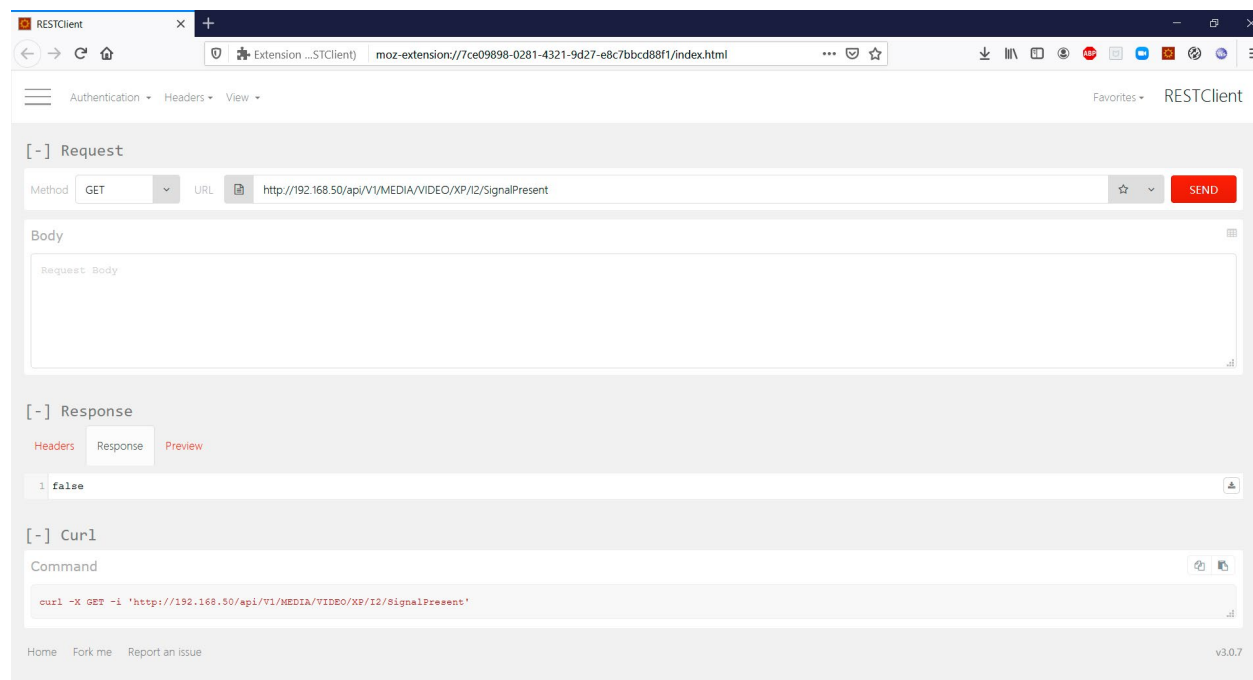

RESTClient plugin for Mozilla Firefox

Google Chrome - Advanced Rest Client

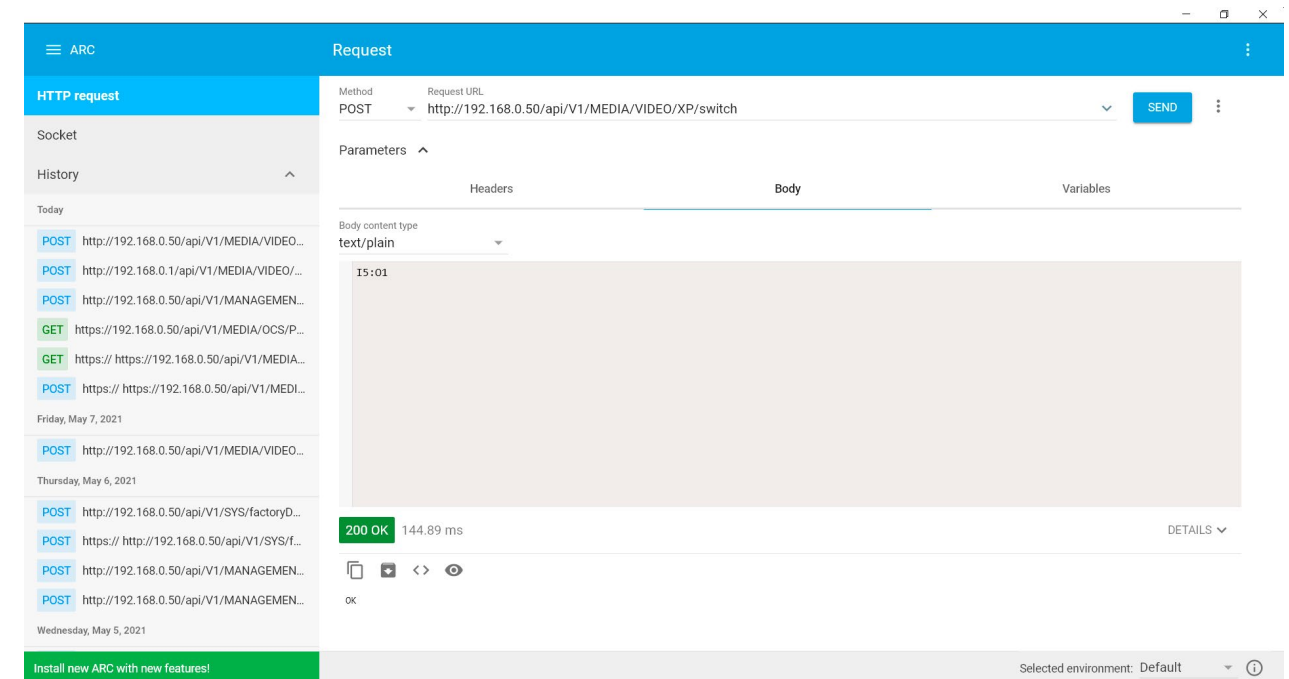

Advanced Rest Client for Google Chrome

7.2.2. Terminal Application

The REST API requests can be applied to the switcher using a terminal application. You need to install one of them on your control device, for example, Putty, CLI or Curl. *#terminal*

Curl

Curl is a command line tool that can also connect to the Taurus REST SERVER and display communication in a terminal window. It supports data transferring with HTTP and HTTPS standards and handles the basic authentication (username and password) in Windows® and Linux operating systems. Multi-line commands are also accepted, so a script can be stored in a .txt file for future reference.

Check if the Curl package is installed on your system. Type into your console: `curl`. When the answer is 'curl: try 'curl --help' for more information', curl is installed.

Some web browser plugins (e.g. REST Client) display the curl version of the sent request.

Once the terminal window is opened, you can enter the commands. Some typical examples are listed in the following section.

```

Microsoft Windows [Version 10.0.19042.985]
(c) Microsoft Corporation. All rights reserved.

C:\Users\Juca>curl
curl: try 'curl --help' for more information

C:\Users\Juca>curl -i -X GET http://192.168.0.55/api/V1/MEDIA/VIDEO/XP/I2/SignalPresent
HTTP/1.1 200 OK
X-Powered-By: Express
Content-Type: application/json; charset=utf-8
Content-Length: 5
ETag: W/"5-flbvuyullyqbUJDeLlF/4U0SywQ"
Date: Sat, 13 May 2034 12:30:41 GMT
cache-control: max-age=86400,private
Server: lighttpd/1.4.56

false

C:\Users\Juca>curl -X POST -i http://192.168.0.55/api/V1/MEDIA/GPIO/P1/interval --data Low;1
HTTP/1.1 200 OK
X-Powered-By: Express
Content-Type: text/plain; charset=utf-8
Content-Length: 2
ETag: W/"2-n009QiTiwXgNtWtBJezz8kv3SLc"
Date: Sat, 13 May 2034 12:31:24 GMT
cache-control: max-age=86400,private
Server: lighttpd/1.4.56

OK
C:\Users\Juca>_

```

REST API communication in a command line window

GET Command Example

Query the Signal Presence

```
curl -i -X GET <ip>/api/<NodePath>/<PropertyName>
```

```

C:\Users\Juca>curl -i -X GET http://192.168.0.55/api/V1/MEDIA/VIDEO/XP/I2/SignalPresent
HTTP/1.1 200 OK
X-Powered-By: Express
Content-Type: application/json; charset=utf-8
Content-Length: 5
ETag: W/"5-flbvuyullyqbUJDeLlF/4U0SywQ"
Date: Sat, 13 May 2034 13:39:24 GMT
cache-control: max-age=86400,private
Server: lighttpd/1.4.56

false

```

POST Command Example 1.

Set the Mute State

```
curl -X POST -i <ip>/api/<NodePath>/<PropertyName> --data <value>
```

```

C:\Users\Juca>curl -X POST -i http://192.168.0.55/api/V1/MEDIA/VIDEO/XP/I2/Mute --data true
HTTP/1.1 200 OK
X-Powered-By: Express
Content-Type: text/html; charset=utf-8
Content-Length: 5
ETag: W/"5-hg914ZeUflab5o9bn2uUeaPo3CI"
Date: Sat, 13 May 2034 13:48:09 GMT
cache-control: max-age=86400,private
Server: lighttpd/1.4.56

true

```

POST Command Example 2.

Switch video crosspoint

```
curl -X POST -i <ip>/api/<NodePath>/<PropertyName> --data <value>
```

```

C:\Users\Juca>curl -X POST -i http://192.168.0.55/api/V1/MEDIA/VIDEO/XP/switch --data I2:01
HTTP/1.1 200 OK
X-Powered-By: Express
Content-Type: text/plain; charset=utf-8
Content-Length: 2
ETag: W/"2-n009QiTiwXgNtWtBJezz8kv3SLc"
Date: Sat, 13 May 2034 14:02:01 GMT
cache-control: max-age=86400,private
Server: lighttpd/1.4.56

OK

```

POST Command with Basic Authentication Example

Switch video crosspoint

```
curl --user <username>:<password> -X POST -i <ip>/api/<NodePath>/<PropertyName>
--data <value>
```

```
C:\Users\Juca>curl --user admin:pwd -X POST -H -i http://192.168.0.110/api/V1/MEDIA/VIDEO/XP/
switch --data I2:01
OK
```

HTTPS Command Example 2.

Switch video crosspoint

```
curl -X POST -k -i <ip>/api/<NodePath>/<PropertyName> --data <value>
```

```
C:\Users\Juca>curl -X POST -k -i https://192.168.0.110/api/V1/MEDIA/VIDEO/XP/switch --data I2:01
HTTP/1.1 200 OK
X-Powered-By: Express
Content-Type: text/plain; charset=utf-8
Content-Length: 2
ETag: W/"2-n009QiTIwXgNtWtBJezz8kv3SLc"
Date: Sun, 28 May 2034 12:28:20 GMT
cache-control: max-age=86400,private
Server: lighttpd/1.4.56
OK
```

7.3. Protocol Rules

7.3.1. Command Structure Example

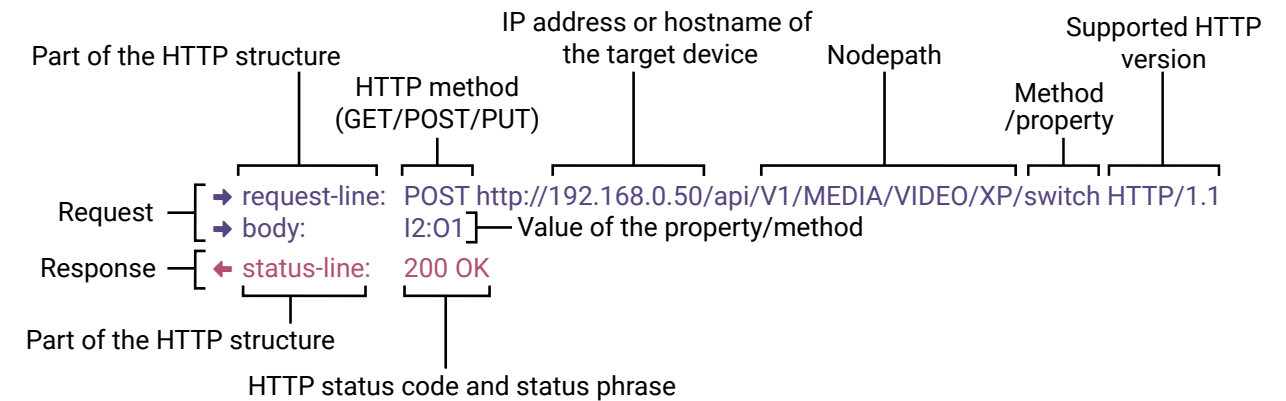

The examples below show how to apply the REST API in different environments:

Curl in Command Line Terminal

```
→ curl -X POST -i http://192.168.0.55/api/V1/MEDIA/VIDEO/XP/switch --data I2:01
```

REST API Client in Mozilla

```
Method: POST
URL: http://192.168.0.55/api/V1/MEDIA/VIDEO/XP/switch
Body content type: text/plain
Body: I2:01
```

7.3.2. General Rules

- All names and parameters are case-insensitive.
- The methods, nodes and properties are separated by a slash ("/) character.
- The node name consists of letters of the English alphabet and numbers.
- All properties and methods are available HTTP(S) below /api as an URL.
- The HTTP server is available on port 80, the HTTPS server is available on port 443.
- GET / PUT/ POST methods are supported.
- The request-line contains the IP address (or hostname) and the nodepath.
- Arguments and property values should be given in the HTTP request's body as a plain text.
- REST API - LW3 converter does escaping automatically.
- The node paths describe the exact location of the node, listing each parent node up to the root.
- The supported HTTP protocol: standard HTTP/1.1
- There is no maximum size or character length of the request.

7.3.3. Legend for the Control Commands

Command and Response – Example

→ request-line: GET·<ip>/api/V1/MEDIA/VIDEO/<in>/SignalPresent

→ body: <status code>

Format	Description
<ip>	IP address or hostname of the target device
<in>	Input port number
<out>	Output port number
<port>	Input or output port number
<loc>	Location number
<parameter>	Variable defined and described in the command
<expression>	Batched parameters: the underline means that more expressions or parameters can be placed by using a semicolon, e.g. <u>I2;I4;I5</u> or <u>F27:E1;F47:E2</u>
→	Sent request
←	Received response
·	Space character

Further, not listed <parameters> are defined at each command.

7.3.4. Lightware REST API vs. LW3 Protocol

All methods and properties of the LW3 tree structure appear below /api as a HTTP(s) URL. The separator character is always a slash (/) character instead of point (.) and colon (:). The URL is case-insensitive.

Example

The LW3 property:

/V1/MEDIA/VIDEO/I2.ActiveResolution

Available in REST API:

192.168.0.1/api/V1/MEDIA/VIDEO/I1/ActiveResolution

192.168.0.1/API/v1/media/video/i1/activeresolution

The following features are implemented only in REST API, but not in LW3 protocol:

- [Sending a Message via RS-232](#)

The most important commands are listed in this chapter. Other commands can be inferred by the LW3 tree structure, where the read-only (eg. **pr** /V1/MEDIA/VIDEO/I5.Connected) and read-write properties (**pw** /V1/MEDIA/VIDEO/I5.Name) can be listed. For more details about the LW3 tree structure, see the [LW3 Programmers' Reference](#) section or the [Advanced View Window](#).

7.3.5. Method Types

GET Method

GET method can be used to get the value of a property. It works the same way as the LW3 GET command.

PUT/ POST Method

In this case, POST and PUT are equivalent, they are for modifying read-write properties and invoking methods. They replace the LW3 SET and CALL commands.

7.3.6. Supported Commands

Querying property value (GET)

The requested value is in the body of the response.

Protocol	Command
REST API	→ request-line: GET·<ip>/api/<NODEPATH>/<PropertyName>
Example	→ request-line: GET http://192.168.0.1/api/V1/MEDIA/VIDEO/XP/I2/SignalPresent
LW3	▶ GET·/<NODEPATH>.<PropertyName>
Example	▶ GET /V1/MEDIA/VIDEO/XP/I2.SignalPresent

Setting property value (SET)

The desired property value should be given as a plain text in the body of the request. The new value is in the body of the response.

Protocol	Command
REST API	→ request-line: POST·<ip>/api/<NODEPATH>/<PropertyName> → body: <new_value>
Example	→ request-line: POST http://192.168.0.1/api/V1/MEDIA/VIDEO/XP/I2/Mute → body: false
LW3	▶ SET·/<NODEPATH>.<PropertyName>=<new_value>
Example	▶ SET /V1/MEDIA/VIDEO/XP/I2.Mute=false

Invoking method (CALL)

The argument should be given in the body of the request.

Protocol	Command
REST API	→ request-line: POST·<ip>/api/<NODEPATH>/<methodName> → body: <new_value>
Example	→ request-line: POST http://192.168.0.1/api/V1/MEDIA/VIDEO/XP/switch → body: I5:01
LW3	▶ CALL·/<NODEPATH>:<methodName>(<value>)
Example	▶ CALL /V1/MEDIA/VIDEO/XP:switch(I5:01)

7.3.7. Not Supported Commands

Querying node (GET)

Protocol	Command	Note
REST API	Not supported	404 error code
LW3	▶ GET·/·<NODEPATH>	
Example	▶ GET /V1/MEDIA/VIDEO	

Subscribing to a node (OPEN)

Protocol	Command	Note
REST API	Not interpreted	Not supported
LW3	▶ OPEN·/·<NODEPATH>	
Example	▶ OPEN /V1/MEDIA/VIDEO	

Unsubscribing from a Node (CLOSE)

Protocol	Command	Note
REST API	Not interpreted	Not supported
LW3	▶ CLOSE·/·<NODEPATH>	
Example	▶ CLOSE /V1/MEDIA/VIDEO	

7.3.8. Status Codes, Error Messages

The standard HTTP response codes are defined to supply information about the response and the executed command like:

Error code		Description
200	OK	Standard response for successful HTTP request.
401	Unauthorized	
405	Method Not Allowed	A request method is not supported for the requested resource. This is the error code when trying to modify a read-only property.
404	Not Found	Invalid nodepath or property name.
406	Not Acceptable	LW3 server error response for POST and PUT method, equals the following LW3 error codes: pE : an error for the property mE : an error for a method
500	Internal Server Error	All other errors (Lw3ErrorCodes_InternalError).

7.3.9. Polling

Subscription and unsubscription features are not supported, they can be substituted with polling. It means that a custom user script sends a request for a detected property from time to time.

7.4. REST API Security

The REST API is designed with two security features: **Authentication** and **Encryption**. Both of them are optional and can be used independently of each other.

7.4.1. Authentication

Basic access authentication is designed to limit user access for the REST API server. It requires user authentication by using a password (username is fixed).

Follow the instructions below to set the password:

Step 1. Set the password.

- ➔ request-line: POST·<ip>/api/V1/MANAGEMENT/NETWORK/AUTHENTICATION/setPassword
- ➔ body: <new_password>

Step 2. Enable the basic authentication on the chosen port (HTTP: 80 or HTTPS: 443).

- ➔ request-line: POST·<ip>/api/V1/MANAGEMENT/NETWORK/SERVICES/HTTP/AuthenticationEnabled
- ➔ body: true

Step 3. Restart network services.

- ➔ request-line: POST·<ip>/api/V1/MANAGEMENT/NETWORK/SERVICES/HTTP/restart

ATTENTION! The password will not be encrypted by this authentication mode, it remains accessible when the communication happens on HTTP.

For more details, see the [Basic Authentication](#) section.

7.4.2. Encryption (HTTPS)

There is no encryption when the REST API communication happens via HTTP, because the HTTP protocol is not encrypted. The REST API server is available via HTTPS on the 443 port. To avoid the data interception (e.g. stealing the password) HTTP should be disabled and HTTPS protocol should be used instead.

ATTENTION! Please ensure proper UCX time and date setting in UCX, because it affects the self-signed certificate (SSL) generation when using WSS or HTTPS. Improper time and date setting may lead to certificate rejection.

HTTPS does not guarantee that the communication is secure. Make sure that the client communicates with the server directly, without any third-party element in the communication route (Man-in-the-middle attack).

For more details, see the [Encryption \(HTTPS, WSS\)](#) section.

7.5. System Commands

7.5.1. Setting the Device Label

INFO: The device label can be changed to a custom text in the [Status](#) tab of the LDC software.

Request and Response *#devicelabel #label*

- request-line: POST http://<ip>/api/V1/MANAGEMENT/LABEL/DeviceLabel
- body: <custom_name>
- status-line: 200·OK
- body: <custom_name>

The Device Label can be 49 characters long and ASCII characters are allowed. Longer names are truncated.

Example

- request-line: POST http://192.168.0.50/api/V1/MANAGEMENT/LABEL/DeviceLabel
- body: UCXroom
- ← status-line: 200 OK
- ← body: UCXroom

7.5.2. Resetting the Device

The switcher can be restarted – the current connections will be terminated.

Request and Response *#reboot #restart*

- request-line: POST http://<ip>/api/V1/SYS/restart

INFO: The body has to be empty, and the content type should be text/plain.

- status-line: 200 OK

Example

- request-line: POST http://192.168.0.50/api/V1/SYS/restart HTTP/1.1
- ← status-line: 200 OK

7.5.3. Restoring the Factory Default Settings

Request and Response

- request-line: POST http://<ip>/api/V1/SYS/factoryDefaults

INFO: The body has to be empty, and the content type should be text/plain.

- status-line: 200 OK

Example

- request-line: POST http://192.168.0.50/api/V1/SYS/factoryDefaults
- ← status-line: 200 OK

The device is restarted, current connections are terminated, and the default settings are restored. See the complete list in the [Factory Default Settings](#) section. *#factory*

7.5.4. Querying the Firmware Package Version

Request and Response *#firmwareversion*

- request-line: GET http://<ip>/api/V1/MANAGEMENT/UID/PACKAGE/Version
- status-line: 200·OK
- body: <firmware_version>

Example

- request-line: GET http://192.168.0.50/api/V1/MANAGEMENT/UID/PACKAGE/Version
- ← status-line: 200 OK
- ← body: 1.0.0b2

7.5.5. Control Lock

Enable/disable the operation of the front panel buttons.

Request and Response *#lockbutton #buttonlock*

- request-line: POST http://<ip>/api/V1/MANAGEMENT/UI/ControlLock
- body: <lock_status>
- status-line: 200·OK
- body: <lock_status>

Parameters

Parameter	Parameter description	Values	Value description
<lock_status>	Front panel button locking status	None	None: all functions of the front panel button are enabled.
		locked	The front panel buttons are locked, and can be unlocked by a button combination (Control Lock).
		force locked	The front panel buttons are locked and cannot be unlocked by a button combination, only in LDC (on the Status tab) or using the LW3 command (or REST API).

Example

- request-line: POST http://192.168.0.50/api/V1/MANAGEMENT/UI/ControlLock
- body: force locked
- ← status-line: 200 OK
- ← body: Force locked

7.5.6. Setting the Current Time

Request and Response *#time*

→ request-line: POST http://<ip>/api/V1/MANAGEMENT/DATETIME/setTime
 → body: <current_time>
 → status-line: 200 OK
 → body: OK

Parameters

<current_time>: The new router time in ISO 8601 date time format.

Example

→ request-line: POST http://192.168.0.50/api/V1/MANAGEMENT/DATETIME/setTime
 → body: 2034-05-06T14:47:25
 ← status-line: 200 OK
 ← body: OK

7.5.7. Identifying the Device

Calling the method makes the status LEDs blink for 10 seconds. The feature helps find the device physically.

Request and Response *#identifyme*

→ request-line: POST http://<ip>/api/V1/MANAGEMENT/UI/identifyMe
 INFO: The body has to be empty, and the content type should be text/plain.
 → status-line: 200 OK

Example

→ request-line: POST http://192.168.0.50/api/V1/MANAGEMENT/UI/identifyMe
 ← status-line: 200 OK

7.5.8. Toggling the Dark Mode Setting

The LEDs of the device can be switched off if their light could be annoying. In Dark mode all the LEDs are switched off, except the LEDs of the RJ45 connectors (Ethernet and TPS IN). *#darkmode*

Request and Response

→ request-line: POST http://<ip>/api/V1/MANAGEMENT/UI/DARKMODE/Enable
 → body: <mode_state>
 → status-line: 200 OK
 → body: <mode_state>

Parameters

If the <mode_state> parameter is **true** (or **1**), the Dark mode function is **enabled**, if the parameter is **false** (or **0**), the function is **disabled**.

Example

→ request-line: POST http://192.168.0.50/api/V1/MANAGEMENT/UI/DARKMODE/Enable
 → body: true
 ← status-line: 200 OK
 ← body: true

7.5.9. Setting the Delay of the Dark Mode

The Dark mode can be enabled right away, or after a certain time. Thus, the mode is enabled if no buttons are pressed for a while. Pressing any button brings back the status info on the LEDs without performing the function of the button itself. The delay time can be set with this command.

Request and Response

→ request-line: POST http://<ip>/api/V1/MANAGEMENT/UI/DARKMODE/Delay
 → body: <delay_time>
 → status-line: 200 OK
 → body: <delay_time>

Parameters

The <delay_time> parameter means seconds, and the default value is 0. If set to 0, no delay is applied, and the Dark mode can be enabled immediately by the **DarkModeEnable** property. This delay has an effect on the **wakeFromDarkMode** method as well.

Example

→ request-line: POST http://192.168.0.50/api/V1/MANAGEMENT/UI/DARKMODE/Delay
 → body: 10
 ← status-line: 200 OK
 ← body: 10

7.6. Video Port Settings - General

7.6.1. Switching the Video Input

Request and Response

- request-line: POST http://<ip>/api/V1/MEDIA/VIDEO/XP/switch
- body: <in>:<out>
- status-line: 200 OK

Example

- request-line: POST http://192.168.0.50/api/V1/MEDIA/VIDEO/XP/switch
- body: I5:01
- ← status-line: 200 OK

INFO: When using the '0' value as an input, the input will be disconnected and no signal will appear on the output.

ATTENTION! Video crosspoint has a limitation: I1 and I5 ports are not available at the same time, only one of them can be selected to any output. When one of the outputs is switched to I1 or I5, the other output can not be switched to I1 or I5. In this case the switch command returns an error message.

Example

- request-line: GET http://192.168.0.50/api/V1/MEDIA/VIDEO/XP/O1/ConnectedSource
- ← body: I5
- request-line: GET http://192.168.0.50/api/V1/MEDIA/VIDEO/XP/O2/ConnectedSource
- ← body: I5
- request-line: POST http://192.168.0.50/api/V1/MEDIA/VIDEO/XP/switch
- body: I1:01
- ← header: 405 Method Not Allowed

7.6.2. Switching an Input to All Outputs

Request and Response

- request-line: POST http://<ip>/api/V1/MEDIA/VIDEO/XP/switchAll
- body: <in>
- status-line: 200 OK

Example

- request-line: POST http://192.168.0.50/api/V1/MEDIA/VIDEO/XP/switchAll
- body: I1
- ← status-line: 200 OK

7.6.3. Locking the Video Port

Request and Response

- request-line: POST http://<ip>/api/V1/MEDIA/VIDEO/XP/<port>/Lock
- body: <locked_state>
- status-line: 200 OK
- body: <locked_state>

Parameters

Parameter	Parameter description	Values	Value description
<locked_state>	Locked state	true	The port is locked
		false	The port is unlocked

Example

- request-line: POST http://192.168.0.50/api/V1/MEDIA/VIDEO/XP/I2/Lock
- body: false
- ← status-line: 200 OK
- ← body: false

7.6.4. Muting the Video Port

Request and Response

- request-line: POST http://<ip>/api/V1/MEDIA/VIDEO/XP/<port>/Mute
- body: <muted_state>
- status-line: 200 OK
- body: <muted_state>

Parameters

Parameter	Parameter description	Values	Value description
<muted_state>	Muted state	true	The port is locked.
		false	The port is unlocked.

Example

- request-line: POST http://192.168.0.50/api/V1/MEDIA/VIDEO/XP/I2/Mute
- body: false
- ← status-line: 200 OK
- ← body: false

7.6.5. Setting the Autoselect Policy

Request and Response

→ request-line: POST-http://<ip>/api/V1/MEDIA/VIDEO/AUTOSELECT/<out>/Policy
 → body: <autoselect_mode>
 → status-line: 200 OK
 → body: <autoselect_mode>

Parameters

Parameter	Parameter description	Values	Value description
<autoselect_mode>	The autoselect policy	Off	The autoselect function is disabled.
		Last Detect	It is always the last attached input that is automatically switched to the output.
		First Detect	The first active video input is selected.

Example

→ request-line: POST http://192.168.0.50/api/V1/MEDIA/VIDEO/AUTOSELECT/02/Policy
 → body: First detect
 ← status-line: 200 OK
 ← body: First detect

7.6.6. Changing the Autoselect-Included Input Ports

Request and Response

→ request-line: POST-http://<ip>/api/V1/MEDIA/VIDEO/AUTOSELECT/<out>/<in>/Included
 → body: <state>
 → status-line: 200 OK
 → body: <state>

Parameters

Parameter	Parameter description	Values	Value description
<state>	The chosen input is ignored in the autoselect process or not.	true	The port is included in autoselect.
		false	The autoselect function ignores that port.

Example

→ request-line: POST http://192.168.0.50/api/V1/MEDIA/VIDEO/AUTOSELECT/02/I1/Included
 → body: false
 ← status-line: 200 OK
 ← body: false

7.6.7. Changing the Input Port Priority

Request and Response

→ request-line: POST-http://<ip>/api/V1/MEDIA/VIDEO/AUTOSELECT/<out>/<in>/Priority
 → body: <prio_num>
 → status-line: 200 OK
 → body: <prio_num>

Parameters

The <prio> parameter means the priority number from 1 to 100, equal numbers are allowed. Inputs can have different priorities in relation with two or more outputs. Therefore the output port number is part of the node path of input port priorities.

Example

→ request-line: POST http://192.168.0.50/api/V1/MEDIA/VIDEO/AUTOSELECT/02/I2/Priority
 → body: 51
 ← status-line: 200 OK
 ← body: 51

7.6.8. Querying the Connected Source

Request and Response

→ request-line: GET-http://<ip>/api/V1/MEDIA/VIDEO/XP/<out>/ConnectedSource
 → status-line: 200-OK
 → body: <in>

Example

→ request-line: GET http://192.168.0.50/api/V1/MEDIA/VIDEO/XP/02/ConnectedSource
 ← status-line: 200 OK
 ← body: I1

7.6.9. Querying the Connected Destinations

Request and Response

→ request-line: GET-http://<ip>/api/V1/MEDIA/VIDEO/XP/<in>/ConnectedDestinations
 → status-line: 200-OK
 → body: ["<out1>";"<out1>"]

Example

→ request-line: GET http://192.168.0.50/api/V1/MEDIA/VIDEO/XP/I3/ConnectedDestinations
 ← status-line: 200 OK
 ← body: ["01";"02"]

7.6.10. Querying the Input Switching Capability

Video crosspoint has a limitation: I1 or I5 ports can not be selected to any output at the same time. **Busy** value of the switchable property refers to the limitation.

Request and Response

→ request-line: GET http://<ip>/api/V1/MEDIA/VIDEO/XP/<out>/SWITCHABLE/<in>
 → status-line: 200 OK
 → body: <switchable_state>

Parameters

Parameter	Parameter description	Values	Value description
<switchable_state>	The chosen input is can be switched to the output or not.	OK	The connection of the chosen input and output is allowed.
		Busy	The chosen input can not be switched to the output.
		Locked	The chosen input can not be switched to the output, because the input is locked.

Example

→ request-line: GET http://192.168.0.50/api/V1/MEDIA/VIDEO/XP/O2/SWITCHABLE/I1
 ← status-line: 200 OK
 ← body: Busy

7.6.11. Query the Video Signal Presence

Request and Response

→ request-line: GET http://<ip>/api/V1/MEDIA/VIDEO/<port>/SignalPresent
 → status-line: 200 OK
 → body: <state>

Parameters

Parameter	Parameter description	Values	Value description
<state>	This property gives a feedback about the current signal presence of the port.	true	The video signal is present.
		false	The video signal is not present.

Example

→ request-line: GET http://192.168.0.50/api/V1/MEDIA/VIDEO/I1/SignalPresent
 ← status-line: 200 OK
 ← body: true

7.6.12. HDCP Setting (Input Port)

HDCP capability can be set on the input ports, thus non-encrypted content can be seen on a non-HDCP compliant display. See more information in the [HDCP Management](#) section.

ATTENTION! HDCP 2.2 signal handling is limited to up to two input ports at the same time.

Request and Response #hdcp

→ request-line: POST http://<ip>/api/V1/MEDIA/VIDEO/<in>/HDCP/AllowedHdcpVersion
 → body: <allowed_hdcp>
 → status-line: 200 OK
 → body: <allowed_hdcp>

Parameters

Parameter	Parameter description	Values	Value description
<allowed_hdcp>	The input port reports the HDCP capability.	HDCP 1.4	The input port reports HDCP 1.4 capability.
		HDCP 2.2	The input port reports HDCP 2.2 capability.
		Off	The input port reports non-HDCP compliance.

Example

→ request-line: POST http://192.168.0.50/api/V1/MEDIA/VIDEO/I1/HDCP/AllowedHdcpVersion
 → body: HDCP 1.4
 ← status-line: 200 OK
 ← body: HDCP 1.4

7.6.13. HdcpMode

HDCP capability can be set to Auto/Always on the output ports, thus non-encrypted content can be transmitted to a non-HDCP compliant display. See more information in the [HDCP Management](#) section.

Request and Response #hdcp

→ request-line: POST http://<ip>/api/V1/MEDIA/VIDEO/<out>/HdcpMode
 → body: <hdcp_mode>
 → status-line: 200 OK
 → body: <hdcp_mode>

Parameters

Parameter	Parameter description	Values	Value description
<hdcp_mode>	HDCP encryption setting on the output port	Auto	The encryption is enabled on the output port if the signal on the input port is encrypted.
		Always	The outgoing signal is HDCP-encrypted.

Example

→ request-line: POST http://192.168.0.50/api/V1/MEDIA/VIDEO/01/HDCP/HdcpMode
 → body: Auto
 ← status-line: 200 OK
 ← body: Auto

7.6.14. Querying the Embedded Audio Presence

→ request-line: GET http://<ip>/api/V1/MEDIA/VIDEO/<port>/EmbeddedAudioPresent
 → status-line: 200 OK
 → body: <embedded_state>

Parameters

Parameter	Parameter description	Values	Value description
<embedded_state>	It shows if the video contains audio or not.	true	There is embedded audio in the video signal.
		false	There is no embedded audio in the video signal.

Example

→ request-line: GET http://192.168.0.50/api/V1/MEDIA/VIDEO/I2/EmbeddedAudioPresent
 ← status-line: 200 OK
 ← body: true

7.6.15. Muting the Embedded Audio

→ request-line: POST http://<ip>/api/V1/MEDIA/VIDEO/<port>/EmbeddedAudioMute
 → body: <mute_state>
 → status-line: 200 OK
 → body: <mute_state>

Parameters

Parameter	Parameter description	Values	Value description
<mute_state>	It shows if the embedded audio is muted or not.	true	The embedded audio is muted.
		false	The embedded audio is unmuted.

Example

→ request-line: POST http://192.168.0.50/api/V1/MEDIA/VIDEO/01/EmbeddedAudioMute
 → body: false
 ← status-line: 200 OK
 ← body: false

7.6.16. Setting the Output Signal Type**Request and Response** #signaltype

→ request-line: POST http://<ip>/api/V1/MEDIA/VIDEO/<out>/OutputSignalType
 → body: <signal_type>
 → status-line: 200 OK
 → body: <signal_type>

Parameters

Parameter	Parameter description	Values	Value description
<signal_type>	Signal type setting	Auto	The outgoing signal type is HDMI.
		DVI	The outgoing signal type is DVI.

Example

→ request-line: POST http://192.168.0.50/api/V1/MEDIA/VIDEO/01/OutputSignalType
 → body: Auto
 ← status-line: 200 OK
 ← body: Auto

7.6.17. Turning on Output 5V

The 5V power towards the sink can be enabled or disabled as follows:

Request and Response

→ request-line: POST http://<ip>/api/V1/MEDIA/VIDEO/<out>/Output5VMode
 → body: <5V_pwr>
 → status-line: 200 OK
 → body: <5V_pwr>

Parameters

Parameter	Parameter description	Value	Value description
<5V_pwr>	5V power towards the sink	On	Enable 5V power on HDMI port
		Off	Disable 5V power on HDMI port

Example

→ request-line: POST http://192.168.0.50/api/V1/MEDIA/VIDEO/01/Output5VMode
 → body: On
 ← status-line: 200 OK
 ← body: On

7.7. Welcome Screen Settings

For details about the Welcome screen feature, please see the [Welcome Screen](#) section.

7.7.1. Displaying the Welcome Screen Image

Request and Response *#welcomescreen*

→ request-line: POST·http://<ip>/api/V1/MEDIA/VIDEO/I5/WELCOMESCREEN/ImageEnabled
 → body: <image_state>

→ status-line: 200 OK
 → body: <image_state>

Parameters

Parameter	Values	Value description
<image_state>	true	The welcome screen image is displayed.
	false	The welcome screen image is not displayed.

Example

→ request-line: POST http://192.168.0.50/api/V1/MEDIA/VIDEO/I5/WELCOMESCREEN/ImageEnabled
 → body: true

← status-line: 200 OK
 ← body: true

7.7.2. Displaying the Welcome Screen Text

Request and Response

→ request-line: POST·http://<ip>/api/V1/MEDIA/VIDEO/I5/WELCOMESCREEN/MessageEnabled
 → body: <text_state>

→ status-line: 200 OK
 → body: <text_state>

Parameters

Parameter	Values	Value description
<text_state>	true	The welcome screen text is displayed.
	false	The welcome screen text is not displayed.

Example

→ request-line: POST http://192.168.0.50/api/V1/MEDIA/VIDEO/I5/WELCOMESCREEN/MessageEnabled
 → body: false

← status-line: 200 OK
 ← body: false

7.7.3. Setting the Welcome Screen Text

Request and Response

→ request-line: POST·http://<ip>/api/V1/MEDIA/VIDEO/I5/WELCOMESCREEN/MessageText
 → body: <text>

→ status-line: 200 OK
 → body: <text>

Parameters

The <text> may consist of letters (A-Z) and (a-z), hyphen (-), underscore (_), numbers (0-9), space () and dot (.). Max length: 63 characters. Longer names are truncated.

Example

→ request-line: POST http://192.168.0.50/api/V1/MEDIA/VIDEO/I5/WELCOMESCREEN/MessageText
 → body: helloworld

← status-line: 200 OK
 ← body: helloworld

7.7.4. Resetting the Welcome Screen Image

This command restores the original welcome screen image.

Request and Response

→ request-line: POST·http://<ip>/api/V1/MEDIA/VIDEO/I5/WELCOMESCREEN/resetImage

■ INFO: The body has to be empty, and the content type should be text/plain.

→ status-line: 200 OK

Example

→ request-line: POST http://192.168.0.50/api/V1/MEDIA/VIDEO/I5/WELCOMESCREEN/resetImage
 ← status-line: 200 OK

7.8. Video Port Settings - USB-C Related Commands

7.8.1. Restarting the Link Training

This method is equal to pulling the USB-C connector out and plugging it in again.

Request and Response *#linktraining*

→ request-line: POST·http://<ip>/api/V1/MEDIA/VIDEO/<in>/DP/restartLinkTraining

■ INFO: The body has to be empty, and the content type should be text/plain.

→ status-line: 200 OK

Example

→ request-line: POST http://192.168.0.50/api/V1/MEDIA/VIDEO/I1/DP/restartLinkTraining
 ← status-line: 200 OK

7.9. CEC Command Sending

DIFFERENCE: This feature and the commands below are available from FW package v1.4.0b4.

The device is able to send Consumer Electronics Control (CEC) commands. This feature is for remote controlling the source or sink device. CEC is a bi-directional communication via the HDMI cable.

ATTENTION! To have a successful CEC command processing, the connected HDMI device must support CEC. #cec

7.9.1. Simple CEC Code Sending

This command is for sending simple CEC commands to the connected sink device. In this case the <command> is sent in a CEC frame without any opcode. The command also allows sending many commands at once.

The commands can be sent by the following two formats – defined in the header:

- **text/plain:** hexa strings (as seen in the example)
- **application/octet-stream:** binary data that allows sending a file with the desired codes

Request and Response

→ request-line: POST·http://<ip>/api/V1/MEDIA/VIDEO/<port>/CEC/send
 → body: <command>
 → status-line: 200 OK
 → body: <response>

Parameters

Parameter	Parameter description	Values	Value description
<port>	Video output port	01-02*	Video output port number
<command> **	Two-digit-long hexa code to control the sink device	04	Power on
		0D	Power off
		36	Standby
		821000	Select input 1
		822000	Select input 2
		823000	Select input 3

* It depends on the capabilities of the UCX device.

** The supported list of <commands> depends on the connected sink device.

The <response> can be:

<response>	HTTP code	Result
ACK	200	The transmission is successful
NACK	444	The command is not accepted
Timeout	408	Timeout
Internal Error	500	Other error

Example

→ request-line: POST·http://192.168.1.9/api/V1/MEDIA/VIDEO/01/CEC/send
 → body: 04
 ← status-line: 200 OK
 ← body: ACK

7.9.2. Remote Control Code Sending

This command is for sending the so-called 'push-button-commands'. There is a range within the CEC commands for this purpose, e.g. volume up/down. With this method one <command> is put between the 0x44 and 0x45 opcodes in the background.

Request and Response

→ request-line: POST·http://<ip>/api/V1/MEDIA/VIDEO/<port>/CEC/sendUserControlClick
 → body: <command>
 → status-line: 200 OK
 → body: <response>

Parameters

Parameter	Parameter description	Values	Value description
<port>	Video output port	01-02*	Video output port number
<command> **	Two-digit-long hexa code to control the sink device	6D	Power on
		6C	Power off

* It depends on the capabilities of the UCX device.

** The supported list of <commands> depends on the connected sink device.

The <response> can be the same as written at the previous command.

Example

→ request-line: POST·http://192.168.1.9/api/V1/MEDIA/VIDEO/01/CEC/sendUserControlClick
 → body: 6D
 ← status-line: 200 OK
 ← body: ACK

7.10. Audio Port Settings

INFO: Audio port numbers may differ depending on the model. For more information, see the [Port Numbering](#) section.

7.10.1. Switching the Audio Input

Request and Response

→ request-line: POST http://<ip>/api/V1/MEDIA/AUDIO/XP/switch
 → body: <audio_in>:03
 → status-line: 200 OK
 → body: <audio_in>:03

Parameters

Parameter	Parameter description	Values	Value description
<audio_in>	Audio input port	I1-I4	Audio input port number

Example

→ request-line: POST http://192.168.0.50/api/V1/MEDIA/AUDIO/XP/switch
 → body: I2:03
 ← status-line: 200 OK
 ← body: I2:03

INFO: When using the '0' value as an input, the input will be disconnected and no signal will appear on the output.

ATTENTION! When I5 is selected for video source, the de-embedded audio of the I1 is not available, because the video crosspoint has a limitation: I1 and I5 ports are not available at the same time, only one of them can be selected to any output. For more details about it, see the port diagram in the [Audio Interface](#) section.

7.10.2. Querying the Connected Source

Request and Response

→ request-line: GET http://<ip>/api/V1/MEDIA/AUDIO/XP/03/ConnectedSource
 → status-line: 200-OK
 → body: <audio_in>

Parameters

Parameter	Parameter description	Values	Value description
<audio_in>	Audio input port	I1-I4	Audio input port number

Example

→ request-line: GET http://192.168.0.50/api/V1/MEDIA/AUDIO/XP/03/ConnectedSource
 ← status-line: 200 OK
 ← body: I2

7.10.3. Querying the Connected Destinations

Request and Response

→ request-line: GET http://<ip>/api/V1/MEDIA/AUDIO/XP/<audio_in>/ConnectedDestinations
 → status-line: 200-OK
 → body: <audio_out>

Parameters

Parameter	Parameter description	Values	Value description
<audio_in>	Audio input port	I1-I4	Audio input port number
<audio_out>	Audio output port	O3	Audio output port number

Example

→ request-line: GET http://192.168.0.50/api/V1/MEDIA/AUDIO/XP/I3/ConnectedDestinations
 ← status-line: 200 OK
 ← body: O3

7.10.4. Setting the Autoselect Operation Mode

Request and Response

- request-line: POST-http://<ip>/api/V1/MEDIA/AUDIO/AUTOSELECT/O3/Policy
- body: <op_mode>
- status-line: 200 OK
- body: <op_mode>

Parameters

Parameter	Parameter description	Values	Value description
<op_mode>	Operation mode	Follow video	Follows the video crosspoint state automatically.
		Off	Autoselect function is disabled.

Example

- request-line: POST http://192.168.0.50/api/V1/MEDIA/AUDIO/AUTOSELECT/O3/Policy
- body: Follow video
- ← status-line: 200 OK
- ← body: Follow video

7.10.5. Setting the Followed Video Port to Autoselect

Request and Response

- request-line: POST-http://<ip>/api/V1/MEDIA/AUDIO/AUTOSELECT/O3/VideoFollowPort
- body: <out>
- status-line: 200 OK
- body: <out>

Example

- request-line: POST http://192.168.0.50/api/V1/MEDIA/AUDIO/AUTOSELECT/O3/VideoFollowPort
- body: 01
- ← status-line: 200 OK
- ← body: 01

7.10.6. Enabling/Disabling the Dante USB Sound Card

DIFFERENCE: This command is only available for the UCX-4x3-HC40-BD model.

This command enables or disables the Dante USB Sound Card, toggling the Dante input functionality. When enabled, the Dante audio input devices will appear as USB audio inputs on the host computer.

INFO: Dante input devices can only be detected by the computer when the USB sound card is enabled.

Request and Response

- request-line: POST /V1/SYS/BD_DANTE_ADDON/Enabled
- body: <status>
- status-line: 200 OK
- body: <status>

Parameters

Parameter	Parameter description	Values
<status>	Enables or disables the USB sound card. Default value is true .	true
		false

Example

- request-line: POST /V1/SYS/BD_DANTE_ADDON/Enabled
- body: true
- ← request-line: 200 OK
- ← body: true

7.10.7. Setting the Audio Device Type for the Dante Input

DIFFERENCE: This command is only available for the UCX-4x3-HC40-BD model.

This command allows setting the type of audio input device through the Dante channel.

Request and Response

- request-line: POST /V1/MEDIA/AUDIO/DANTE_IN/AudioDeviceType
- body: <device_type>
- request-line: 200 OK
- body: <device_type>

Parameters

Parameter	Parameter description	Values
<device_type>	Sets the type of the audio input device	Speakerphone
		Echo-canceling speakerphone
		Echo-suppressing speakerphone

Example

- request-line: POST /V1/MEDIA/AUDIO/DANTE_IN/AudioDeviceType
- body: Echo-canceling speakerphone
- ← request-line: 200 OK
- ← body: Echo-canceling speakerphone

7.10.8. Locking the Audio Port

Request and Response

→ request-line: POST http://<ip>/api/V1/MEDIA/AUDIO/XP/<audio_port>/Lock
 → body: <locked_state>
 → status-line: 200 OK
 → body: <locked_state>

Parameters

Parameter	Parameter description	Values	Value description
<audio_port>	Audio port	I1-I4 O3	Audio input port number Audio output port number
<locked_state>	Locked state	true false	The port is locked The port is unlocked

Example

→ request-line: POST http://192.168.0.50/api/V1/MEDIA/AUDIO/XP/I2/Lock
 → body: false
 ← status-line: 200 OK
 ← body: false

7.10.9. Muting the Audio Port 1.

INFO: Suspends the connection of the chosen port (no signal is forwarded).

Request and Response

→ request-line: POST http://<ip>/api/V1/MEDIA/AUDIO/XP/<audio_port>/Mute
 → body: <muted_state>
 → status-line: 200 OK
 → body: <muted_state>

Parameters

Parameter	Parameter description	Values	Value description
<audio_port>	Audio port	I1-I4 O3	Audio input port number Audio output port number
<muted_state>	Muted state	true false	The port is muted. The port is unmuted.

Example

→ request-line: POST http://192.168.0.50/api/V1/MEDIA/AUDIO/XP/I2/Mute
 → body: false
 ← status-line: 200 OK
 ← body: false

INFO: All inputs and analog output ports have a mute property in the audio XP (e.g. http://<ip>/api/V1/MEDIA/AUDIO/XP/I1.Mute). Outputs have a separate mute function within the port node as well:

- http://<ip>/api/V1/MEDIA/VIDEO/XP/O1.EmbeddedAudioMute
- http://<ip>/api/V1/MEDIA/VIDEO/XP/O2.EmbeddedAudioMute
- http://<ip>/api/V1/MEDIA/AUDIO/O3.Mute

7.10.10. Muting the Audio Port 2.

INFO: The volume of the analog audio output is set to low.

Request and Response

→ request-line: POST-http://<ip>/api/V1/MEDIA/AUDIO/O3/Mute
 → body: <muted_state>
 → status-line: 200 OK
 → body: <muted_state>

Parameters

Parameter	Parameter description	Values	Value description
<audio_port>	Audio port	I1-I4 O3	Audio input port number Audio output port number
<muted_state>	Muted state	true false	The port is muted. The port is unmuted.

Example

→ request-line: POST http://192.168.0.50/api/V1/MEDIA/AUDIO/O3/Mute
 → body: false
 ← status-line: 200 OK
 ← body: false

7.10.11. Querying the Audio Signal Presence

Request and Response

→ request-line: GET-http://<ip>/api/V1/MEDIA/AUDIO/<audio_port>/SignalPresent
 → status-line: 200 OK
 → body: <signal_state>

Parameters

Parameter	Parameter description	Values	Value description
<audio_port>	Audio port	I1-I4 O3	Audio input port number Audio output port number
<signal_state>	Signal presence	true false	The audio signal is present. No audio signal is present.

Example

→ request-line: GET http://192.168.0.50/api/V1/MEDIA/AUDIO/I1/SignalPresent
 ← status-line: 200 OK
 ← body: false

7.10.12. Analog Audio Output Volume (dB) Setting

Request and Response #analogaudio #volume

→ request-line: POST-http://<ip>/api/V1/MEDIA/AUDIO/O3/VoluedB
 → body: <level>
 → status-line: 200 OK
 → body: <level>

Parameter

The <level> parameter sets the output volume (attenuation) between -95.62 dB and 0 dB in step of -0.375 dB. The value is rounded up if necessary, to match with the step value.

Example

→ request-line: POST http://192.168.0.50/api/V1/MEDIA/AUDIO/O3/VoluedB
 → body: -15
 ← status-line: 200 OK
 ← body: -15

7.10.13. Analog Audio Output Volume Percent Setting

Request and Response

→ request-line: POST-http://<ip>/api/V1/MEDIA/AUDIO/O3/VolumePercent
 → body: <percent>
 → status-line: 200 OK
 → body: <percent>

Parameters

The <percent> parameter sets the output volume (attenuation) between 100% and 0%, in step of 1%. The value is rounded up if necessary, to match with the step value.

Example

→ request-line: POST http://192.168.0.50/api/V1/MEDIA/AUDIO/O3/VolumePercent
 → body: 50
 ← status-line: 200 OK
 ← body: 50

7.10.14. Setting the Balance

Request and Response *#balance*

- request-line: POST http://<ip>/api/V1/MEDIA/AUDIO/O3/Balance
- body: <level>
- status-line: 200 OK
- body: <level>

Parameters

The <level> parameter sets the balance; -100 means left balance, 100 means right balance, step is 1. Center is 0 (default).

Example

- request-line: POST http://192.168.0.50/api/V1/MEDIA/AUDIO/O3/Balance
- body: 0
- ← status-line: 200 OK
- ← body: 0

7.10.15. Analog Audio Output Level Setting by Steps (dB)

Request and Response *#analogaudio #volume*

- request-line: POST http://<ip>/api/V1/MEDIA/AUDIO/O3/stepVolumedB
- body: <step>
- status-line: 200 OK
- body: <step>

Parameters

The volume is increased or decreased with the given <step> value in dB.

Example

- request-line: POST http://192.168.0.50/api/V1/MEDIA/AUDIO/O3/stepVolumedB
- body: -1
- ← status-line: 200 OK
- ← body: OK

The volume is decreased with 1 dB, the current volume is -1.95 dB, which means 77.84% in percent.

7.10.16. Analog Audio Output Level Setting by Steps in Percent

Request and Response

- request-line: POST http://<ip>/api/V1/MEDIA/AUDIO/O3/stepVolumePercent
- body: <step>
- status-line: 200 OK
- body: <step>

Parameters

The volume is increased or decreased by the given <step> value in percent.

Example

- request-line: POST http://192.168.0.50/api/V1/MEDIA/AUDIO/O3/stepVolumePercent
- body: 5
- ← status-line: 200 OK
- ← body: OK

7.10.17. Analog Audio Output Balance Setting by Steps

Request and Response

- request-line: POST http://<ip>/api/V1/MEDIA/AUDIO/O3/stepBalance
- body: <step>
- status-line: 200 OK
- body: <step>

Parameters

The volume is increased or decreased by the given <step> value.

Example

- request-line: POST http://192.168.0.50/api/V1/MEDIA/AUDIO/O3/stepBalance
- body: 5
- ← status-line: 200 OK
- ← body: OK

7.11. USB Port Settings

INFO: USB port numbers may differ depending on the model. For more information, see the [Port Numbering](#) section.

7.11.1. Switching the USB Input

Request and Response *#usb*

→ request-line: POST-http://<ip>/api/V1/MEDIA/USB/XP/switch
 → body: <host>:H1
 → status-line: 200 OK
 → body: <host>:H1

Parameters

Parameter	Parameter description	Values	Value description
<host>	USB Host	0 U1-U4	Disconnected USB-C and USB-B port number

Example

→ request-line: POST http://192.168.0.50/api/V1/MEDIA/USB/XP/switch
 → body: U1:H1
 ← status-line: 200 OK
 ← body: OK

INFO: When using the '0' value as an input, the input will be disconnected and no signal will appear on the output.

7.11.2. Querying the Connected Source

Request and Response

→ request-line: GET-http://<ip>/api/V1/MEDIA/USB/XP/H1/ConnectedSource
 → status-line: 200 OK
 → body: <host>

Parameters

Parameter	Parameter description	Values	Value description
<host>	USB Host	U1-U4	USB-C and USB-B port number

Example

→ request-line: GET http://192.168.0.50/api/V1/MEDIA/USB/XP/H1/ConnectedSource
 ← status-line: 200 OK
 ← body: U4

7.11.3. Querying the Connected Destinations

Request and Response *#autoselect*

→ request-line: GET-http://<ip>/api/V1/MEDIA/USB/XP/<host>/ConnectedDestinations
 → status-line: 200 OK
 → body: <host>

Parameters

Parameter	Parameter description	Values	Value description
<host>	USB Host	U1-U4	USB-C and USB-B port number

Example

→ request-line: GET http://192.168.0.50/api/V1/MEDIA/USB/XP/U3/ConnectedDestinations
 ← status-line: 200 OK
 ← body: H1

7.11.4. Locking the USB Port

Request and Response *#lock*

→ request-line: POST-http://<ip>/api/V1/MEDIA/USB/XP/<usb_port>/Lock
 → body: <locked_state>
 → status-line: 200 OK
 → body: <locked_state>

Parameters

Parameter	Parameter description	Values	Value description
<usb_port>	USB port	U1-U4 H1	USB-C and USB-B port number USB hub
<locked_state>	Locked state	true false	The port is locked The port is unlocked

Example

→ request-line: POST http://192.168.0.50/api/V1/MEDIA/USB/XP/U2/Lock
 → body: false
 ← status-line: 200 OK
 ← body: false

7.11.5. Setting the 5V Sending to the USB Peripherals

The 5V power towards the USB A-type ports can be enabled or disabled as follows:

Request and Response

→ request-line: POST http://<ip>/api/V1/MEDIA/USB/H1/<device_id>/Power5VMode
 → body: <device_pwr>
 → status-line: 200 OK
 → body: <device_pwr>

Parameters

Parameter	Parameter description	Values	Value description
<device_id>	USB A-type port	D1-D4	Downstream port number
<device_pwr>	5V power sending	Auto	The host controls the 5V power sending.
		Off	Disable 5V power on USB downstream port

Example

→ request-line: POST http://192.168.0.50/api/V1/MEDIA/USB/H1/D1/Power5VMode
 → body: Auto
 ← status-line: 200 OK
 ← body: Auto

7.11.6. Setting the USB Autoselect Policy

Request and Response

→ request-line: POST http://<ip>/api/V1/MEDIA/USB/AUTOSELECT/H1/Policy
 → body: <op_mode>
 → status-line: 200 OK
 → body: <op_mode>

Parameters

Parameter	Parameter description	Values	Value description
<op_mode>	Operation mode	Off	The autoselect function is disabled.
		Last Detect	It is always the last attached input that is automatically switched to the output.
		First Detect	The first active USB input is selected.
		Follow video	Follows the video crosspoint state automatically.

Example

→ request-line: POST http://192.168.0.50/api/V1/MEDIA/USB/AUTOSELECT/H1/Policy
 → body: Follow video
 ← status-line: 200 OK
 ← body: Follow video

7.11.7. Setting the Followed Video Port to Autoselect

Request and Response

→ request-line: POST http://<ip>/api/V1/MEDIA/USB/AUTOSELECT/H1/VideoFollowPort
 → body: <out>
 → status-line: 200 OK
 → body: <out>

Example

→ request-line: POST http://192.168.0.50/api/V1/MEDIA/USB/AUTOSELECT/H1/VideoFollowPort
 → body: 01
 ← status-line: 200 OK
 ← body: 01

7.11.8. Changing the Autoselect Included USB Ports

Request and Response

→ request-line: POST http://<ip>/api/V1/MEDIA/USB/AUTOSELECT/H1/<host>/Included
 → body: <state>
 → status-line: 200 OK
 → body: <state>

Parameters

Parameter	Parameter description	Values	Value description
<host>	USB Host	U1-U4	USB-C and USB-B port number
<state>	The chosen input is ignored in the autoselect process or not.	true	The port is included in autoselect.
		false	The autoselect function ignores that port.

Example

→ request-line: POST http://192.168.0.50/api/V1/MEDIA/USB/AUTOSELECT/H1/U1/Included
 → body: false
 ← status-line: 200 OK
 ← body: false

7.11.9. Changing the USB Port Priority

DIFFERENCE: This command is available only from FW package v1.1.0b7.

Request and Response

- request-line: POST-http://<ip>/api/V1/MEDIA/USB/AUTOSELECT/H1/<host>/Priority
- body: <prio_num>
- status-line: 200 OK
- body: <prio_num>

Parameters

Parameter	Parameter description	Values	Value description
<host>	USB Host	U1-U4	USB-C and USB-B port number
<prio_num>	Priority number from 1 to 100, equal numbers are allowed.	1-100	1: the highest priority 100: the lowest priority

Example

- request-line: POST http://192.168.0.50/api/V1/MEDIA/USB/AUTOSELECT/H1/U1/Priority
- body: 51
- ← status-line: 200 OK
- ← body: 51

7.12. USB Port Settings - USB-C Related Commands

INFO: USB-C port numbers may differ depending on the model. For more information, see the [Port Numbering](#) section.

7.12.1. Setting the USB-C Power

Request and Response #power

- request-line: POST-http://<ip>/api/V1/SYS/MB/USBCPOWER/PowerLimit
- body: <power>
- status-line: 200 OK
- body: <power>

Parameters

Parameter	Parameter description	Values	Value description
<power>	Power limit to the USB-C ports	0 1 2	Equal output power on the two ports (30W each) Port1 maximum, Port2 minimum (60W for U1) Port1 minimum, Port2 maximum (60W for U2)

Example

- request-line: POST http://192.168.0.50/api/V1/SYS/MB/USBCPOWER/PowerLimit
- body: 2

- ← status-line: 200 OK
- ← body: 2

7.12.2. Setting the Displayport Alternate Mode Policy

Request and Response

- request-line: POST-http://<ip>/api/V1/MEDIA/USB/<usb-c_port>/DpAltModePolicy
- body: <dp_policy>
- status-line: 200 OK
- body: <dp_policy>

Parameters

Parameter	Parameter description	Values	Value description
<usb-c_port>	USB-C port number	U1-U2	USB-C port number
<dp_policy>	The preferred video or USB data transmission	Auto Force C Force D	Auto: Taurus offers both operation modes described below. A BYOD device can choose between the two. Neither USB3, nor 4 lane DP Alt mode operation (4K@60) is guaranteed. BYOD devices supporting USB3.x usually choose shared mode: USB3.1 and 2 lane DP. Force C: Prefer video: all four lanes are reserved for video transmission, USB 3.1 data transmission does not operate. Force D: Prefer USB 3.1: 2 lanes are reserved for USB 3.1, 2 lanes for video.

Example

- request-line: POST http://192.168.0.50/api/V1/MEDIA/USB/U2/DpAltModePolicy
- body: Auto
- ← status-line: 200 OK
- ← body: Auto

ATTENTION! Changing DpAltModePolicy is recommended before connecting a computer to the input.

7.12.3. Querying the Host Alternate Mode Support

Request and Response

- ➔ request-line: GET http://<ip>/api/V1/MEDIA/USB/<usb-c_port>/HostSupportsDpAltMode
- ➔ status-line: 200-OK
- ➔ body: <altmode_support>

Parameters

Parameter	Parameter description	Value	Value description
<usb-c_port>	USB-C port number	U1-U2	USB-C port number
<altmode_support>		False	The host does not support the alternate mode.
		True	The host supports the alternate mode.

Example

- ➔ request-line: GET http://192.168.0.50/api/V1/MEDIA/USB/U1/HostSupportsDpAltMode
- ⬅ status-line: 200 OK
- ⬅ body: true

7.12.4. Querying the Status of the Alternate Mode

Request and Response *#dpaltmode #alternatemode #displayportalternatemode*

- ➔ request-line: GET http://<ip>/api/V1/MEDIA/USB/<usb-c_port>/ActiveAltMode
- ➔ status-line: 200-OK
- ➔ body: <altmode_state>

Parameters

Parameter	Parameter description	Value	Value description
<usb-c_port>	USB-C port number	U1-U2	USB-C port number
<altmode_state>		N/A	The host is not connected
		None	DP Alt mode is not active
		DP	DP Alt mode is active.

Example

- ➔ request-line: GET http://192.168.0.50/api/V1/MEDIA/USB/U2/ActiveAltMode
- ⬅ status-line: 200 OK
- ⬅ body: DP

7.12.5. Querying the Port Data Role

Request and Response

- ➔ request-line: GET http://<ip>/api/V1/MEDIA/USB/<usb-c_port>/ActivePortDataRole
- ➔ status-line: 200-OK
- ➔ body: <data_role>

Parameters

Parameter	Parameter description	Values	Value description
<usb-c_port>	USB-C port number	U1-U2	USB-C port number
<data_role>		N/A	No information about the data role.
		DFP	Downstream Facing Port (usually a Host / HUB ports) The port data role is configured as USB Host. This is for building up the connection (USB data transmission operates after the data role swap)
		UFP	Upstream Facing Port (usually a device)

Example

- ➔ request-line: GET http://192.168.0.50/api/V1/MEDIA/USB/U2/ActivePortDataRole
- ⬅ status-line: 200 OK
- ⬅ body: UFP

7.12.6. Querying the Port Power Role

Request and Response *#power*

- ➔ request-line: GET http://<ip>/api/V1/MEDIA/USB/<usb-c_port>/ActivePortPowerRole
- ➔ status-line: 200-OK
- ➔ body: <power_role>

Parameters

Parameter	Parameter description	Values	Value description
<usb-c_port>	USB-C port number	U1-U2	USB-C port number
<power_role>		N/A	No information about the power role.
		Sink	The port is configured as a sink.
		Source	The port is configured as a source

Example

- ➔ request-line: GET http://192.168.0.50/api/V1/MEDIA/USB/U2/ActivePortPowerRole
- ⬅ status-line: 200 OK
- ⬅ body: Source

7.12.7. Setting the Port Power Role

Request and Response

- request-line: POST http://<ip>/api/V1/MEDIA/USB/<usb-c_port>/PortPowerRoleSetting
- body: <power_role>
- status-line: 200 OK
- body: <power_role>

Parameters

Parameter	Parameter description	Values	Value description
<usb-c_port>	USB-C port number	U1-U2	USB-C port number
<power_role>		Sink	The port is configured as a sink.
		Source	The port is configured as a source.
		Dual Role	The port is configured to be in Dual Power Role mode.

Example

- request-line: POST http://192.168.0.50/api/V1/MEDIA/USB/U1/PortPowerRoleSetting
- body: Dual Role
- ← status-line: 200 OK
- ← body: Dual Role

7.13. EDID Management

7.13.1. Querying the Emulated EDIDs

Request and Response #edid

- request-line: GET http://<ip>/api/V1/EDID/EdidStatus
- status-line: 200 OK
- body: ["<source>:E1";"<source>:E2";" <source>:E3;"<source>:E4"]

Parameters

Parameter	Parameter description	Values	Value description
<source>	Source EDID memory place	F1-F120	Factory EDIDs
		U1-U14	User EDIDs
		D1-D2	Dynamic EDIDs

Example

- request-line: GET http://192.168.0.50/api/V1/EDID/EdidStatus
- ← status-line: 200 OK
- ← body: ["F47:E1","F47:E2","F47:E3","F47:E4"]

Emulated EDID memory for input port is listed with the EDID number that is currently emulated on the input.

7.13.2. Querying the Validity of a Dynamic EDID

Request and Response

- request-line: GET http://<ip>/api/V1/EDID/D/D1/Validity
- status-line: 200 OK
- body: <validity>

Parameters

If the <validity> parameter is **true**, the EDID is valid. If the parameter is **false**, the EDID is invalid.

Example

- request-line: GET http://192.168.0.50/api/V1/EDID/D/D1/Validity
- ← status-line: 200 OK
- ← body: true

The 'Validity' property is true, valid EDID is stored in D1 memory place.

7.13.3. Querying the Preferred Resolution of a User EDID

Request and Response

- request-line: GET http://<ip>/api/V1/EDID/U/<user_edid>/PreferredResolution
- status-line: 200 OK
- body: <preferred_resolution>

Example

- request-line: GET http://192.168.0.50/api/V1/EDID/U/U2/PreferredResolution
- ← status-line: 200 OK
- ← body: 1920x1080p60.00Hz

INFO: Use the **Manufacturer** and **MonitorName** properties to query further information.

7.13.4. Emulating an EDID to an Input Port

Request and Response

- request-line: POST http://<ip>/api/V1/EDID/switch
- body: <source>:<destination>
- status-line: 200 OK
- body: <source>:<destination>

Parameters

Parameter	Parameter description	Values	Value description
<source>	Source EDID memory place	F1-F120	Factory EDIDs
		U1-U14	User EDIDs
		D1-D2	Dynamic EDIDs
<destination>	The emulated EDID memory of the desired input port	U1-U14	User EDIDs

Example

- request-line: POST http://192.168.0.50/api/V1/EDID/switch
- body: F49:E2
- ← status-line: 200 OK
- ← body: OK

7.13.5. Emulating an EDID to All Input Ports

Request and Response

- request-line: POST http://<ip>/api/V1/EDID/switchAll
- body: <source>
- status-line: 200 OK
- body: OK

Parameters

Parameter	Parameter description	Values	Value description
<source>	Source EDID memory place	F1-F148	Factory EDIDs
		U1-U100	User EDIDs
		D1-D2	Dynamic EDIDs

Example

- request-line: POST http://192.168.0.50/api/V1/EDID/switchAll
- body: F47
- ← status-line: 200 OK
- ← body: OK

7.13.6. Copying an EDID to User Memory

Request and Response

- request-line: POST http://<ip>/api/V1/EDID/copy
- body: <source>:<destination>
- status-line: 200 OK
- body: OK

Parameters

Parameter	Parameter description	Values	Value description
<source>	Source EDID memory place	F1-F148	Factory EDIDs
		U1-U100	User EDIDs
		D1-D2	Dynamic EDIDs
<destination>	The emulated EDID memory of the desired input port	U1-U100	User EDIDs

Example

- request-line: POST http://192.168.0.50/api/V1/EDID/copy
- body: F1:U2
- ← status-line: 200 OK
- ← body: OK

7.13.7. Deleting an EDID from User Memory

Request and Response

- request-line: POST http://<ip>/api/V1/EDID/delete
- body: <user_edid>
- status-line: 200 OK
- body: OK

Parameters

Parameter	Parameter description	Values	Value description
<user_edid>	The emulated EDID memory of the desired input port.	U1-U14	User EDIDs

Example

- request-line: POST http://192.168.0.50/api/V1/EDID/delete
- body: U2
- ← status-line: 200 OK
- ← body: OK

7.13.8. Resetting the Emulated EDIDs

Request and Response

→ request-line: POST http://<ip>/api/V1/EDID/reset

INFO: The body has to be empty, and the content type should be text/plain.

→ status-line: 200 OK

→ body: OK

Example

→ request-line: POST http://192.168.0.50/api/V1/EDID/reset

← status-line: 200 OK

← body: OK

Calling this method switches all emulated EDIDs to a factory default one. See the table in the [Factory EDID List](#) section.

7.14. Ethernet Port Configuration

7.14.1. Setting the DHCP State

ATTENTION! When you change a network property, the new value is stored, but the **applySettings** method must always be called to apply the new settings. When two or more network parameters are changed, the **applySettings** method is enough to be called once as a final step.

Request and Response #dhcp #network #ipaddress

→ request-line: POST http://<ip>/api/V1/MANAGEMENT/NETWORK/DhcpEnabled

→ body: <dhcp_status>

→ status-line: 200 OK

→ body: <dhcp_status>

Parameters

If the <dhcp_status> parameter is **true**, the current IP address setting is DHCP, if the parameter is **false**, the current IP address is static.

Example

→ request-line: POST http://192.168.0.50/api/V1/MANAGEMENT/NETWORK/DhcpEnabled

→ body: true

← status-line: 200 OK

← body: true

→ request-line: POST http://192.168.0.50/api/V1/MANAGEMENT/NETWORK/applySettings

← status-line: 200 OK

← body: OK

INFO: The **applySettings** method will save and apply the new value and it will reboot the device.

INFO: The current setting can be queried by using the [GET Method](#).

7.14.2. Changing the IP Address (Static)

Request and Response

→ request-line: POST http://<ip>/api/V1/MANAGEMENT/NETWORK/StaticIpAddress

→ body: <IP_address>

→ status-line: 200 OK

→ body: <IP_address>

Example

→ request-line: POST http://192.168.0.50/api/V1/MANAGEMENT/NETWORK/StaticIpAddress

→ body: 192.168.0.100

← status-line: 200 OK

← body: 192.168.0.100

→ request-line: POST http://192.168.0.50/api/V1/MANAGEMENT/NETWORK/applySettings

← status-line: 200 OK

← body: OK

INFO: The **applySettings** method saves and applies the new value and it will reboot the device.

INFO: The current setting can be queried by using the [GET Method](#).

7.14.3. Changing the Subnet Mask (Static)

Request and Response *#ipaddress*

- request-line: POST http://<ip>/api/V1/MANAGEMENT/NETWORK/StaticNetworkMask
- body: <netmask>
- status-line: 200 OK
- body: <netmask>

Example

- request-line: POST http://192.168.0.50/api/V1/MANAGEMENT/NETWORK/StaticNetworkMask
- body: 255.255.255.0
- ← status-line: 200 OK
- ← body: 255.255.255.0
- request-line: POST http://192.168.0.50/api/V1/MANAGEMENT/NETWORK/applySettings
- ← status-line: 200 OK
- ← body: OK

INFO: The **applySettings** method will save and apply the new value and it will reboot the device.

INFO: The current setting can be queried by using the [GET Method](#).

7.14.4. Changing the Gateway Address (Static)

Request and Response

- request-line: POST http://<ip>/api/V1/MANAGEMENT/NETWORK/StaticGatewayAddress
- body: <gw_address>
- status-line: 200 OK
- body: <gw_address>

Example

- request-line: POST http://192.168.0.50/api/V1/MANAGEMENT/NETWORK/StaticGatewayAddress
- body: 192.168.0.1
- ← status-line: 200 OK
- ← body: 192.168.0.1
- request-line: POST http://192.168.0.50/api/V1/MANAGEMENT/NETWORK/applySettings
- ← status-line: 200 OK
- ← body: OK

INFO: The **applySettings** method will save and apply the new value and it will reboot the device.

INFO: The current setting can be queried by using the [GET Method](#).

7.14.5. Applying the Network Settings

Request and Response

- request-line: POST http://<ip>/api/V1/MANAGEMENT/NETWORK/applySettings
- INFO: The body has to be empty, and the content type should be text/plain.
- status-line: 200 OK
- body: OK

Example

- request-line: POST http://192.168.0.50/api/V1/MANAGEMENT/NETWORK/applySettings
- ← status-line: 200 OK
- ← body: OK

All network settings that were changed are applied and network interface restarts.

7.14.6. Setting the Hostname

The host name is a property that can be used instead of the IP address when connecting to the device. It is also suitable for finding the device in the Device Discovery window of the LDC, see more details in the [Add New Favorite Device](#) section. Furthermore, it can be used to open the The Built-in Miniweb. If the IP address of the device is changing, the host name can be used as a fixed property.

After hostname changing, restarting the network services is required. New SSL certificate will be generated.

Request and Response

- request-line: POST http://<ip>/api/V1/MANAGEMENT/NETWORK/HostName
- body: <unique_name>
- status-line: 200 OK
- body: <unique_name>

Parameters

The <unique_name> can be 1-64 character(s) long and the following are allowed for naming: the elements of the English alphabet and numbers. Hyphen (-) and dot (.) are also accepted, except as last character.

Example

- request-line: POST http://192.168.0.50/api/V1/MANAGEMENT/NETWORK/HostName
- body: room-switcher
- ← status-line: 200 OK
- ← body: room-switcher

7.15. Network Security

7.15.1. Enabling/Disabling the Ethernet Port

Request and Response

- ➔ request-line: POST http://<ip>/api/V1/MEDIA/ETHERNET/<ethernet_port>/Enabled
- ➔ body: <status>
- ➔ status-line: 200 OK
- ➔ body: <status>

Parameters

Identifier	Parameter description	Parameter values
<ethernet_port>	Ethernet port number	P1-P5*
<status>	The port is disabled.	false
	The port is enabled.	true

*The UCX-2x1-HC30 and UCX-2x1-HC40 model has three Ethernet ports (P1-P3).

Example

- ➔ request-line: POST http://192.168.0.50/api/V1/MEDIA/ETHERNET/P4/Enabled
- ➔ body: false
- ⬅ status-line: 200 OK
- ⬅ body: false

DIFFERENCE: From firmware version v2.9.0, disabling the Ethernet port will cause the USB connection to restart on the corresponding USB-C port in HW versions below v5.0

7.15.2. Querying the Network Service Port Number

Request and Response *#http #https*

- ➔ request-line: GET http://<ip>/api/V1/MANAGEMENT/NETWORK/SERVICES/<port>/Port
- ➔ status-line: 200 OK
- ➔ body: <port_num>

Parameters

Identifier	Parameter description	Parameter values
<port>	Port type	HTTP / HTTPS / LW3 / SERIAL1 / SERIAL2
<port_num>	Port number	80 / 443 / 6107 / 8001 / 8002

Example

- ➔ request-line: GET http://192.168.0.50/api/V1/MANAGEMENT/NETWORK/SERVICES/HTTP/Port
- ⬅ status-line: 200 OK
- ⬅ body: 80

7.15.3. Enabling/Disabling the Network Service Port

Request and Response

- ➔ request-line: GET http://<ip>/api/V1/MANAGEMENT/NETWORK/SERVICES/<port>/Enabled
- ➔ body: <status>
- ➔ status-line: 200 OK
- ➔ body: <status>

Parameters

Identifier	Parameter description	Parameter values
<port>	Port type	HTTP / HTTPS
<status>	The port is enabled.	true
	The port is disabled.	false

Example

- ➔ request-line: POST http://192.168.0.50/api/V1/MANAGEMENT/NETWORK/SERVICES/HTTP/Enabled
- ➔ body: false
- ⬅ status-line: 200 OK
- ⬅ body: false

7.15.4. Querying the Username for Authentication

INFO: UCX series deal with one user for authentication and the username (admin) can not be changed.

Request and Response

- ➔ request-line: GET http://<ip>/api/V1/MANAGEMENT/NETWORK/AUTH/USER1/Name
- ➔ status-line: 200 OK
- ➔ body: admin

Example

- ➔ request-line: GET http://192.168.0.50/api/V1/MANAGEMENT/NETWORK/AUTH/USER1/Name
- ⬅ status-line: 200 OK
- ⬅ body: admin

7.15.5. Setting a Password for Authentication

DIFFERENCE: From firmware version v 2.2.0, The minimum character requirement for the password is 10 characters, and it can contain any UTF-8 character.

INFO: Due to security reasons, the password is not stored in any property, so it can not be queried. No password is set by default, setting a password before authorizing the authentication is necessary.

Request and Response *#password*

- ➔ request-line: POST http://<ip>/api/V1/MANAGEMENT/NETWORK/AUTH/USER1/setPassword
- ➔ body: <password>
- ➔ status-line: 200 OK
- ➔ body: <password>

Parameters

Identifier	Parameter description	Value description
<password>	User defined password for authentication.	min. character length: 10 max. character length: 100 accepted characters: UTF-8 characters

Example

- ➔ request-line: POST http://192.168.0.50/api/V1/MANAGEMENT/NETWORK/AUTH/USER1/setPassword
- ➔ body: #password12
- ← status-line: 200 OK
- ← body: #password12

7.15.6. Enabling the Authentication

INFO: Set the password before enabling the authentication, because no password is set by default. Restarting the HTTP(S) services is required to apply the authentication settings.

Request and Response

- ➔ request-line: POST http://<ip>/api/V1/MANAGEMENT/NETWORK/SERVICES/<port>/AuthenticationEnabled
- ➔ body: <status>
- ➔ status-line: 200 OK
- ➔ body: <status>

Parameters

Identifier	Parameter description	Parameter values
<port>	Port type	HTTP / HTTPS
<status>	Authentication enabled	true
	Authentication disabled	false

Example

- ➔ request-line: POST http://192.168.0.50/api/V1/MANAGEMENT/NETWORK/SERVICES/HTTP/AuthenticationEnabled
- ➔ body: false
- ← status-line: 200 OK
- ← body: false

7.16. Advanced Ethernet Security

7.16.1. Setting the VLAN Preset

DIFFERENCE: This command is available from firmware package v1.6.0.

Request and Response

→ request-line: POST http://<ip>/api/V1/MEDIA/ETHERNET.VlanPreset
 → body: <vlan_preset>
 → status-line: 200 OK
 → body: <vlan_preset>

Parameters

Parameter	Parameter description	Values	Value description
<vlan_preset>	VLAN preset mode	Transparent	The same open network is used by the Taurus and the BYOD devices.
		SeparatedByod	The BYOD devices use a network that is separated from the main line.
		Dedicated	Every BYOD device uses a separate network.

Example

→ request-line: POST http://192.168.0.125/api/V1/MEDIA/ETHERNET.VlanPreset
 → body: SeparatedByod
 ← status-line: 200 OK
 ← body: SeparatedByod

7.16.2. Setting the VLAN Membership

DIFFERENCE: This command is available from firmware package v2.9.0.

ATTENTION! Changing the VLAN membership of the Control Ethernet port will cause loss of the connection to the device. Please make sure you are changing the correct settings.

With this command the Ethernet ports can be arranged into separate networks in any setup desired.

Request and Response

→ request-line: POST http://<ip>/api/V1/MEDIA/ETHERNET/<port_number>.VlanMembership
 → body: <vlan_membership>
 → status-line: 200 OK
 → body: <vlan_mebership>

Parameters

Parameter	Parameter description	Values	Value description
<vlan_membership>	VLAN mebership number	1-8	The ports with the same membership number are part of the same network.

Example

→ request-line: POST http://192.168.0.144/api/V1/MEDI/ETHERNET/P3.VlanMembership
 → body: 3
 ← status-line: OK
 ← body: 3

7.17. Serial Port Configuration

INFO: Port numbering can be found in the [Port Numbering](#) section.

7.17.1. BAUD Rate Setting

Request and Response #rs-232 #rs232

- request-line: POST http://<ip>/api/V1/MEDIA/SERIAL/<serial_port>/Baudrate
- body: <baudrate>
- status-line: 200 OK
- body: <baudrate>

Parameters

Identifier	Parameter description	Parameter values
<serial_port>	Serial port number	P1-P2
<baudrate>	Baud rate value	9600 19200 38400 57600 115200

Example

- request-line: POST http://192.168.0.50/api/V1/MEDIA/SERIAL/P1/Baudrate
- body: 19200
- ← status-line: 200 OK
- ← body: 19200

7.17.2. Stop Bits Setting

Request and Response #rs232 #rs-232 #serial

- request-line: POST http://<ip>/api/V1/MEDIA/SERIAL/<serial_port>/StopBits
- body: <stopbits>
- status-line: 200 OK
- body: <stopbits>

Parameters

Identifier	Parameter description	Parameter values
<serial_port>	Serial port number	P1-P2
<stopbits>	Stop bit value	1 2

Example

- request-line: POST http://192.168.0.50/api/V1/MEDIA/SERIAL/P1/StopBits
- body: 1
- ← status-line: 200 OK
- ← body: 1

7.17.3. Querying the Data Bits

Request and Response

- request-line: GET http://<ip>/api/V1/MEDIA/SERIAL/<serial_port>/DataBits
- status-line: 200 OK
- body: <databits>

Parameters

Identifier	Parameter description	Parameter values
<serial_port>	Serial port number	P1-P2
<databits>	DataBits value	8 9

Example

- request-line: GET http://192.168.0.50/api/V1/MEDIA/SERIAL/P1/DataBits
- ← status-line: 200 OK
- ← body: 8

7.17.4. Parity Setting

Request and Response

- request-line: POST http://<ip>/api/V1/MEDIA/SERIAL/<serial_port>/Parity
- body: <parity>
- status-line: 200 OK
- body: <parity>

Parameters

Identifier	Parameter description	Parameter values
<serial_port>	Serial port number	P1-P2
<parity>	Parity value	None Odd Even

Example

```

→ request-line: POST http://192.168.0.50/api/V1/MEDIA/SERIAL/P1/Parity
→ body:      None
← status-line: 200 OK
← body:      None

```

7.17.5. Querying the Serial over IP Port Number**Request and Response**

```

→ request-line: GET http://<ip>/api/V1/MEDIA/SERIAL/<serial_port>/SERIALOVERIP/Port
→ status-line: 200 OK
→ body:      <port_nr>

```

Parameters

Identifier	Parameter description	Parameter values
<serial_port>	Serial port number	P1-P2
<port_nr>	Serial over IP port number	8001 8002

Example

```

→ request-line: GET http://192.168.0.50/api/V1/MEDIA/SERIAL/P1/SERIALOVERIP/Port
← status-line: 200 OK
← body:      8001

```

7.17.6. Enabling the Serial over IP Port**Request and Response** *#rs232 #rs-232 #serial*

```

→ request-line: POST http://<ip>/api/V1/MEDIA/SERIAL/<serial_port>/SERIALOVERIP/Enabled
→ body:      <state>
→ status-line: 200 OK
→ body:      <state>

```

Parameters

Identifier	Parameter description	Parameter values
<serial_port>	Serial port number	P1-P2
<state>		true false

Example

```

→ request-line: POST http://192.168.0.50/api/V1/MEDIA/SERIAL/P1/SERIALOVERIP/Enabled
→ body:      false
← status-line: 200 OK
← body:      false

```

7.18. Serial Port Messaging**7.18.1. Sending a Message via RS-232**

ATTENTION! Serial message sending is implemented only via Lightware REST API. This function is not available with LW3 protocol command. *#message*

Request and Response

```

→ request-line: POST http://<ip>/api/V1/MEDIA/SERIAL/<serial_port>/send
→ body:      <message>
→ status-line: 200 OK

```

Parameters

Identifier	Parameter description	Parameter values
<serial_port>	Serial port number	P1-P2
<message>	Serial message	Any format is acceptable (text, binary, hexadecimal etc.), maximum message size is 100K. Escaping is unnecessary.

Example

```

→ request-line: POST http://192.168.0.50/api/V1/MEDIA/SERIAL/P1/send
→ body:      PWR0
← status-line: 200 OK

```

The 'PWR0' message is sent out via the P1 serial port.

INFO: Taurus can receive a serial message in a special way. When a message is sent from the Taurus, the response from the connected device is accepted within 100 ms. The communication is closed after that time interval.

7.19. GPIO Port Configuration

7.19.1. Setting the Direction of a GPIO Pin

Request and Response

- request-line: POST http://<ip>/api/V1/MEDIA/GPIO/<port>/Direction
- body: <dir>
- status-line: 200 OK
- body: <dir>

Parameters

Parameter	Parameter description	Value	Value description
<dir>	The direction of the GPIO pin.	Input	input
		Output	output

Example

- request-line: POST http://192.168.0.50/api/V1/MEDIA/GPIO/P1/Direction
- body: Input
- ← status-line: 200 OK
- ← body: Input

7.19.2. Setting the Output Level of a GPIO Pin

Request and Response

- request-line: POST http://<ip>/api/V1/MEDIA/GPIO/<port>/Output
- body: <state>
- status-line: 200 OK
- body: <state>

Parameters

Parameter	Parameter description	Value	Value description
<value>	The output value of the GPIO pin.	High	high level
		Low	low level

Example

- request-line: POST http://192.168.0.50/api/V1/MEDIA/GPIO/P1/Output
- body: High
- ← status-line: 200 OK
- ← body: High

7.19.3. Setting the Output Level for a Specified Time

Request and Response

- request-line: POST http://<ip>/api/V1/MEDIA/GPIO/<port>/interval
- body: <value>;<time>
- status-line: 200 OK
- body: <value>;<time>

Parameters

Parameter	Parameter description	Value	Value description
<value>	The output value of the GPIO pin.	High	high level
		Low	low level
<time>	Duration of the desired value in seconds.	1-120	second(s)

Example

- request-line: POST http://192.168.0.50/api/V1/MEDIA/GPIO/P1/interval
- body: Low;1
- ← status-line: 200 OK
- ← body: OK

7.19.4. Toggling the Level of a GPIO Pin

The output level can be changed from high to low and from low to high with the command below.

Request and Response

- request-line: POST http://<ip>/api/V1/MEDIA/GPIO/<port>/toggle
- INFO: The body has to be empty, and the content type should be text/plain.
- status-line: 200 OK
- body: OK

Example

- request-line: POST http://192.168.0.50/api/V1/MEDIA/GPIO/P1/toggle
- ← status-line: 200 OK
- ← body: OK

7.20. OCS Port Configuration

7.20.1. Querying the Input Level of an OCS Pin

Request and Response #ocs

→ request-line: GET·http://<ip>/api/V1/MEDIA/OCS/P1/InputLevel
 → status-line: 200·OK
 → body: <value>

Parameters

Parameter	Parameter description	Value	Value description
<value>	The input value of the OCS pin.	High	high level
		Low	low level

Example

→ request-line: GET http://192.168.0.50/api/V1/MEDIA/OCS/P1/InputLevel
 ← status-line: 200 OK
 ← body: Low

7.20.2. Setting the Sensor Type

Request and Response

→ request-line: POST·http://<ip>/api/V1/MEDIA/OCS/P1/SensorType·
 → body: <sensor_type>
 → status-line: 200 OK
 → body: <sensor_type>

Parameters

Parameter	Parameter description	Value	Value description
<sensor_type>	It defines whether the low or high input level means the occupancy.	Active low	Occupancy status is 'Occupied' when the input level is low.
		Active high	Occupancy status is 'Occupied' when the input level is high (default value).

Example

→ request-line: POST http://192.168.0.50/api/V1/MEDIA/OCS/P1/SensorType
 → body: Active low
 ← status-line: 200 OK
 ← body: Active low

7.20.3. Querying the Reported OCS State

Request and Response

→ request-line: GET·http://<ip>/api/V1/MEDIA/OCS/P1/State
 → status-line: 200·OK
 → body: <status>

Parameters

Parameter	Parameter description	Value	Value description
<status>	It reports the occupancy state of the room depending on the sensor type.	Free	When the SensorType=Active high and the Inputlevel=Low or when SensorType=Active low and Inputlevel=High
		Occupied	When the SensorType=Active high and the Inputlevel=High or when SensorType=Active low and Inputlevel=Low

Example

→ request-line: GET http://192.168.0.50/api/V1/MEDIA/OCS/P1/State
 ← status-line: 200 OK
 ← body: Free

7.21. Updating the Device via REST API

7.21.1. Querying the Update REST API Version

Request and Response

- ➔ request: GET http://<ip>/api/V1/MANAGEMENT/UPDATE/Version
- ➔ response: <standard_response>
- ➔ body: <major>.<minor>

Parameters

Parameter	Parameter description	Values	Value description
<ip>	The IP address of the device separated with dots.		e.g.: 192.168.0.110
<standard_response>	Standard HTTP response	200 OK	The request has succeeded.
		400 Bad request	The request cannot be processed.
<major>	REST API major version number		
<minor>	REST API minor version number		

Example

- ➔ request: GET http://192.168.0.110/api/V1/MANAGEMENT/UPDATE/Version
- ⬅ response: 200 OK
- ⬅ body: 1.1

7.21.2. The Updating Process

The API allows the device to update itself with an LFP2 FW package. This new approach means there is no need to run a software on the connected PC (in case of LDU2) for updating the Lightware device.

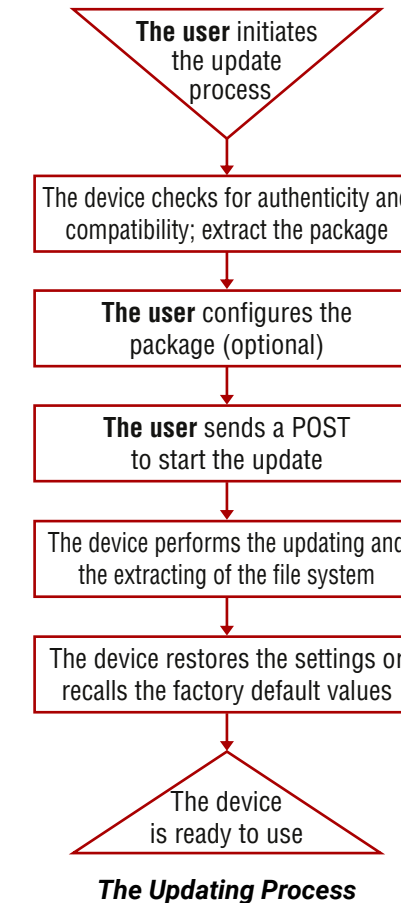

The Updating Steps

1. The **User uploads the package** to a dedicated URL.
 - The package is being unpacked during the uploading process.
 - The package is checked by the device to see if they are compatible with each other.
2. The **User can set the uploaded package**.
 - The factory default settings can be recalled (this is the default setting of the package) or the current settings of the device can be restored (optional).
3. The **User starts the self-updating process** by sending a POST method.
 - The device performs the operations in connection with the update (e.g. file system replacement).
 - The device restores the previous settings to the new system, if it was set to.
4. The device is ready to use.

7.21.3. Uploading the Package

This step may take up to one or two minutes to finish as the size of the LFP2 package is approx. 100-150 MB (depends on the device and FW version).

Request and Response

- ➔ request: POST-`http://<ip/host>/api/V1/MANAGEMENT/UPDATE/Package`
- ➔ body: `<LFP2 file>`
- ➔ content-type: `application/octet-stream`
- ➔ response: `<standard_response>`
- ➔ body: `<message>`

Parameters

Parameter	Parameter description	Values	Value description
<code><ip/host></code>	The IP address or the host name of the device.		e.g.: 192.168.0.110, myDevice
<code><standard_response></code>	Standard HTTP response	200 OK 400 Bad request 500 Internal Server Error	<code><message></code> : OK The request has succeeded; the whole package is extracted and the basic checks are done. <code><message></code> : Package incompatible: Incompatible partnumber: [...] The request cannot be processed; error during the uploading/checking. e.g. the package is not compatible with the device. The <code><message></code> is in text/plain format. <code><message></code> : Socket timeout The package uploading was not successful. Please try it again.

Example

- ➔ request: POST `http://192.168.0.114/api/V1/MANAGEMENT/UPDATE/Package`
- ➔ body: (the LFP2 file)
- ← response: **200 OK**
- ← body: **OK**

7.21.4. Configuration Parameters – Keep the Current Settings

DIFFERENCE: This feature is available from **FW package v2.1.0**.

ATTENTION! Restoring the device settings is not allowed if the firmware is **downgraded** to a previous version or the existing (=running) FW package of the device is **v1.x**. In those cases, recalling the factory default settings is a must.

This is an **optional step** that allows keeping the current settings of the device. The **default setting** of an update is to **recall the factory default** values. If you want to keep the current settings of the device, delete the **'dofactoryreset'** file from the uploaded package as follows:

Request and Response

- ➔ request: DELETE-`http://<ip/host>/api/V1/MANAGEMENT/UPDATE/CONFIG/dofactoryreset`
- ➔ response: `<standard_response>`
- ➔ body: `<message>`

Parameters

Parameter	Parameter description	Values	Value description
<code><ip/host></code>	The IP address or the host name of the device.		e.g.: 192.168.0.110, myDevice
<code><standard_response></code>	Standard HTTP response	200 OK 405 Method not allowed 500 Internal Server Error	"Deleted" LFP2 package was not uploaded to the device. The file does not exist in the uploaded package (e.g. it was deleted previously). Continue the update process.

Example

- ➔ request: DELETE `http://192.168.0.114/api/V1/MANAGEMENT/UPDATE/CONFIG/dofactoryreset`
- ← response: **200 OK**
- ← body: **Deleted**

7.21.5. Executing the Update

The command is for installing the uploaded package in place of the current system. This step may take up to 7 minutes.

Request and Response

- ➔ request: POST http://<ip/host>/api/V1/MANAGEMENT/UPDATE/update
- ➔ body: <payload>
- ➔ content-type: text/plain
- ➔ response: <standard_response>
- ➔ body: <message>

Parameters

Parameter	Parameter description	Values	Value description
<ip/host>	The IP address or the host name of the device.		e.g.: 192.168.0.110, myDevice
<payload>	optional	force	The update can be forced to run in Package incompatible error state, but the security check cannot be bypassed (Package untrusted state).
<standard_response>	Standard HTTP response	200 OK	The request has succeeded; the update process finished successfully.
		400 Bad request	The request cannot be processed. it may happen that the uploaded package is not compatible with the device (Package incompatible error state) and the force payload was not used.

ATTENTION! Please note that running a **forced update** can make the device inoperable.

Example

- ➔ request: POST http://192.168.0.114/api/V1/MANAGEMENT/UPDATE/update
- ← response: 200 OK
- ← body: OK

When the 'force' payload is used:

- ➔ request: POST http://192.168.0.114/api/V1/MANAGEMENT/UPDATE/update
- ➔ body: force
- ➔ content-type: RAW (JSON)
- ← response: 200 OK
- ← body: OK

7.21.6. Querying the State of the Updating Process

This command is for querying the current state of the updating process.

Request and Response

- ➔ request: GET http://<ip/host>/api/V1/MANAGEMENT/UPDATE/Status
- ➔ response: <standard_response>
- ➔ body: <message>

Parameters

Parameter	Parameter description	Values	Value description
<ip/host>	The IP address or the host name of the device.		e.g.: 192.168.0.110, myDevice
<standard_response>	Standard HTTP response	200 OK	The request has succeeded. <message> states: Idle: not active, update has not started yet. Package uploading: updating and checking is in progress. Package ready: uploading is done, checking is successful.
		400 Bad Request	The request cannot be processed. <message> states: Package incompatible: the uploaded package is not compatible with the device. Package untrusted: the uploaded package is not secure. Failed: the update is not successful.

INFO: Please note that while the new firmware is being programmed in the device, it cannot send a response for a request. Thus the current state cannot be requested either.

After the firmware update is finished successfully, the device would send the 'Idle' response when requesting its status with this command.

Example

- ➔ request: GET http://192.168.0.114/api/V1/MANAGEMENT/UPDATE/Status
- ← response: 200 OK
- ← body: Package uploading

7.22. Lightware REST API Quick Summary

System Commands

Setting the Device Label

- request-line: POST·http://<ip>/api/V1/MANAGEMENT/LABEL/DeviceLabel
- body: <custom_name>

Resetting the Device

- request-line: POST·http://<ip>/api/V1/SYS/restart

Restoring the Factory Default Settings

- request-line: POST·http://<ip>/api/V1/SYS/factoryDefaults

Querying the Firmware Package Version

- request-line: GET·http://<ip>/api/V1/MANAGEMENT/UID/PACKAGE/Version

Control Lock

- request-line: POST·http://<ip>/api/V1/MANAGEMENT/UI/ControlLock
- body: <lock_status>

Setting the Current Time

- request-line: POST·http://<ip>/api/V1/MANAGEMENT/DATETIME/setTime
- body: <current_time>

Identifying the Device

- request-line: POST·http://<ip>/api/V1/MANAGEMENT/UI/identifyMe

Toggling the Dark Mode Setting

- request-line: POST·http://<ip>/api/V1/MANAGEMENT/UI/DARKMODE/Enable
- body: <mode_state>

Setting the Delay of the Dark Mode

- request-line: POST·http://<ip>/api/V1/MANAGEMENT/UI/DARKMODE/Delay
- body: <delay_time>

Video Port Settings - General

Switching the Video Input

- request-line: POST·http://<ip>/api/V1/MEDIA/VIDEO/XP/switch
- body: <in>:<out>

Switching an Input to All Outputs

- request-line: POST·http://<ip>/api/V1/MEDIA/VIDEO/XP/switchAll
- body: <in>

Locking the Video Port

- request-line: POST·http://<ip>/api/V1/MEDIA/VIDEO/XP/<port>/Lock
- body: <locked_state>

Muting the Video Port

- request-line: POST·http://<ip>/api/V1/MEDIA/VIDEO/XP/<port>/Mute
- body: <muted_state>

Setting the Autoselect Policy

- request-line: POST·http://<ip>/api/V1/MEDIA/VIDEO/AUTOSELECT/<out>/Policy
- body: <autoselect_mode>

Changing the Autoselect-Included Input Ports

- request-line: POST·http://<ip>/api/V1/MEDIA/VIDEO/AUTOSELECT/<out>/<in>/Included
- body: <state>

Changing the Input Port Priority

- request-line: POST·http://<ip>/api/V1/MEDIA/VIDEO/AUTOSELECT/<out>/<in>/Priority
- body: <prio_num>

Querying the Connected Source

- request-line: GET·http://<ip>/api/V1/MEDIA/VIDEO/XP/<out>/ConnectedSource

Querying the Connected Destinations

- request-line: GET·http://<ip>/api/V1/MEDIA/VIDEO/XP/<in>/ConnectedDestinations

Querying the Input Switching Capability

- request-line: GET·http://<ip>/api/V1/MEDIA/VIDEO/XP/<out>/SWITCHABLE/<in>

Query the Video Signal Presence

- request-line: GET·http://<ip>/api/V1/MEDIA/VIDEO/<port>/SignalPresent

HDCP Setting (Input Port)

- request-line: POST·http://<ip>/api/V1/MEDIA/VIDEO/<in>/HDCP/AllowedHdcpVersion
- body: <allowed_hdcp>

HdcpMode

- request-line: POST·http://<ip>/api/V1/MEDIA/VIDEO/<out>/HdcpMode
- body: <hdcp_mode>

Querying the Embedded Audio Presence

- request-line: GET·http://<ip>/api/V1/MEDIA/VIDEO/<port>/EmbeddedAudioPresent

Muting the Embedded Audio

- request-line: POST·http://<ip>/api/V1/MEDIA/VIDEO/<port>/EmbeddedAudioMute
- body: <mute_state>

Setting the Output Signal Type

- request-line: POST·http://<ip>/api/V1/MEDIA/VIDEO/<out>/OutputSignalType
- body: <signal_type>

Turning on Output 5V

- request-line: POST·http://<ip>/api/V1/MEDIA/VIDEO/<out>/Output5VMode
- body: <5V_pwr>

Welcome Screen Settings

Displaying the Welcome Screen Image

- request-line: POST·http://<ip>/api/V1/MEDIA/VIDEO/I5/WELCOMESCREEN/ImageEnabled
- body: <image_state>

Displaying the Welcome Screen Text

- request-line: POST·http://<ip>/api/V1/MEDIA/VIDEO/I5/WELCOMESCREEN/MessageEnabled
- body: <text_state>

Setting the Welcome Screen Text

- request-line: POST·http://<ip>/api/V1/MEDIA/VIDEO/I5/WELCOMESCREEN/MessageText
- body: <text>

Resetting the Welcome Screen Image

- request-line: POST·http://<ip>/api/V1/MEDIA/VIDEO/I5/WELCOMESCREEN/resetImage

Video Port Settings - USB-C Related Commands

Restarting the Link Training

- request-line: POST·http://<ip>/api/V1/MEDIA/VIDEO/<in>/DP/restartLinkTraining

CEC Command Sending

Simple CEC Code Sending

- request-line: POST·http://<ip>/api/V1/MEDIA/VIDEO/<port>/CEC/send
- body: <command>

Remote Control Code Sending

- request-line: POST·http://<ip>/api/V1/MEDIA/VIDEO/<port>/CEC/sendUserControlClick
- body: <command>

Audio Port Settings

Switching the Audio Input

- request-line: POST·http://<ip>/api/V1/MEDIA/AUDIO/XP/switch
- body: <audio_in>:O3

Querying the Connected Source

- request-line: GET·http://<ip>/api/V1/MEDIA/AUDIO/XP/O3/ConnectedSource

Querying the Connected Destinations

- request-line: GET·http://<ip>/api/V1/MEDIA/AUDIO/XP/<audio_in>/ConnectedDestinations

Setting the Autoselect Operation Mode

- request-line: POST·http://<ip>/api/V1/MEDIA/AUDIO/AUTOSELECT/O3/Policy
- body: <op_mode>

Setting the Followed Video Port to Autoselect

- request-line: POST·http://<ip>/api/V1/MEDIA/AUDIO/AUTOSELECT/O3/VideoFollowPort
- body: <out>

Enabling/Disabling the Dante USB Sound Card

- request-line: POST /V1/SYS/BD_DANTE_ADDON/Enabled
- body: <status>

Setting the Audio Device Type for the Dante Input

- request-line: POST /V1/MEDIA/AUDIO/DANTE_IN/AudioDeviceType
- body: <device_type>

Locking the Audio Port

- request-line: POST·http://<ip>/api/V1/MEDIA/AUDIO/XP/<audio_port>/Lock
- body: <locked_state>

Muting the Audio Port 1.

- request-line: POST·http://<ip>/api/V1/MEDIA/AUDIO/XP/<audio_port>/Mute
- body: <muted_state>

Muting the Audio Port 2.

- request-line: POST·http://<ip>/api/V1/MEDIA/AUDIO/O3/Mute
- body: <muted_state>

Querying the Audio Signal Presence

- request-line: GET·http://<ip>/api/V1/MEDIA/AUDIO/<audio_port>/SignalPresent

Analog Audio Output Volume (dB) Setting

- request-line: POST·http://<ip>/api/V1/MEDIA/AUDIO/O3/VolumedB
- body: <level>

Analog Audio Output Volume Percent Setting

- request-line: POST·http://<ip>/api/V1/MEDIA/AUDIO/O3/VolumePercent
- body: <percent>

Setting the Balance

- request-line: POST·http://<ip>/api/V1/MEDIA/AUDIO/O3/Balance
- body: <level>

Analog Audio Output Level Setting by Steps (dB)

- request-line: POST·http://<ip>/api/V1/MEDIA/AUDIO/O3/stepVolumedB
- body: <step>

Analog Audio Output Level Setting by Steps in Percent

- request-line: POST·http://<ip>/api/V1/MEDIA/AUDIO/O3/stepVolumePercent
- body: <step>

Analog Audio Output Balance Setting by Steps

- request-line: POST·http://<ip>/api/V1/MEDIA/AUDIO/O3/stepBalance
- body: <step>

USB Port Settings**Switching the USB Input**

- request-line: POST·http://<ip>/api/V1/MEDIA/USB/XP/switch<host>/H1
- body: <host>:H1

Querying the Connected Source

- request-line: GET·http://<ip>/api/V1/MEDIA/USB/XP/H1/ConnectedSource

Querying the Connected Destinations

- request-line: GET·http://<ip>/api/V1/MEDIA/USB/XP/<host>/ConnectedDestinations

Locking the USB Port

- request-line: POST·http://<ip>/api/V1/MEDIA/USB/XP/<usb_port>/Lock
- body: <locked_state>

Setting the 5V Sending to the USB Peripherals

- request-line: POST·http://<ip>/api/V1/MEDIA/USB/H1/<device_id>/Power5VMode
- body: <device_pwr>

Setting the USB Autoselect Policy

- request-line: POST·http://<ip>/api/V1/MEDIA/USB/AUTOSELECT/H1/Policy
- body: <op_mode>

Setting the Followed Video Port to Autoselect

- request-line: POST·http://<ip>/api/V1/MEDIA/USB/AUTOSELECT/H1/VideoFollowPort
- body: <out>

Changing the Autoselect Included USB Ports

- request-line: POST·http://<ip>/api/V1/MEDIA/USB/AUTOSELECT/H1/<host>/Included
- body: <state>

Changing the USB Port Priority

- request-line: POST·http://<ip>/api/V1/MEDIA/USB/AUTOSELECT/H1/<host>/Priority
- body: <prio_num>

USB Port Settings - USB-C Related Commands**Setting the USB-C Power**

- request-line: POST·http://<ip>/api/V1/SYS/MB/USBCPOWER/PowerLimit
- body: <power>

Setting the Displayport Alternate Mode Policy

- request-line: POST·http://<ip>/api/V1/MEDIA/USB/<usb-c_port>/DpAltModePolicy
- body: <dp_policy>

Querying the Host Alternate Mode Support

- request-line: GET·http://<ip>/api/V1/MEDIA/USB/<usb-c_port>/HostSupportsDpAltMode

Querying the Status of the Alternate Mode

- request-line: GET·http://<ip>/api/V1/MEDIA/USB/<usb-c_port>/ActiveAltMode

Querying the Port Data Role

- request-line: GET·http://<ip>/api/V1/MEDIA/USB/<usb-c_port>/ActivePortDataRole

Querying the Port Power Role

- request-line: GET·http://<ip>/api/V1/MEDIA/USB/<usb-c_port>/ActivePortPowerRole

Setting the Port Power Role

- request-line: POST·http://<ip>/api/V1/MEDIA/USB/<usb-c_port>/PortPowerRoleSetting
- body: <power_role>

EDID Management**Querying the Emulated EDIDs**

- request-line: GET·http://<ip>/api/V1/EDID/EdidStatus

Querying the Validity of a Dynamic EDID

- request-line: GET·http://<ip>/api/V1/EDID/D/D1/Validity

Querying the Preferred Resolution of a User EDID

- request-line: GET·http://<ip>/api/V1/EDID/U/<user_edid>/PreferredResolution

Emulating an EDID to an Input Port

- request-line: POST·http://<ip>/api/V1/EDID/switch
- body: <source>:<destination>

Emulating an EDID to All Input Ports

- request-line: POST·http://<ip>/api/V1/EDID/switchAll
- body: <source>

Copying an EDID to User Memory

- request-line: POST·http://<ip>/api/V1/EDID/copy
- body: <source>:<destination>

Deleting an EDID from User Memory

- ➔ request-line: POST·http://<ip>/api/V1/EDID/delete
- ➔ body: <user_edid>

Resetting the Emulated EDIDs

- ➔ request-line: POST·http://<ip>/api/V1/EDID/reset

Ethernet Port Configuration**Setting the DHCP State**

- ➔ request-line: POST·http://<ip>/api/V1/MANAGEMENT/NETWORK/DhcpEnabled
- ➔ body: <dhcp_status>

Changing the IP Address (Static)

- ➔ request-line: POST·http://<ip>/api/V1/MANAGEMENT/NETWORK/StaticIpAddress
- ➔ body: <IP_address>

Changing the Subnet Mask (Static)

- ➔ request-line: POST·http://<ip>/api/V1/MANAGEMENT/NETWORK/StaticNetworkMask
- ➔ body: <netmask>

Changing the Gateway Address (Static)

- ➔ request-line: POST·http://<ip>/api/V1/MANAGEMENT/NETWORK/StaticGatewayAddress
- ➔ body: <gw_address>

Applying the Network Settings

- ➔ request-line: POST·http://<ip>/api/V1/MANAGEMENT/NETWORK/applySettings

Setting the Hostname

- ➔ request-line: POST·http://<ip>/api/V1/MANAGEMENT/NETWORK/HostName
- ➔ body: <unique_name>

Network Security**Enabling/Disabling the Ethernet Port**

- ➔ request-line: POST·http://<ip>/api/V1/MEDIA/ETHERNET/<ethernet_port>/Enabled
- ➔ body: <status>

Querying the Network Service Port Number

- ➔ request-line: GET·http://<ip>/api/V1/MANAGEMENT/NETWORK/SERVICES/<port>/Port

Enabling/Disabling the Network Service Port

- ➔ request-line: GET·http://<ip>/api/V1/MANAGEMENT/NETWORK/SERVICES/<port>/Enabled
- ➔ body: <status>

Querying the Username for Authentication

- ➔ request-line: GET·http://<ip>/api/V1/MANAGEMENT/NETWORK/AUTH/USER1/Name

Setting a Password for Authentication

- ➔ request-line: POST·http://<ip>/api/V1/MANAGEMENT/NETWORK/AUTH/USER1/setPassword
- ➔ body: <password>

Enabling the Authentication

- ➔ request-line: POST·http://<ip>/api/V1/MANAGEMENT/NETWORK/SERVICES/<port>/AuthenticationEnabled
- ➔ body: <status>

Advanced Ethernet Security**Setting the VLAN Preset**

- ➔ request-line: POST·http://<ip>/api/V1/MEDIA/ETHERNET.VlanPreset
- ➔ body: <vlan_preset>

Setting the VLAN Membership

- ➔ request-line: POST·http://<ip>/api/V1/MEDIA/ETHERNET/<port_number>.VlanMembership
- ➔ body: <vlan_membership>

Serial Port Configuration**BAUD Rate Setting**

- ➔ request-line: POST·http://<ip>/api/V1/MEDIA/SERIAL/<serial_port>/Baudrate
- ➔ body: <baudrate>

Stop Bits Setting

- ➔ request-line: POST·http://<ip>/api/V1/MEDIA/SERIAL/<serial_port>/StopBits
- ➔ body: <stopbits>

Querying the Data Bits

- ➔ request-line: GET·http://<ip>/api/V1/MEDIA/SERIAL/<serial_port>/DataBits

Parity Setting

- ➔ request-line: POST·http://<ip>/api/V1/MEDIA/SERIAL/<serial_port>/Parity
- ➔ body: <parity>

Querying the Serial over IP Port Number

- ➔ request-line: GET·http://<ip>/api/V1/MEDIA/SERIAL/<serial_port>/SERIALOVERIP/Port

Enabling the Serial over IP Port

- ➔ request-line: POST·http://<ip>/api/V1/MEDIA/SERIAL/<serial_port>/SERIALOVERIP/Enabled
- ➔ body: <state>

Serial Port Messaging**Sending a Message via RS-232**

- ➔ request-line: POST·http://<ip>/api/V1/MEDIA/SERIAL/<serial_port>/send
- ➔ body: <message>

GPIO Port Configuration**Setting the Direction of a GPIO Pin**

→ request-line: POST·http://<ip>/api/V1/MEDIA/GPIO/<port>/Direction
 → body: <dir>

Setting the Output Level of a GPIO Pin

→ request-line: POST·http://<ip>/api/V1/MEDIA/GPIO/<port>/Output
 → body: <state>

Setting the Output Level for a Specified Time

→ request-line: POST·http://<ip>/api/V1/MEDIA/GPIO/<port>/interval
 → body: <value>;<time>

Toggling the Level of a GPIO Pin

→ request-line: POST·http://<ip>/api/V1/MEDIA/GPIO/<port>/toggle

OCS Port Configuration**Querying the Input Level of an OCS Pin**

→ request-line: GET·http://<ip>/api/V1/MEDIA/OCS/P1/InputLevel

Setting the Sensor Type

→ request-line: POST·http://<ip>/api/V1/MEDIA/OCS/P1/SensorType·
 → body: <sensor_type>

Querying the Reported OCS State

→ request-line: GET·http://<ip>/api/V1/MEDIA/OCS/P1/State

Updating the Device via REST API**Querying the Update REST API Version**

→ request: GET·http://<ip>/api/V1/MANAGEMENT/UPDATE/Version

Uploading the Package

→ request: POST·http://<ip/host>/api/V1/MANAGEMENT/UPDATE/Package
 → body: <LFP2 file>
 → content-type: application/octet-stream

Configuration Parameters – Keep the Current Settings

→ request: DELETE·http://<ip/host>/api/V1/MANAGEMENT/UPDATE/CONFIG/dofactoryreset

Executing the Update

→ request: POST·http://<ip/host>/api/V1/MANAGEMENT/UPDATE/update
 → body: <payload>
 → content-type: text/plain

Querying the State of the Updating Process

→ request: GET·http://<ip/host>/api/V1/MANAGEMENT/UPDATE/Status

8

LW3 Programmers' Reference

The device can be controlled through Lightware 3 (LW3) protocol commands to ensure the compatibility with other Lightware products. The supported LW3 commands are described in this chapter.

- ▶ [OVERVIEW](#)
- ▶ [INSTRUCTIONS FOR THE TERMINAL APPLICATION USAGE](#)
- ▶ [WEBSOCKET \(WS\) OR SECURED WEBSOCKET \(WSS\) USAGE](#)
- ▶ [PROTOCOL RULES](#)
- ▶ [SYSTEM COMMANDS](#)
- ▶ [VIDEO PORT SETTINGS - GENERAL](#)
- ▶ [WELCOME SCREEN SETTINGS](#)
- ▶ [VIDEO PORT SETTINGS - USB-C RELATED COMMANDS](#)
- ▶ [CEC COMMAND SENDING](#)
- ▶ [AUDIO PORT SETTINGS](#)
- ▶ [USB PORT SETTINGS](#)
- ▶ [USB PORT SETTINGS - USB-C RELATED COMMANDS](#)
- ▶ [EDID MANAGEMENT](#)
- ▶ [ETHERNET PORT CONFIGURATION](#)
- ▶ [NETWORK SECURITY](#)
- ▶ [ADVANCED ETHERNET SECURITY](#)
- ▶ [SERIAL PORT CONFIGURATION](#)
- ▶ [SENDING A MESSAGE VIA RS-232](#)
- ▶ [GPIO PORT CONFIGURATION](#)
- ▶ [OCS PORT CONFIGURATION](#)
- ▶ [LW3 COMMANDS - QUICK SUMMARY](#)

8.1. Overview

The Lightware Protocol #3 (LW3) is implemented in almost all new Lightware devices (matrix switchers, signal extenders and distribution amplifiers) since 2012. The protocol is ASCII-based and all commands are terminated with a carriage return (Cr, '\r') and line feed (Lf, '\n') pair. It is organized as a tree structure that provides outstanding flexibility and user-friendly handling with 'nodes', 'properties' and 'methods'. The **Advanced View** of the Lightware Device Controller software is the perfect tool for browsing and learning how the LW3 protocol can be used in practice.

8.2. Instructions for the Terminal Application Usage

Terminal Application

The LW3 protocol commands can be applied to the switcher using a terminal application. You need to install one of them on your control device, for example **Putty** or **CLI**. `#terminal`

Establishing Connection

Follow the steps to establish connection to the switcher:

- Step 1.** Connect the device to a LAN over Ethernet.
- Step 2.** Open the terminal application (e.g. Putty).
- Step 3.** Add the **IP address** of the device (default: DHCP) and the **port number (6107)**.
- Step 4.** Select the **Raw** connection type, and open the connection.

Once the terminal window is opened, you can enter the LW3 protocol commands, which are listed in the following sections.

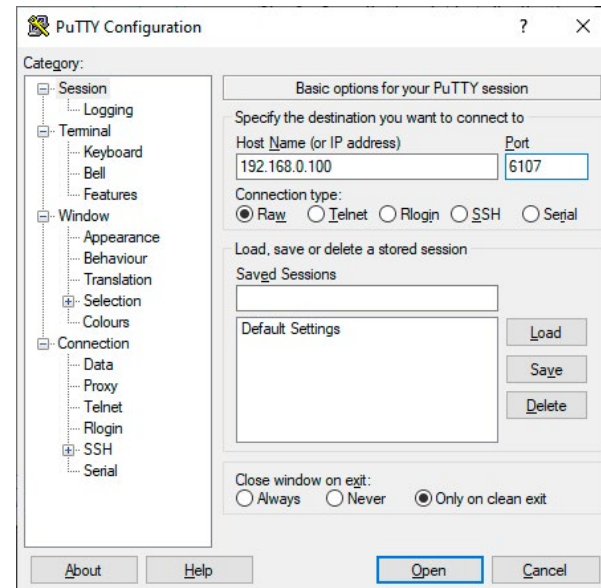

```

172.24.5.39 - PuTTY
GET /V1/MEDIA/+
n- /V1/MEDIA/AUDIO/I1
n- /V1/MEDIA/AUDIO/I2
n- /V1/MEDIA/AUDIO/I3
n- /V1/MEDIA/AUDIO/I4
n- /V1/MEDIA/AUDIO/O1
n- /V1/MEDIA/AUDIO/O2
n- /V1/MEDIA/AUDIO/O3
n- /V1/MEDIA/AUDIO/XP
n- /V1/MEDIA/AUDIO/AUTOSELECT
n- /V1/MEDIA/ETHERNET/P1
n- /V1/MEDIA/ETHERNET/P2
n- /V1/MEDIA/ETHERNET/P3
n- /V1/MEDIA/ETHERNET/P4
n- /V1/MEDIA/ETHERNET/P5
n- /V1/MEDIA/USB/U1
n- /V1/MEDIA/USB/U2

```

LW3 protocol command communication in a terminal window

8.3. Websocket (WS) or Secured Websocket (WSS) Usage

DIFFERENCE: Websocket (WS) or Secured Websocket (WSS) service is available only from FW package v1.2.0.

UCX series switcher provides WS/WSS services on its 80 (for WS) and 443 (for WSS) ports to control the device with LW3 protocol commands. For more details about the websocket, see the [WebSocket Service \(WS, WSS\)](#) section.

The LW3 node tree is available after opening a session with the device on the following path:

- `ws://<ip>/lw3`
- `wss://<ip>/lw3`

WebSocket Client Application

Establishing Connection

Follow the steps to establish connection to the switcher:

- Step 1.** Connect the receiver to a LAN over Ethernet.
- Step 2.** Open the websocket client (e.g. Simple websocket Client).
- Step 3.** Add the **IP address** of the device (default: DHCP): `ws://<ip>/lw3` or `wss://<ip>/lw3`
- Step 4.** Press the open/connect button.
- Step 5.** Once connected, enter a message and press the Send button.
- Step 6.** Press the Close/Disconnect button to end the session.

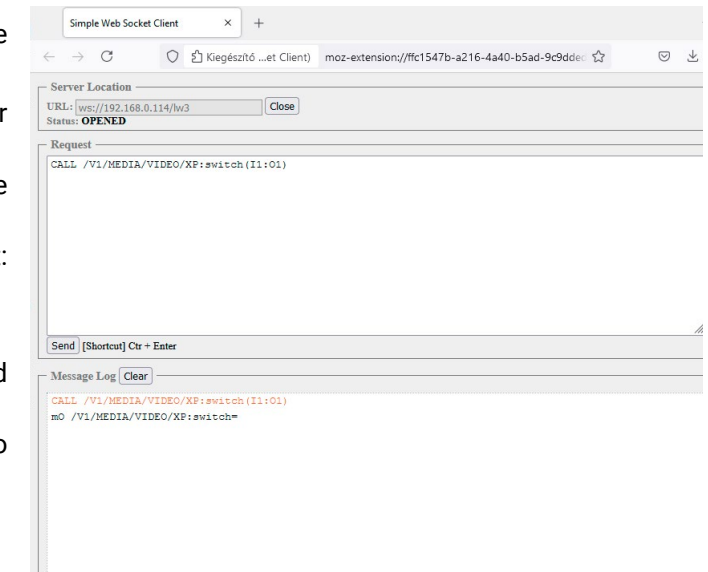

8.4. Protocol Rules

8.4.1. LW3 Tree Structure and Command Structure (examples)

8.4.2. General Rules

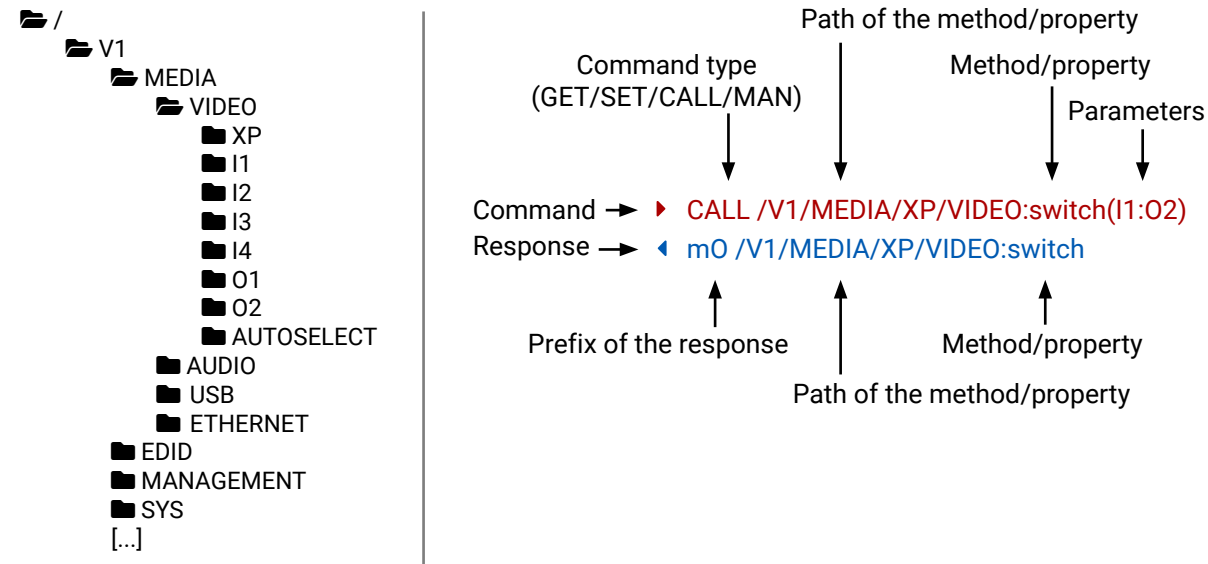

- Up to FW version v2.9.0, all names and parameters are **case-sensitive**.
- The nodes are separated by a slash ('/') character.
- The node name can contain the elements of the English alphabet and numbers.
- Use the **TCP port no. 6107** when using LW3 protocol over Ethernet.
- The 80 port can be used for WS (instead of HTTP)
- The 443 port can be used for WSS (instead of HTTPS)
- When a command is issued by the device, the received response cannot be processed by the CPU.
- The node paths describe the exact location of the node, listing each parent node up to the root.
- The length of a line (command/response, command type / prefix, path, method/property and parameters together) can be max. 800 bytes.
- The command lines have to be closed by Carriage Return and Line Feed (CrLf)
- It can manage 18 connected clients in total simultaneously for WS (80), WSS (443) and LW3 (6107) ports.

8.4.3. Legend for the Control Commands

Command and Response – Example

- ▶ GET-/V1/MEDIA/VIDEO/I2.SignalPresent
- ◀ pr-/V1/MEDIA/VIDEO/I2.SignalPresent=<signal_present>

Format	Description
<in>	Input port number
<out>	Output port number
<port>	Input or output port number
<loc>	Location number
<parameter>	Variable defined and described in the command
<expression>	Batched parameters: the underline means that more expressions or parameters can be placed by using a semicolon, e.g. <u>I2;I4;I5</u> or <u>F27:E1;F47:E2</u>
▶	Sent command
◀	Received response
.	Space character

Further not listed <parameters> are defined at each command.

8.4.4. Command Types

GET Command

The **GET** command can be used to get the child nodes, properties and methods of a specific node. It can also be used to get the value of a property. Use the dot character (.) when addressing a property:

- ▶ **GET /.SerialNumber**
- ◀ **pr /.SerialNumber=87654321**

GETALL Command

The **GETALL** command can be used to get all child nodes, properties and methods of a node with one command.

- ▶ **GETALL /V1/MEDIA/ETHERNET**
- ◀ **n- /V1/MEDIA/ETHERNET/P1**
- ◀ **n- /V1/MEDIA/ETHERNET/P2**
- ◀ **n- /V1/MEDIA/ETHERNET/P3**
- ◀ **n- /V1/MEDIA/ETHERNET/P4**
- ◀ **n- /V1/MEDIA/ETHERNET/P5**

SET Command

The **SET** command can be used to modify the value of a property. Use the dot character (.) when addressing the property:

- ▶ **SET /V1/MEDIA/VIDEO/I2/HDCP.AllowedHdcpVersion=Off**
- ◀ **pw /V1/MEDIA/VIDEO/I2/HDCP.AllowedHdcpVersion=Off**

CALL Command

A method can be invoked by the **CALL** command. Use the colon character (:) when addressing the method:

- ▶ **CALL /V1/EDID:switchAll(F49)**
- ◀ **mO /V1/EDID:switchAll**

MAN Command

The manual is a human readable text that describes the syntax and provides a hint on how to use the primitives. For every node, property and method in the tree there is a manual; type the MAN command to get the manual:

- ▶ **MAN /V1/MEDIA/VIDEO/O1.Output5VMode**
- ◀ **pm /V1/MEDIA/VIDEO/O1.Output5VMode ["On" | "Auto" | "Off"] Enables/disables power 5V output**

8.4.5. Prefix Summary

DEFINITION: The prefix is a 2-character-long code that describes the type of the response.

The following prefixes are defined in the LW3 protocol:

Prefix	Description
n-	a node
nE	an error for a node
nm	a manual for a node
pr	a read-only property
pw	read-write property
pE	an error for the property
pm	a manual for the property
m-	a method
mO	a response after a successful method execution
mF	a response after a failed method execution
mE	an error for a method
mm	a manual for a method

8.4.6. Error Messages

There are several error messages defined in the LW3 protocol, all of them have a unique error number.

- ▶ **CALL /MEDIA/VIDEO/XP:lock(1A)**
- ◀ **mE /MEDIA/VIDEO/XP:lock %E002:Not exist**

8.4.7. Escaping

DEFINITION: An escape sequence is a sequence of characters that does not represent itself when used inside a character or string literal, but is translated into another character or a sequence of characters.

Property values and method parameters can contain characters that are used as control characters in the protocol. They must be escaped. The escape character is the backslash ('\') and escaping means injecting a backslash before the character that should be escaped (like in C language).

Control characters are the following: \ { } # % () \r \n \t

8.4.8. Signature

DEFINITION: The signature is a four-digit-long hexadecimal value that can be optionally placed before every command to keep a command and the corresponding responses together as a group.

Each line is terminated with Carriage Return (Cr, '\r') and Line Feed (Lf, '\n') characters. In several cases the number of the lines in the response cannot be determined in advance, e.g. the client intends to receive the whole response and also wants to be sure that the received lines belong together and to the same command. In these cases, a special feature, the 'signature' can be used. The response to that particular command will also be preceded by the signature, and the corresponding lines will be between brackets:

```
▶ 1700#GET /V1/EDID.*
◀ {1700
◀ pr /V1/EDID.EdidStatus=F49:E1;F49:E2;F49:E3;F49:E4
◀ m- /V1/EDID:copy
◀ m- /V1/EDID:delete
◀ m- /V1/EDID:reset
◀ m- /V1/EDID:switch
◀ m- /V1/EDID:switchAll
◀ }
```

INFO: The lines of the signature are also Cr and Lf terminated.

8.4.9. Subscription

DEFINITION: Subscription to a node means that the user will get a notification if a property of the node changes.

A user can subscribe to any node. These notifications are asynchronous messages and are useful to keep the client application up to date, without having to periodically poll the node to detect a changed property. When the user does not want to be informed about the changes anymore, he can simply unsubscribe from the node.

DIFFERENCE: From firmware version v2.11.0, subscription to a nonexistent path is possible, and thus there will be no error message upon mistyping a path.

ATTENTION! The subscriptions are handled separately for connections. Hence, if the connection is terminated, all registered subscriptions are deleted. After reopening a connection all subscribe commands have to be sent in order to get the notifications of the changes on that connection.

Subscribe to a Node

```
▶ OPEN /V1/MEDIA/VIDEO
◀ o- /V1/MEDIA/VIDEO
```

Get the Active Subscriptions

```
▶ OPEN
◀ o- /V1/MANAGEMENT/LABEL
◀ o- /V1/MEDIA/VIDEO/XP/O1/SWITCHABLE
◀ o- /V1/MEDIA/VIDEO/XP/O2/SWITCHABLE
◀ o- /V1/MEDIA/VIDEO/XP/I5
```

Subscribe to Multiple Nodes

```
▶ OPEN /V1/MEDIA/VIDEO/*
◀ o- /V1/MEDIA/VIDEO/*
```

Unsubscribe from a Node

```
▶ CLOSE /V1/MEDIA/VIDEO
◀ c- /V1/MEDIA/VIDEO
```

Unsubscribe from Multiple Nodes

```
▶ CLOSE /V1/MEDIA/VIDEO/*
◀ c- /V1/MEDIA/VIDEO/*
```

8.4.10. Notifications about the Changes of the Properties

When the value of a property is changed, and the user is subscribed to the node that the property belongs to, an asynchronous notification is generated. This notification is called the 'change message'. The format of such a message is very similar to the response for the GET command:

```
◀ CHG /EDID.EdidStatus=F48:E1
```

A Short Example of How to Use the Subscription

There are two independent users controlling the device through two independent connections (**Connection #1** and **Connection #2**). The events in the rows occur after each other.

▶ OPEN /V1/MEDIA/AUDIO/O3 ◀ o- /V1/MEDIA/AUDIO/O3 ▶ GET /V1/MEDIA/AUDIO/O3.VolumePercent ◀ pm /V1/MEDIA/AUDIO/O3.VolumePercent=100.00	connection #1
▶ GET /V1/MEDIA/AUDIO/O3.VolumePercent ◀ pw /V1/MEDIA/AUDIO/O3.VolumePercent=100.00 ◀ SET /V1/MEDIA/AUDIO/O3.VolumePercent=50.00 ◀ pw /V1/MEDIA/AUDIO/O3.VolumePercent=50.00	connection #2
◀ CHG /V1/MEDIA/AUDIO/O3.VolumePercent=50.00	connection #1

The first user (**Connection #1**) set a subscription to a node. Later the other user (**Connection #2**) made a change, and thanks to the subscription, the first user got a notification about the change.

8.5. System Commands

8.5.1. Setting the Device Label

INFO: The device label can be changed to a custom text in the [Status](#) tab of the LDC software.

Command and Response *#devicelabel #label*

- ▶ SET /V1/MANAGEMENT/LABEL.DeviceLabel=<custom_name>
- ◀ pw /V1/MANAGEMENT/LABEL.DeviceLabel=<custom_name>

The Device Label can be 49 characters long and ASCII characters are allowed. Longer names are truncated.

Example

- ▶ SET /V1/MANAGEMENT/LABEL.DeviceLabel=UCX_Conference_room1
- ◀ pw /V1/MANAGEMENT/LABEL.DeviceLabel=UCX_Conference_room1

8.5.2. Resetting the Device

The switcher can be restarted – the current connections will be terminated.

Command and Response *#reboot #restart*

- ▶ CALL /V1/SYS:restart()
- ◀ mO /V1/SYS:restart=

Example

- ▶ CALL /V1/SYS:restart()
- ◀ mO /V1/SYS:restart=

8.5.3. Restoring the Factory Default Settings

Command and Response

- ▶ CALL /V1/SYS:factoryDefaults()
- ◀ mO /V1/SYS:factoryDefaults=

Example

- ▶ CALL /V1/SYS:factoryDefaults()
- ◀ mO /V1/SYS:factoryDefaults=

The device is restarted, current connections are terminated, and the default settings are restored. See the complete list in the [Factory Default Settings](#) section.

#factory

8.5.4. Querying the Firmware Package Version

Command and Response *#firmwareversion*

- ▶ GET /V1/MANAGEMENT/UID/PACKAGE.Version
- ◀ pr /V1/MANAGEMENT/UID/PACKAGE.Version=<firmware_version>

Example

- ▶ GET V1/MANAGEMENT/UID/PACKAGE.Version
- ◀ pr /V1/MANAGEMENT/UID/PACKAGE.Version=1.0.0b2

8.5.5. Control Lock

Enable/disable the operation of the front panel buttons.

Command and Response *#lockbutton #buttonlock*

- ▶ SET /V1/MANAGEMENT/UI.ControlLock=<lock_status>
- ◀ pw /V1/MANAGEMENT/UI.ControlLock=<lock_status>

Parameters

Parameter	Parameter description	Values	Value description
<lock_status>	Front panel button locking status	None	All functions of the front panel button are enabled.
		Locked	The front panel buttons are locked and can be unlocked by button combination (Control Lock).
		Force locked	The front panel buttons are locked and cannot be unlocked by button combination, only in LDC (on the Status tab) or using the LW3 command.

Example

- ▶ SET /V1/MANAGEMENT/UI.ControlLock=force locked
- ◀ pw /V1/MANAGEMENT/UI.ControlLock=force locked

8.5.6. Setting the Current Time

Command and Response *#time*

- ▶ CALL /V1/MANAGEMENT/DATETIME:setTime(<current_time>)
- ◀ mO /V1/MANAGEMENT/DATETIME:setTime=

Parameters

<current_time>: The new router time in ISO 8601 date time format.

Example

- ▶ CALL /V1/MANAGEMENT/DATETIME:setTime(2020-11-01T04:39:54.000Z)
- ◀ mO /V1/MANAGEMENT/DATETIME:setTime=

8.5.7. Identifying the Device

Calling the method makes the status LEDs blink for 10 seconds. The feature helps find the device physically.

Command and Response *#identifyme*

- ▶ CALL /V1/MANAGEMENT/UI:identifyMe()
- ◀ mO /V1/MANAGEMENT/UI:identifyMe=

Example

- ▶ CALL /V1/MANAGEMENT/UI:identifyMe()
- ◀ mO /V1/MANAGEMENT/UI:identifyMe=

8.5.8. Toggling the Dark Mode Setting

The LEDs of the device can be switched off if their light could be annoying. In Dark mode, all LEDs are switched off, except for the LEDs of the RJ45 connectors. *#darkmode*

Command and Response

- ▶ SET /V1/MANAGEMENT/UI/DARKMODE.Enable=<mode_state>
- ◀ pw /V1/MANAGEMENT/UI/DARKMODE.Enable=<mode_state>

Parameters

If the <mode_state> parameter is **true** (or **1**), the Dark mode function is **enabled**, if the parameter is **false** (or **0**), the function is **disabled**.

Example

- ▶ SET /V1/MANAGEMENT/UI/DARKMODE.Enable=true
- ◀ pw /V1/MANAGEMENT/UI/DARKMODE.Enable=true

8.5.9. Setting the Delay of the Dark Mode Setting

The Dark mode can be enabled right away, or after a certain time. Thus, the mode is enabled if no buttons are pressed for a while. Pressing any button brings back the status info on the LEDs without performing the function of the button itself. The delay time can be set by this command.

Command and Response

- ▶ SET /V1/MANAGEMENT/UI/DARKMODE.Delay=<delay_time>
- ◀ pw /V1/MANAGEMENT/UI/DARKMODE.Delay=<delay_time>

Parameters

The <delay_time> parameter means seconds, and the default value is 60. If set to 0, no delay is applied, and the Dark mode can be enabled immediately by the **DarkModeEnable** property. This delay affects the **wakeFromDarkMode** method as well.

Example

- ▶ SET /V1/MANAGEMENT/UI/DARKMODE.Delay=10
- ◀ pw /V1/MANAGEMENT/UI/DARKMODE.Delay=10

8.6. Video Port Settings - General

8.6.1. Switching Video Input

Command and Response

- ▶ CALL /V1/MEDIA/VIDEO/XP:switch(<in>:<out>)
- ◀ mO /V1/MEDIA/VIDEO/XP:switch=

Example

- ▶ CALL /V1/MEDIA/VIDEO/XP:switch(I5:O1)
- ◀ mO /V1/MEDIA/VIDEO/XP:switch=

INFO: When using the '0' value as an input, the input will be disconnected and no signal will appear on the output.

ATTENTION! Video crosspoint has a limitation: I1 and I5 ports are not available at the same time, only one of them can be selected to any output. When one of the outputs is switched to I1 or I5, the other output can not be switched to I1 or I5. In this case the switch command returns an error message.

Example

- ▶ GET /V1/MEDIA/VIDEO/XP/O1.ConnectedSource
- ◀ pw /V1/MEDIA/VIDEO/XP/O1.ConnectedSource=I5
- ▶ GET /V1/MEDIA/VIDEO/XP/O2.ConnectedSource
- ◀ pw /V1/MEDIA/VIDEO/XP/O2.ConnectedSource=I5
- ▶ CALL /V1/MEDIA/VIDEO/XP:switch(I1:O1)
- ◀ mE /V1/MEDIA/VIDEO/XP:switch %E006: Illegal operation

8.6.2. Switching an Input to All Outputs

Command and Response

- ▶ CALL /V1/MEDIA/VIDEO/XP:switchAll(<input>)
- ◀ mO /V1/MEDIA/VIDEO/XP:switchAll=

Example

- ▶ CALL /V1/MEDIA/VIDEO/XP:switchAll(I1)
- ◀ mO /V1/MEDIA/VIDEO/XP:switchAll=

8.6.3. Locking the Video Port

Command and Response

- ▶ SET /V1/MEDIA/VIDEO/XP/<port>.Lock=<locked_state>
- ◀ pw /V1/MEDIA/VIDEO/XP/<port>.Lock=<locked_state>

Parameters

Parameter	Parameter description	Values	Value description
<locked_state>	Locked state	true	The port is locked
		false	The port is unlocked

Example

- ▶ SET /V1/MEDIA/VIDEO/XP/I2.Lock=false
- ◀ pw /V1/MEDIA/VIDEO/XP/I2.Lock=false

8.6.4. Muting the Video Port

Command and Response

- ▶ SET /V1/MEDIA/VIDEO/XP/<port>.Mute=<muted_state>
- ◀ pw /V1/MEDIA/VIDEO/XP/<port>.Mute=<muted_state>

Parameters

Parameter	Parameter description	Values	Value description
<muted_state>	Muted state	true	The port is locked.
		false	The port is unlocked.

Example

- ▶ SET /V1/MEDIA/VIDEO/XP/I2.Mute=false
- ◀ pw /V1/MEDIA/VIDEO/XP/I2.Mute=false

8.6.5. Setting the Autoselect Policy

Command and Response

- ▶ SET /V1/MEDIA/VIDEO/AUTOSELECT/<out>.Policy=<autoselect_mode>
- ◀ pw /V1/MEDIA/VIDEO/AUTOSELECT/<out>.Policy=<autoselect_mode>

Parameters

Parameter	Parameter description	Values	Value description
<autoselect_mode>	The autoselect policy	Off	The autoselect function is disabled.
		Last Detect	It is always the last attached input that is automatically switched to the output..
		First Detect	The first active video input is selected.

Example

- ▶ SET /V1/MEDIA/VIDEO/AUTOSELECT/O2.Policy=First detect
- ◀ pw /V1/MEDIA/VIDEO/AUTOSELECT/O2.Policy=First detect

8.6.6. Changing the Autoselect Included Input Ports

Command and Response

- ▶ SET /V1/MEDIA/VIDEO/AUTOSELECT/<out>/<in>.Included=<state>
- ◀ pw /V1/MEDIA/VIDEO/AUTOSELECT/<out>/<in>.Included=<state>

Parameters

Parameter	Parameter description	Values	Value description
<state>	The chosen input is ignored in the autoselect process or not.	true	The port is included in autoselect.
		false	The autoselect function ignores that port.

Example

- ▶ SET /V1/MEDIA/VIDEO/AUTOSELECT/O2/I1.Included=false
- ◀ pw /V1/MEDIA/VIDEO/AUTOSELECT/O2/I1.Included=false

8.6.7. Changing the Input Port Priority

Command and Response

- ▶ SET /V1/MEDIA/VIDEO/AUTOSELECT/<out>/<in>.Priority=<prio_num>
- ◀ pw /V1/MEDIA/VIDEO/AUTOSELECT/<out>/<in>.Priority=<prio_num>

Parameters

The <prio> parameter means the priority number from 1 to 100, equal numbers are allowed. Inputs can have different priorities in relation to two or more outputs. Therefore, the output port number is part of the node path of input port priorities.

Example

- ▶ SET /V1/MEDIA/VIDEO/AUTOSELECT/O2/I2.Priority=51
- ◀ pw /V1/MEDIA/VIDEO/AUTOSELECT/O2/I2.Priority=51

8.6.8. Querying the Connected Source

Command and Response

- ▶ GET /V1/MEDIA/VIDEO/XP/<out>.ConnectedSource
- ◀ pw /V1/MEDIA/VIDEO/XP/<out>.ConnectedSource=<in>

Example

- ▶ GET /V1/MEDIA/VIDEO/XP/O3.ConnectedSource
- ◀ pw /V1/MEDIA/VIDEO/XP/O3.ConnectedSource=I2

8.6.9. Querying the Input Switching Capability

Video crosspoint has a limitation: I1 or I5 ports can not be selected to any output at the same time. **Busy** value of the switchable property refers to the limitation.

Command and Response

- ▶ GET /V1/MEDIA/VIDEO/XP/<out>/SWITCHABLE.<in>
- ◀ pr /V1/MEDIA/VIDEO/XP/<out>/SWITCHABLE.<in>=<switchable_state>

Parameters

Parameter	Parameter description	Values	Value description
<switchable_state>	The chosen input can be switched to the output or not.	OK	The connection of the chosen input and output is allowed.
		Busy	The chosen input can not be switched to the output.

Example

- ▶ GET /V1/MEDIA/VIDEO/XP/O2/SWITCHABLE.I1
- ◀ pr /V1/MEDIA/VIDEO/XP/O2/SWITCHABLE.I1=Busy

8.6.10. Querying the Connected Destinations

Command and Response

- ▶ GET /V1/MEDIA/VIDEO/XP/<n>.ConnectedDestinations
- ◀ pr /V1/MEDIA/AUDIO/XP/<in>.ConnectedDestinations=<out>

Example

- ▶ GET /V1/MEDIA/VIDEO/XP/I3.ConnectedDestinations
- ◀ pr /V1/MEDIA/VIDEO/XP/I3.ConnectedDestinations=O1;O2

8.6.11. Querying the Video Signal Presence

Command and Response

- ▶ GET /V1/MEDIA/VIDEO/<port>.SignalPresent
- ◀ pr /V1/MEDIA/VIDEO/<port>.SignalPresent=<state>

Parameters

Parameter	Parameter description	Values	Value description
<state>	This property gives a feedback about the current signal presence of the port.	true	The video signal is present.
		false	The video signal is not present.

Example

- ▶ GET /V1/MEDIA/VIDEO/I1.SignalPresent
- ◀ pr /V1/MEDIA/VIDEO/I1.SignalPresent=false

8.6.12. HDCP Setting (Input Port)

HDCP capability can be set on the input ports, thus non-encrypted content can be seen on a non-HDCP compliant display. See more information in the [HDCP Management](#) section.

ATTENTION! HDCP 2.2 signal handling is limited to up to two input ports at the same time.

Command and Response #hdc

- ▶ SET /V1/MEDIA/VIDEO/<in>/HDCP.AllowedHdcpVersion=<allowed_hdcp>
- ◀ pw /V1/MEDIA/VIDEO/<in>/HDCP.AllowedHdcpVersion=<allowed_hdcp>

Parameters

Parameter	Parameter description	Values	Value description
<allowed_hdcp>	The input port reports the HDCP capability.	HDCP 1.4	The input port reports HDCP 1.4 capability.
		HDCP 2.2	The input port reports HDCP 2.2 capability.
		Off	The input port reports non-HDCP compliance.

Example

- ▶ SET /V1/MEDIA/VIDEO/I1/HDCP.AllowedHdcpVersion=HDCP 1.4
- ◀ pw /V1/MEDIA/VIDEO/I1/HDCP.AllowedHdcpVersion=HDCP 1.4

8.6.13. HdcpMode

HDCP capability can be set to Auto/Always on the output ports, thus non-encrypted content can be transmitted to a non-HDCP compliant display. See more information in the [HDCP Management](#) section.

Command and Response *#hdcp*

- ▶ SET /V1/MEDIA/VIDEO/<out>.HdcpMode=<hdcp_mode>
- ◀ pw /V1/MEDIA/VIDEO/<out>.HdcpMode=<hdcp_mode>

Parameters

Parameter	Parameter description	Values	Value description
<hdcp_mode>	HDCP encryption setting on the output port	Auto	The encryption is enabled on the output port if the signal on the input port is encrypted.
		Always	The outgoing signal is HDCP-encrypted.

Example

- ▶ SET /V1/MEDIA/VIDEO/O1/HDCP.HdcpMode=Auto
- ◀ pw /V1/MEDIA/VIDEO/O1/HDCP.HdcpMode=Auto

8.6.14. OutputSignalType

Command and Response *#signaltype*

- ▶ SET /V1/MEDIA/VIDEO/<out>.OutputSignalType=<signal_type>
- ◀ pw /V1/MEDIA/VIDEO/<out>.OutputSignalType=<signal_type>

Parameters

Parameter	Parameter description	Values	Value description
<signal_type>	Signal type setting	Auto	The outgoing signal type is HDMI.
		DVI	The outgoing signal type is DVI.

Example

- ▶ SET /V1/MEDIA/VIDEO/O1.OutputSignalType=Auto
- ◀ pw /V1/MEDIA/VIDEO/O1.OutputSignalType=Auto

8.6.15. EmbeddedAudioPresent

- ▶ GET /V1/MEDIA/VIDEO/<port>.EmbeddedAudioPresent
- ◀ pr /V1/MEDIA/VIDEO/<port>.EmbeddedAudioPresent=<embedded_state>

Parameters

Parameter	Parameter description	Values	Value description
<embedded_state>	It shows if the video contains audio or not.	true	There is embedded audio in the video signal.
		false	There is no embedded audio in the video signal.

Example

- ▶ GET /V1/MEDIA/VIDEO/I2.EmbeddedAudioPresent
- ◀ pr /V1/MEDIA/VIDEO/I2.EmbeddedAudioPresent=false

8.6.16. EmbeddedAudioMute

- ▶ SET /V1/MEDIA/VIDEO/<port>.EmbeddedAudioMute=<mute_state>
- ◀ pw /V1/MEDIA/VIDEO/<port>.EmbeddedAudioMute=<mute_state>

Parameters

Parameter	Parameter description	Values	Value description
<mute_state>	It shows if the embedded audio is muted or not.	true	The embedded audio is muted.
		false	The embedded audio is unmuted.

Example

- ▶ SET /V1/MEDIA/VIDEO/O1.EmbeddedAudioMute=false
- ◀ pw /V1/MEDIA/VIDEO/O1.EmbeddedAudioMute=false

8.6.17. Output5VMode

The 5V power towards the sink can be enabled or disabled as follows:

Command and Response

- ▶ SET /V1/MEDIA/VIDEO/<out>.Output5VMode=<5V_pwr>
- ◀ pw /V1/MEDIA/VIDEO/<out>.Output5VMode=<5V_pwr>

Parameters

Parameter	Parameter description	Value	Value description
<5V_pwr>	5V power towards the sink	On	Enable 5V power on HDMI port
		Off	Disable 5V power on HDMI port

Example

- ▶ SET /V1/MEDIA/VIDEO/O1.Output5VMode=On
- ◀ pw /V1/MEDIA/VIDEO/O1.Output5VMode=On

8.6.18. HDCP Capability (Output Port)

HDCP capability of the connected sink device can be queried at each output port. See more information in the [HDCP Management](#) section.

Command and Response *#hdcp*

- ▶ GET·/V1/MEDIA/VIDEO/<out>/HDCP/SinkMaxHdcpVersion=<hdcp_ver>
- ◀ pr·/V1/MEDIA/VIDEO/<out>/HDCP/SinkMaxHdcpVersion=<hdcp_ver>

Parameters

Parameter	Parameter description	Values	Value description
<hdcp_ver>	The HDCP capability is reported from the sink.	N/A	Sink is not connected or the HDCP-capability cannot be determined.
		None	The connected sink is non-HDCP compliant.
		HDCP 1.4	The connected sink supports HDCP 1.4 capability.
		HDCP 2.2	The connected sink supports HDCP 2.2 capability.

Example

- ▶ GET /V1/MEDIA/VIDEO/O1/HDCP/SinkMaxHdcpVersion=HDCP 1.4
- ◀ pr /V1/MEDIA/VIDEO/O1/HDCP/SinkMaxHdcpVersion=HDCP 1.4

8.6.19. HDCP Setting (Output Port)

The maximum allowed HDCP encryption can be queried at each output port. See more information in the [HDCP Management](#) section.

ATTENTION! HDCP 2.2 signal handling is limited when 3 outputs are available: O1 and O2 ports support up to HDCP 2.2, O3 port supports HDCP 1.4.

Command and Response *#hdcp*

- ▶ GET·/V1/MEDIA/VIDEO/<out>/HDCP.AllowedHdcpVersion=<allowed_hdcp>
- ◀ pr·/V1/MEDIA/VIDEO/<out>/HDCP.AllowedHdcpVersion=<allowed_hdcp>

Parameters

Parameter	Parameter description	Values	Value description
<allowed_hdcp>	The maximum allowed HDCP encryption on the output port	HDCP 1.4	HDCP 1.4 is supported.
		HDCP 2.2	HDCP 2.2 and HDCP 1.4 are supported.

Example

- ▶ GET /V1/MEDIA/VIDEO/O1/HDCP/AllowedHdcpVersion=HDCP 1.4
- ◀ pr /V1/MEDIA/VIDEO/O1/HDCP/AllowedHdcpVersion=HDCP 1.4

8.7. Welcome Screen Settings

For details about the Welcome screen feature, please see the [Welcome Screen](#) section.

8.7.1. Displaying the Welcome Screen Image

Command and Response *#welcomescreen*

- ▶ SET·/V1/MEDIA/VIDEO/I5/WELCOMESCREEN.ImageEnabled=<image_state>
- ◀ pw·/V1/MEDIA/VIDEO/I5/WELCOMESCREEN.ImageEnabled=<image_state>

Parameters

Parameter	Values	Value description
<image_state>	true	The welcome screen image is displayed.
	false	The welcome screen image is not displayed.

Example

- ▶ SET /V1/MEDIA/VIDEO/I5/WELCOMESCREEN.ImageEnabled=true
- ◀ pw /V1/MEDIA/VIDEO/I5/WELCOMESCREEN.ImageEnabled=true

8.7.2. Displaying the Welcome Screen Text

Command and Response

- ▶ SET·/V1/MEDIA/VIDEO/I5/WELCOMESCREEN.MessageEnabled=<text_state>
- ◀ pw·/V1/MEDIA/VIDEO/I5/WELCOMESCREEN.MessageEnabled=<text_state>

Parameters

Parameter	Values	Value description
<text_state>	true	The welcome screen text is displayed.
	false	The welcome screen text is not displayed.

Example

- ▶ SET /V1/MEDIA/VIDEO/I5/WELCOMESCREEN.MessageEnabled=false
- ◀ pw /V1/MEDIA/VIDEO/I5/WELCOMESCREEN.MessageEnabled=false

8.7.3. Setting the Welcome Screen Text

Command and Response

- ▶ SET /V1/MEDIA/VIDEO/I5/WELCOMESCREEN.MessageText=<text>
- ◀ pw /V1/MEDIA/VIDEO/I5/WELCOMESCREEN.MessageText=<text>

Parameters

The <text> may consist of letters (A-Z) and (a-z), hyphen (-), underscore (_), numbers (0-9), space () and dot (.). Max length: 63 characters. Longer names are truncated.

Example

- ▶ SET /V1/MEDIA/VIDEO/I5/WELCOMESCREEN.MessageText=info
- ◀ pw /V1/MEDIA/VIDEO/I5/WELCOMESCREEN.MessageText=info

8.7.4. Resetting the Welcome Screen Image

This command restores the original welcome screen image.

Command and Response

- ▶ CALL /V1/MEDIA/VIDEO/I5/WELCOMESCREEN:resetImage()
- ◀ mO /V1/MEDIA/VIDEO/I5/WELCOMESCREEN:resetImage=

Example

- ▶ CALL /V1/MEDIA/VIDEO/I5/WELCOMESCREEN:resetImage()
- ◀ mO /V1/MEDIA/VIDEO/I5/WELCOMESCREEN:resetImage=

8.8. Video Port Settings - USB-C Related Commands

8.8.1. Restarting the Link Training

This method is equal to pulling the USB-C connector out and plugging it in again.

Command and Response *#linktraining*

- ▶ CALL /V1/MEDIA/VIDEO/<in>/DP:restartLinkTraining()
- ◀ mO /V1/MEDIA/VIDEO/<in>/DP:restartLinkTraining=

Example

- ▶ CALL /V1/MEDIA/VIDEO/I1/DP:restartLinkTraining()
- ◀ mO /V1/MEDIA/VIDEO/I1/DP:restartLinkTraining=

8.9. CEC Command Sending

The device is able to send Consumer Electronics Control (CEC) commands. This feature is for remote controlling the source or sink device. CEC is a bi-directional communication via the HDMI cable.

ATTENTION! To have a successful CEC command processing, the connected HDMI device must support CEC. #cec

8.9.1. Simple CEC Code Sending

This command is for sending simple CEC commands to the connected sink device.

The commands can be sent by the following two formats – defined in the header:

- **text/plain:** hexa strings (as seen in the example)
- **application/octet-stream:** binary data that allows sending a file with the desired codes

Command and Response

- ▶ `CALL /V1/MEDIA/VIDEO/<out>/CEC:send(<command>)`
- ◀ `mO /V1/MEDIA/VIDEO/<out>/CEC:send=OK`

Parameters

Parameter	Parameter description	Values	Value description
<port>	Video output port	01-02-03	Video output port number
<command> *	Two-digit-long hexa code to control the sink device	446D	Power on
		446C	Power off
		36	Standby
		446901	Select input 1
		446902	Select input 2
		446903	Select input 3

* The supported list of <commands> depends on the connected sink device.

INFO: For the full list of commands supported by the UCX switcher, please see the next page.

Example

- ▶ `CALL /V1/MEDIA/VIDEO/02/CEC:send(446D)`
- ◀ `mO /V1/MEDIA/VIDEO/02/CEC:send=OK`

8.9.2. Remote Control Code Sending

This command is for sending the so-called 'push-button-commands'. There is a range within the CEC commands for this purpose, e.g. volume up/down. With this method one <command> is put between the 0x44 and 0x45 opcodes in the background.

Request and Response

- ▶ `CALL /V1/MEDIA/VIDEO/<port>/CEC:sendUserControlClick(<command>)`
- ◀ `mO /V1/MEDIA/VIDEO/<port>/CEC:sendUserControlClick=OK`

Parameters

Parameter	Parameter description	Values	Value description
<port>	Video output port	01-02-03	Video output port number
<command> *	A hexa code to control the sink device	446D	Power on
		446C	Power off

* The supported list of <commands> depends on the connected sink device.

INFO: For the full list of commands supported by the UCX switcher, please see the next page.

Example

- ▶ `CALL /V1/MEDIA/VIDEO/02/CEC:sendUserControlClick(446D)`
- ◀ `mO /V1/MEDIA/VIDEO/02/CEC:sendUserControlClick=OK`

Command List

Command	Hexa	Binary
Ok	4400	0100010000000000
Up	4401	0100010000000001
Down	4402	0100010000000010
Left	4403	0100010000000011
Right	4404	0100010000000100
Root menu	4409	0100010000001001
Setup menu	440A	0100010000001010
Contents menu	440B	0100010000001011
Favorite menu	440C	0100010000001100
Back	440D	0100010000001101
Media top menu	4410	0100010000010000
Media context menu	4411	0100010000010001
Number 0	4420	0100010000100000
Number 1	4421	0100010000100001
Number 2	4422	0100010000100010
Number 3	4423	0100010000100011
Number 4	4424	0100010000100100
Number 5	4425	0100010000100101
Number 6	4426	0100010000100110
Number 7	4427	0100010000100111
Number 8	4428	0100010000101000
Number 9	4429	0100010000101001
Dot	442A	0100010000101010
Enter	442B	0100010000101011
Clear	442C	0100010000101100
Channel up	4430	0100010000000000
Channel down	4431	0100010000110001
Sound select	4433	0100010000110011
Input select	4434	0100010000110100
Display info	4435	0100010000110101
Page up	4437	0100010000110111
Page down	4438	0100010000111000
Power legacy	4440	0100010001000000
Volume up	4441	0100010001000001
Volume down	4442	0100010001000010
Mute toggle	4443	0100010001000011
Play	4444	0100010001000100
Stop	4445	0100010001000101
Pause	4446	0100010001000110

Command	Hexa	Binary
Record	4447	0100010001000111
Rewind	4448	0100010001001000
Fast forward	4449	0100010001001001
Eject	444A	0100010001001010
Skip forward	444B	0100010001001011
Skip backward	444C	0100010001001100
3D mode	445A	0100010001011010
Stop record	444D	0100010001001101
Play forward	446024	010001000110000000100100
Play reverse	446020	010001000110000000100000
Stop function	4464	0100010001100100
Mute	4465	0100010001100101
Unmute	4466	0100010001100110
Select next media	446800	010001000110100000000000
Select media 1	446801	010001000110100000000001
Select media 2	446802	010001000110100000000010
Select media 3	446803	010001000110100000000011
Select media 4	446804	010001000110100000000100
Select media 5	446805	010001000110100000000101
Select next input	446900	010001000110100100000000
Select input 1	446901	010001000110100100000001
Select input 2	446902	010001000110100100000010
Select input 3	446903	010001000110100100000011
Select input 4	446904	010001000110100100000100
Select input 5	446905	010001000110100100000101
Power toggle	446B	0100010001101011
Power on	446D	0100010001101101
Power off	446C	0100010001101100
Standby	36	00110110
Image view on	04	00000100
Text view on	0D	00001101
F1	4471	0100010001110001
F2	4472	0100010001110010
F3	4473	0100010001110011
F4	4474	0100010001110100
Clear OSD	6480	0110010010000000
Get CEC version	9F	10011111

8.10. Audio Port Settings

INFO: Audio port numbers may differ depending on the model. For more information, see the [Port Numbering](#) section.

8.10.1. Switching the Audio Input

Command and Response

- ▶ `CALL /V1/MEDIA/AUDIO/XP:switch(<audio_in>:03)`
- ◀ `mO /V1/MEDIA/AUDIO/XP:switch=`

Parameters

Parameter	Parameter description	Values	Value description
<audio_in>	Audio input port	I1-I4	Audio input port number

Example

- ▶ `CALL /V1/MEDIA/AUDIO/XP:switch(I2:03)`
- ◀ `mO /V1/MEDIA/AUDIO/XP:switch=`

INFO: When using the '0' value as an input, the input will be disconnected and no signal will appear on the output.

ATTENTION! When I5 is selected for video source, the de-embedded audio of the I1 is not available, because the video crosspoint has a limitation: I1 and I5 ports are not available at the same time, only one of them can be selected to any output. For more details about it, see the port diagram in the [Audio Interface](#) section.

8.10.2. Querying the Connected Source

Command and Response

- ▶ `GET /V1/MEDIA/AUDIO/XP/03.ConnectedSource`
- ◀ `pw /V1/MEDIA/AUDIO/XP/03.ConnectedSource=<audio_in>`

Parameters

Parameter	Parameter description	Values	Value description
<audio_in>	Audio input port	I1-I4	Audio input port number

Example

- ▶ `GET /V1/MEDIA/AUDIO/XP/03.ConnectedSource`
- ◀ `pw /V1/MEDIA/AUDIO/XP/03.ConnectedSource=I2`

8.10.3. Querying the Connected Destinations

Command and Response

- ▶ `GET /V1/MEDIA/AUDIO/XP/<audio_in>.ConnectedDestinations`
- ◀ `pr /V1/MEDIA/AUDIO/XP/<audio_in>.ConnectedDestinations=`

Parameters

Parameter	Parameter description	Values	Value description
<audio_in>	Audio input port	I1-I4	Audio input port number

Example

- ▶ `GET /V1/MEDIA/AUDIO/XP/I3.ConnectedDestinations`
- ◀ `pr /V1/MEDIA/AUDIO/XP/I3.ConnectedDestinations=`

8.10.4. Setting the Autoselect Operation Mode

Command and Response

- ▶ `SET /V1/MEDIA/AUDIO/AUTOSELECT/03.Policy=<op_mode>`
- ◀ `pw /V1/MEDIA/AUDIO/AUTOSELECT/03.Policy=<op_mode>`

Parameters

Parameter	Parameter description	Values	Value description
<op_mode>	Operation mode	Follow video	Follows the video crosspoint state automatically.
		Off	Autoselect function is disabled.

Example

- ▶ `SET /V1/MEDIA/AUDIO/AUTOSELECT/03.Policy=Follow video`
- ◀ `pw /V1/MEDIA/AUDIO/AUTOSELECT/03.Policy=Follow video`

8.10.5. Setting the Followed Video Port to Autoselect

Command and Response

- ▶ `SET /V1/MEDIA/AUDIO/AUTOSELECT/03.VideoFollowPort=<out>`
- ◀ `pw /V1/MEDIA/AUDIO/AUTOSELECT/03.VideoFollowPort=<out>`

Example

- ▶ `SET /V1/MEDIA/AUDIO/AUTOSELECT/03.VideoFollowPort=01`
- ◀ `pw /V1/MEDIA/AUDIO/AUTOSELECT/03.VideoFollowPort=01`

8.10.6. Enabling/Disabling the Dante USB Sound Card

DIFFERENCE: This command is only available for the UCX-4x3-HC40-BD model.

This command enables or disables the Dante USB Sound Card, toggling the Dante input functionality. When enabled, the Dante audio input devices will appear as USB audio inputs on the host computer.

INFO: Dante input devices can only be detected by the computer when the USB sound card is enabled.

Command and Response

- ▶ SET /V1/SYS/BD_DANTE_ADDON.Enabled=<status>
- ◀ pw /V1/SYS/BD_DANTE_ADDON.Enabled=<status>

Parameters

Parameter	Parameter description	Values
<status>	Enables or disables the USB sound card. Default value is true .	true
		false

Example

- ▶ SET /V1/SYS/BD_DANTE_ADDON.Enabled=true
- ◀ pw /V1/SYS/BD_DANTE_ADDON.Enabled=true

8.10.7. Setting the Audio Device Type for the Dante Input

DIFFERENCE: This command is only available for the UCX-4x3-HC40-BD model.

This command allows setting the type of audio input device through the Dante channel.

Command and Response

- ▶ SET /V1/MEDIA/AUDIO/DANTE_IN.AudioDeviceType=<device_type>
- ◀ pw /V1/MEDIA/AUDIO/DANTE_IN.AudioDeviceType=<device_type>

Parameters

Parameter	Parameter description	Values
<device_type>	Sets the type of the audio input device	Speakerphone
		Echo-canceling speakerphone
		Echo-suppressing speakerphone

Example

- ▶ SET /V1/MEDIA/AUDIO/DANTE_IN.AudioDeviceType=Speakerphone
- ◀ pw /V1/MEDIA/AUDIO/DANTE_IN.AudioDeviceType=Speakerphone

8.10.8. Locking the Audio Port

Command and Response

- ▶ SET /V1/MEDIA/AUDIO/XP/<audio_port>.Lock=<locked_state>
- ◀ pw /V1/MEDIA/AUDIO/XP/<audio_port>.Lock=<locked_state>

Parameters

Parameter	Parameter description	Values	Value description
<audio_port>	Audio port	I1-I4	Audio input port number
		O3	Audio output port number
<locked_state>	Locked state	true	The port is locked
		false	The port is unlocked

Example

- ▶ SET /V1/MEDIA/AUDIO/XP/I2.Lock=false
- ◀ pw /V1/MEDIA/AUDIO/XP/I2.Lock=false

8.10.9. Muting the Audio Port 1.

INFO: Suspends the connection of the chosen port (no signal is forwarded).

Command and Response

- ▶ SET /V1/MEDIA/AUDIO/XP/<audio_port>.Mute=<muted_state>
- ◀ pw /V1/MEDIA/AUDIO/XP/<audio_port>.Mute=<muted_state>

Parameters

Parameter	Parameter description	Values	Value description
<audio_port>	Audio port	I1-I4	Audio input port number
		O3	Audio output port number
<muted_state>	Muted state	true	The port is muted.
		false	The port is unmuted.

Example

- ▶ SET /V1/MEDIA/AUDIO/XP/I2.Mute=false
- ◀ pw /V1/MEDIA/AUDIO/XP/I2.Mute=false

INFO: All inputs and analog output ports have a mute property in the audio XP (e.g. /V1/MEDIA/AUDIO/XP/I1.Mute). Outputs have a separate mute function within the port node as well:

- /V1/MEDIA/VIDEO/XP/O1.EmbeddedAudioMute
- /V1/MEDIA/VIDEO/XP/O2.EmbeddedAudioMute
- /V1/MEDIA/AUDIO/O3.Mute

8.10.10. Muting the Audio Port 2.

INFO: The volume of the analog audio output is set to low.

Command and Response

- ▶ SET /V1/MEDIA/AUDIO/O3.Mute=<muted_state>
- ◀ pw /V1/MEDIA/AUDIO/O3.Mute=<muted_state>

Parameters

Parameter	Parameter description	Values	Value description
<audio_port>	Audio port	I1-I4	Audio input port number
		O3	Audio output port number
<muted_state>	Muted state	true	The port is muted.
		false	The port is unmuted.

Example

- ▶ SET /V1/MEDIA/AUDIO/O3.Mute=true
- ◀ pw /V1/MEDIA/AUDIO/O3.Mute=true

8.10.11. Querying the Audio Signal Presence

Command and Response

- ▶ GET /V1/MEDIA/AUDIO/<audio_port>.SignalPresent
- ◀ pr /V1/MEDIA/AUDIO/<audio_port>.SignalPresent=<signal_state>

Parameters

Parameter	Parameter description	Values	Value description
<audio_port>	Audio port	I1-I4	Audio input port number
		O3	Audio output port number
<signal_state>	Signal presence	true	The audio signal is present.
		false	No audio signal is present.

Example

- ▶ GET /V1/MEDIA/AUDIO/I1.SignalPresent
- ◀ pr /V1/MEDIA/AUDIO/I1.SignalPresent=false

8.10.12. Analog Audio Output Volume (dB) Setting

Command and Response *#analogaudio #volume*

- ▶ SET /V1/MEDIA/AUDIO/O3.VoluedB=<level>
- ◀ pw /V1/MEDIA/AUDIO/O3.VoluedB=<level>

Parameter

The <level> parameter sets the output volume (attenuation) between -95.62 dB and 0 dB in step of -0.375 dB. The value is rounded up if necessary, to match with the step value.

Example

- ▶ SET /V1/MEDIA/AUDIO/O3.VoluedB=-15
- ◀ pw /V1/MEDIA/AUDIO/O3.VoluedB=-15.00

8.10.13. Analog Audio Output Volume Percent Setting

Command and Response

- ▶ SET /V1/MEDIA/AUDIO/O3.VolumePercent=<percent>
- ◀ pw /V1/MEDIA/AUDIO/O3.VolumePercent=<percent>

Parameters

The <percent> parameter sets the output volume (attenuation) between 100% and 0%, in step of 1%. The value is rounded up if necessary, to match with the step value.

Example

- ▶ SET /V1/MEDIA/AUDIO/O3.VolumePercent=50
- ◀ pw /V1/MEDIA/AUDIO/O3.VolumePercent=50.00

8.10.14. Setting the Balance

Command and Response *#balance*

- ▶ SET /V1/MEDIA/AUDIO/O3.Balance=<level>
- ◀ pw /V1/MEDIA/AUDIO/O3.Balance=<level>

Parameters

The <level> parameter sets the balance; -100 means left balance, 100 means right balance, step is 1. Center is 0 (default).

Example

- ▶ SET /V1/MEDIA/AUDIO/O3.Balance=0
- ◀ pw /V1/MEDIA/AUDIO/O3.Balance=0

8.10.15. Analog Audio Output Level Setting by Steps (dB)

Command and Response *#analogaudio #volume*

- ▶ CALL /V1/MEDIA/AUDIO/O3:stepVolumedB(<step>)
- ◀ m0 /V1/MEDIA/AUDIO/O3:stepVolumedB=

Parameters

The volume is increased or decreased with the given <step> value in dB.

Example

- ▶ CALL /V1/MEDIA/AUDIO/O3:stepVolumedB(-1)
- ◀ m0 /V1/MEDIA/AUDIO/O3:stepVolumedB=

The volume is decreased with 1 dB, the current volume is -1.95 dB, which means 77.84% in percent.

8.10.16. Analog Audio Output Level Setting by Steps in Percent

Command and Response

- ▶ CALL /V1/MEDIA/AUDIO/O3:stepVolumePercent(<step>)
- ◀ m0 /V1/MEDIA/AUDIO/O3:stepVolumePercent=

Parameters

The volume is increased or decreased by the given <step> value in percent.

Example

- ▶ CALL /V1/MEDIA/AUDIO/O3:stepVolumePercent(5)
- ◀ m0 /V1/MEDIA/AUDIO/O3:stepVolumePercent=

The volume is increased with 5%, the current volume is -1.52 dB, which means 82.84% in percent.

8.10.17. Analog Audio Output Balance Setting by Steps

Command and Response

- ▶ CALL /V1/MEDIA/AUDIO/O3:stepBalance(<step>)
- ◀ m0 /V1/MEDIA/AUDIO/O3:stepBalance=

Parameters

The volume is increased or decreased by the given <step> value.

Example

- ▶ CALL /V1/MEDIA/AUDIO/O3:stepBalance(-5)
- ◀ m0 /V1/MEDIA/AUDIO/O3:stepBalance=

8.11. USB Port Settings

INFO: USB port numbers may differ depending on the model. For more information, see the [Port Numbering](#) section.

8.11.1. Switching the USB Input

Command and Response *#usb*

- ▶ `CALL /V1/MEDIA/USB/XP:switch(<host>:H1)`
- ◀ `mO /V1/MEDIA/USB/XP:switch=`

Parameters

Parameter	Parameter description	Values	Value description
<host>	USB Host	0	disconnected
		U1-U4	USB-C and USB-B port number

Example

- ▶ `CALL /V1/MEDIA/USB/XP:switch(U1:H1)`
- ◀ `mO /V1/MEDIA/USB/XP:switch=`

INFO: When using the '0' value as an input, the input will be disconnected and no signal will appear on the output.

8.11.2. Querying the Connected Source

Command and Response

- ▶ `GET /V1/MEDIA/USB/XP/H1.ConnectedSource`
- ◀ `pw /V1/MEDIA/USB/XP/H1.ConnectedSource=<host>`

Parameters

Parameter	Parameter description	Values	Value description
<host>	USB Host	U1-U4	USB-C and USB-B port number

Example

- ▶ `GET /V1/MEDIA/USB/XP/H1.ConnectedSource`
- ◀ `pw /V1/MEDIA/USB/XP/H1.ConnectedSource=U4`

8.11.3. Querying the Connected Destinations

Command and Response *#autoselect*

- ▶ `GET /V1/MEDIA/USB/XP/<host>.ConnectedDestinations`
- ◀ `pr /V1/MEDIA/USB/XP/<host>.ConnectedDestinations=H1`

Parameters

Parameter	Parameter description	Values	Value description
<host>	USB Host	U1-U4	USB-C and USB-B port number

Example

- ▶ `GET /V1/MEDIA/USB/XP/U3.ConnectedDestinations`
- ◀ `pr /V1/MEDIA/USB/XP/U3.ConnectedDestinations=H1`

8.11.4. Locking the USB Port

Command and Response *#lock*

- ▶ `SET /V1/MEDIA/USB/XP/<usb_port>.Lock=<locked_state>`
- ◀ `pw /V1/MEDIA/USB/XP/<usb_port>.Lock=<locked_state>`

Parameters

Parameter	Parameter description	Values	Value description
<usb_port>	USB Port	U1-U4	USB-C and USB-B port number
		H1	USB hub
<locked_state>	Locked state	true	The port is locked
		false	The port is unlocked

Example

- ▶ `SET /V1/MEDIA/USB/XP/U2.Lock=false`
- ◀ `pw /V1/MEDIA/USB/XP/U2.Lock=false`

8.11.5. Setting the 5V Sending to the USB Peripherals

The 5V power towards the USB A-type ports can be enabled or disabled as follows:

Command and Response

- ▶ SET·/V1/MEDIA/USB/H1/<device_id>.Power5VMode=<device_pwr>
- ◀ pw·/V1/MEDIA/USB/H1/<device_id>.Power5VMode=<device_pwr>

Parameters

Parameter	Parameter description	Values	Value description
<device_id>	USB A-type port	D1-D4	Downstream port number
<device_pwr>		Auto	The host controls the 5V power sending.
		Off	Disable 5V power on USB downstream port

Example

- ▶ SET /V1/MEDIA/USB/H1/D1.Power5VMode=Auto
- ◀ pw /V1/MEDIA/USB/H1/D1.Power5VMode=Auto

8.11.6. Setting the USB Autoselect Policy

DIFFERENCE: Last detect and first detect mode is available only from FW package v1.1.0b7.

Command and Response

- ▶ SET·/V1/MEDIA/USB/AUTOSELECT/H1.Policy=<op_mode>
- ◀ pw·/V1/MEDIA/USB/AUTOSELECT/H1.Policy=<op_mode>

Parameters

Parameter	Parameter description	Values	Value description
<op_mode>	Operation mode	Off	The autoselect function is disabled.
		Last Detect	It is always the last attached input that is switched to the output automatically.
		First Detect	The first active USB input is selected.
		Follow video	Follows the video crosspoint state automatically.

Example

- ▶ SET /V1/MEDIA/USB/AUTOSELECT/H1.Policy=Follow video
- ◀ pw /V1/MEDIA/USB/AUTOSELECT/H1.Policy=Follow video

8.11.7. Setting the Followed Video Port to Autoselect

Command and Response

- ▶ SET·/V1/MEDIA/USB/AUTOSELECT/H1.VideoFollowPort=<out>
- ◀ pw·/V1/MEDIA/USB/AUTOSELECT/H1.VideoFollowPort=<out>

Example

- ▶ SET /V1/MEDIA/USB/AUTOSELECT/H1.VideoFollowPort=01
- ◀ pw /V1/MEDIA/USB/AUTOSELECT/H1.VideoFollowPort=01

8.11.8. Changing the Autoselect Included USB Ports

DIFFERENCE: This command is available only from FW package v1.1.0b7.

Command and Response

- ▶ SET·/V1/MEDIA/USB/AUTOSELECT/H1/<host>.Included=<state>
- ◀ pw·/V1/MEDIA/USB/AUTOSELECT/H1/<host>.Included=<state>

Parameters

Parameter	Parameter description	Values	Value description
<host>	USB Host	U1-U4	USB-C and USB-B port number
<state>	The chosen input is ignored in the autoselect process or not.	true	The port is included in autoselect.
		false	The autoselect function ignores that port.

Example

- ▶ SET /V1/MEDIA/USB/AUTOSELECT/H1/U1.Included=true
- ◀ pw /V1/MEDIA/USB/AUTOSELECT/H1/U1.Included=true

8.11.9. Changing the USB Port Priority

DIFFERENCE: This command is available only from FW package v1.1.0b7.

Command and Response

- ▶ SET·/V1/MEDIA/USB/AUTOSELECT/H1/<host>.Priority=<prio_num>
- ◀ pw·/V1/MEDIA/USB/AUTOSELECT/H1/<host>.Priority=<prio_num>

Parameters

Parameter	Parameter description	Values	Value description
<host>	USB Host	U1-U4	USB-C and USB-B port number
<prio_num>	Priority number from 1 to 100, equal numbers are allowed.	1-100	1: the highest priority 100: the lowest priority

Example

- ▶ SET /V1/MEDIA/USB/AUTOSELECT/H1/U1.Priority=51
- ◀ pw /V1/MEDIA/USB/AUTOSELECT/H1/U1.Priority=51

8.12. USB Port Settings - USB-C Related Commands

INFO: USB-C port numbers may differ depending on the model. For more information, see the [Port Numbering](#) section.

8.12.1. Setting the USB-C Power

Command and Response *#power*

- ▶ SET /V1/SYS/MB/USBCPOWER.PowerLimit=<power>
- ◀ pw /V1/SYS/MB/USBCPOWER.PowerLimit=<power>

Parameters

Parameter	Parameter description	Values	Value description
<power>	Power limit for the USB-C ports	0	Equal output power on the two ports (30W each)
		1	Port1 maximum, Port2 minimum (60W for U1)
		2	Port1 minimum, Port2 maximum (60W for U2)

Example

- ▶ SET /V1/SYS/MB/USBCPOWER.PowerLimit=2
- ◀ pw /V1/SYS/MB/USBCPOWER.PowerLimit=2

8.12.2. Setting the Displayport Alternate Mode Policy

Command and Response

- ▶ SET /V1/MEDIA/USB/<usb_port>.DpAltModePolicy=<dp_policy>
- ◀ pw /V1/MEDIA/USB/<usb_port>.DpAltModePolicy=<dp_policy>

Parameters

Parameter	Parameter description	Values	Value description
<usb-c_port>	USB-C port number	U1-U2	USB-C port number
<dp_policy>	The preferred video or USB data transmission	Auto	Auto: Taurus offers both operation modes described below. A BYOD device can choose between the two. Neither USB3, nor 4 lane DP Alt mode operation (4K@60) is guaranteed. BYOD devices supporting USB3.x usually choose shared mode: USB3.1 and 2 lane DP.
		Force C	Prefer video: all the four lanes are reserved for video transmission, USB 3.1 data transmission does not operate.
		Force D	Prefer USB 3.1: 2 lanes are reserved for USB 3.1, 2 lanes for video.

Example

- ▶ SET /V1/MEDIA/USB/U2.DpAltModePolicy=Auto
- ◀ pw /V1/MEDIA/USB/U2.DpAltModePolicy=Auto

ATTENTION! Changing DpAltModePolicy is recommended before connecting a computer to the input.

8.12.3. Querying the Host Alternate Mode Support

Command and Response

- ▶ GET /V1/MEDIA/USB/<usb-c_port>.HostSupportsDpAltMode
- ◀ pr /V1/MEDIA/USB/<usb-c_port>.HostSupportsDpAltMode=<altmode_support>

Parameters

Parameter	Parameter description	Value	Value description
<usb-c_port>	USB-C port number	U1-U2	USB-C port number
<altmode_support>		False	The host does not support the alternate mode.
		True	The host supports the alternate mode.

Example

- ▶ GET /V1/MEDIA/USB/U1.HostSupportsDpAltMode
- ◀ pr /V1/MEDIA/USB/U1.HostSupportsDpAltMode=true

8.12.4. Querying the Status of the Alternate Mode

Command and Response *#dpaltmode #alternatemode #displayportalternatemode*

- ▶ GET /V1/MEDIA/USB/<usb-c_port>.ActiveAltMode
- ◀ pr /V1/MEDIA/USB/<usb-c_port>.ActiveAltMode=<altmode_state>

Parameters

Parameter	Parameter description	Value	Value description
<usb-c_port>	USB-C port number	U1-U2	USB-C port number
<altmode_state>		N/A	The host is not connected
		None	DP Alt mode is not active
		DP	DP Alt mode is active.

Example

- ▶ GET /V1/MEDIA/USB/U2.ActiveAltMode
- ◀ pr /V1/MEDIA/USB/U2.ActiveAltMode=DP

8.12.5. Querying the Port Data Role

Command and Response

- ▶ GET /V1/MEDIA/USB/<usb_port>.ActivePortDataRole
- ◀ pr /V1/MEDIA/USB/<usb_port>.ActivePortDataRole=<data_role>

Parameters

Parameter	Parameter description	Values	Value description
<usb-c_port>	USB-C port number	U1-U2	USB-C port number
<data_role>		N/A	No information about the data role.
		DFP	Downstream Facing Port (usually a Host / HUB ports) The port data role is configured as USB Host. This is for building up the connection (USB data transmission operates after the data role swap)
		UFP	Upstream Facing Port (usually a device)

Example

- ▶ GET /V1/MEDIA/USB/U2.ActivePortDataRole
- ◀ pr /V1/MEDIA/USB/U2.ActivePortDataRole=UFP

8.12.6. Querying the Port Power Role

Command and Response #power

- ▶ GET /V1/MEDIA/USB/<usb_port>.ActivePortPowerRole
- ◀ pr /V1/MEDIA/USB/<usb_port>.ActivePortPowerRole=<power_role>

Parameters

Parameter	Parameter description	Values	Value description
<usb-c_port>	USB-C port number	U1-U2	USB-C port number
<power_role>		N/A	No information about the power role.
		Sink	The port is configured as a sink.
		Source	The port is configured as a source.

Example

- ▶ GET /V1/MEDIA/USB/U2.ActivePortPowerRole
- ◀ pr /V1/MEDIA/USB/U2.ActivePortPowerRole=Source

8.12.7. Setting the Port Power Role

Command and Response

- ▶ SET /V1/MEDIA/USB/<usb-c_port>.PortPowerRoleSetting=<power_role>
- ◀ pw /V1/MEDIA/USB/<usb_port>.PortPowerRoleSetting=<power_role>

Parameters

Parameter	Parameter description	Values	Value description
<usb-c_port>	USB-C port number	U1-U2	USB-C port number
<power_role>		Sink	The port is configured as a sink.
		Source	The port is configured as a source.
		Dual Role	The port is configured to be in Dual Power Role mode.

Example

- ▶ SET /V1/MEDIA/USB/U1.PortPowerRoleSetting=Dual Role
- ◀ pw /V1/MEDIA/USB/U1.PortPowerRoleSetting=Dual Role

8.13. EDID Management

8.13.1. Querying the Emulated EDIDs

Command and Response #edid

- ▶ GET /V1/EDID.EdidStatus
- ◀ pr /V1/EDID.EdidStatus=<source>:E1;<source>:E2; <source>:E3;<source>:E4

Parameters

Parameter	Parameter description	Values	Value description
<source>	Source EDID memory place	F1-F120	Factory EDIDs
		U1-U14	User EDIDs
		D1-D2	Dynamic EDIDs

Example

- ▶ GET /V1/EDID.EdidStatus
- ◀ pr /V1/EDID.EdidStatus=F89:E1;D1:E2;D1:E3;D1:E4

Emulated EDID memory for input port is listed with the EDID number that is currently emulated on the input.

8.13.2. Querying the Validity of a Dynamic EDID

Command and Response

- ▶ GET /V1/EDID/D/D1.Validity
- ◀ pr /V1/EDID/D/D1.Validity=<validity>

Parameters

If the <validity> parameter is **true**, the EDID is valid. If the parameter is **false**, the EDID is invalid.

Example

- ▶ GET /V1/EDID/D/D1.Validity
- ◀ pr /V1/EDID/D/D1.Validity=true

The 'Validity' property is true, valid EDID is stored in D1 memory place.

8.13.3. Querying the Preferred Resolution of a User EDID

Command and Response

- ▶ GET /V1/EDID/U/<user_edid>.PreferredResolution
- ◀ pr /V1/EDID/U/<user_edid>.PreferredResolution=<preferred_resolution>

Example

- ▶ GET /V1/EDID/U/U2.PreferredResolution
- ◀ pr /V1/EDID/U/U2.PreferredResolution=1920x1080p60.00Hz

■ INFO: Use the **Manufacturer** and **MonitorName** properties to query further information.

8.13.4. Emulating an EDID to an Input Port

Command and Response

- ▶ CALL /V1/EDID:switch(<source>:<destination>)
- ◀ m0 /V1/EDID:switch

Parameters

Parameter	Parameter description	Values	Value description
<source>	Source EDID memory place	F1-F120	Factory EDIDs
		U1-U14	User EDIDs
		D1-D2	Dynamic EDIDs
<destination>	The emulated EDID memory of the desired input port	U1-U14	User EDIDs

Example

- ▶ CALL /V1/EDID:switch(F49:E2)
- ◀ m0 /V1/EDID:switch

8.13.5. Emulating an EDID to All Input Ports

Command and Response

- ▶ CALL /V1/EDID:switchAll(<source>)
- ◀ m0 /V1/EDID:switchAll

Parameters

Parameter	Parameter description	Values	Value description
<source>	Source EDID memory place	F1-F148	Factory EDIDs
		U1-U100	User EDIDs
		D1-D2	Dynamic EDIDs

Example

- ▶ CALL /V1/EDID:switchAll(F47)
- ◀ m0 /V1/EDID:switchAll

8.13.6. Copying an EDID to User Memory

Command and Response

- ▶ CALL /V1/EDID:copy(<source>:<destination>)
- ◀ m0 /V1/EDID:copy

Parameters

Parameter	Parameter description	Values	Value description
<source>	Source EDID memory place	F1-F148	Factory EDIDs
		U1-U100	User EDIDs
		D1-D2	Dynamic EDIDs
<destination>	The emulated EDID memory of the desired input port	U1-U100	User EDIDs

Example

- ▶ CALL /V1/EDID:copy(F1:U2)
- ◀ m0 /V1/EDID:copy

8.13.7. Deleting an EDID from User Memory

Command and Response

- ▶ CALL /V1/EDID:delete(<user_edid>)
- ◀ m0 /V1/EDID:delete

Parameters

Parameter	Parameter description	Values	Value description
<user_edid>	The emulated EDID memory of the desired input port.	U1-U14	User EDIDs

Example

- ▶ CALL /V1/EDID:delete(U2)
- ◀ m0 /V1/EDID:delete

8.13.8. Resetting the Emulated EDIDs

Command and Response

- ▶ CALL /V1/EDID:reset()
- ◀ m0 /V1/EDID:reset

Parameters

Parameter	Parameter description	Values	Value description
<user_edid>	The emulated EDID memory of the desired input port.	U1-U14	User EDIDs

Example

- ▶ CALL /V1/EDID:reset()
- ◀ m0 /V1/EDID:reset

Calling this method switches all emulated EDIDs to a factory default one. See the table in the [Factory EDID List](#) section.

8.14. Ethernet Port Configuration

8.14.1. Setting the DHCP State

ATTENTION! When you change a network property, the new value is stored, but the **applySettings** method must always be called to apply the new settings. When two or more network parameters are changed, the **applySettings** method is enough to be called once as a final step; it will reboot the device.

Command and Response *#dhcp #network #ipaddress*

- ▶ SET /V1/MANAGEMENT/NETWORK.DhcpEnabled=<dhcp_status>
- ◀ pw /V1/MANAGEMENT/NETWORK.DhcpEnabled=<dhcp_status>

Parameters

If the <dhcp_status> parameter is **true**, the current IP address setting is DHCP, if the parameter is **false**, the current IP address is static.

Example

- ▶ SET /V1/MANAGEMENT/NETWORK.DhcpEnabled=true
- ◀ pw /V1/MANAGEMENT/NETWORK.DhcpEnabled=true
- ▶ CALL /V1/MANAGEMENT/NETWORK:applySettings()
- ◀ m0 /V1/MANAGEMENT/NETWORK:applySettings

INFO: The **applySettings** method will save and apply the new value, and it will reboot the device.

INFO: The current setting can be queried by using the [GET Command](#).

8.14.2. Changing the IP Address (Static)

Command and Response

- ▶ SET /V1/MANAGEMENT/NETWORK.StaticIpAddress=<IP_address>
- ◀ pw /V1/MANAGEMENT/NETWORK.StaticIpAddress=<IP_address>

Example

- ▶ SET /V1/MANAGEMENT/NETWORK.StaticIpAddress=192.168.0.85
- ◀ pw /V1/MANAGEMENT/NETWORK.StaticIpAddress=192.168.0.85
- ▶ CALL /V1/MANAGEMENT/NETWORK:applySettings()
- ◀ m0 /V1/MANAGEMENT/NETWORK:applySettings

INFO: The **applySettings** method will save and apply the new value and it will reboot the device.

INFO: The current setting can be queried by using the [GET Command](#).

8.14.3. Changing the Subnet Mask (Static)

Command and Response *#ipaddress*

- ▶ SET /V1/MANAGEMENT/NETWORK.StaticNetworkMask=<netmask>
- ◀ pw /V1/MANAGEMENT/NETWORK.StaticNetworkMask=<netmask>

Example

- ▶ SET /V1/MANAGEMENT/NETWORK.StaticNetworkMask=255.255.255.0
- ◀ pw /V1/MANAGEMENT/NETWORK.StaticNetworkMask=255.255.255.0
- ▶ CALL /V1/MANAGEMENT/NETWORK:applySettings()
- ◀ m0 /V1/MANAGEMENT/NETWORK:applySettings

INFO: The **applySettings** method will save and apply the new value and it will reboot the device.

INFO: The current setting can be queried by using the [GET Command](#).

8.14.4. Changing the Gateway Address (Static)

Command and Response

- ▶ SET /V1/MANAGEMENT/NETWORK.StaticGatewayAddress=<gw_address>
- ◀ pw /V1/MANAGEMENT/NETWORK.StaticGatewayAddress=<gw_address>

Example

- ▶ SET /V1/MANAGEMENT/NETWORK.StaticGatewayAddress=192.168.0.5
- ◀ pw /V1/MANAGEMENT/NETWORK.StaticGatewayAddress=192.168.0.5
- ▶ CALL /V1/MANAGEMENT/NETWORK:applySettings()
- ◀ m0 /V1/MANAGEMENT/NETWORK:applySettings

INFO: The **applySettings** method will save and apply the new value, and it will reboot the device.

INFO: The current setting can be queried by using the [GET Command](#).

8.14.5. Applying the Network Settings

Command and Response

- ▶ CALL /V1/MANAGEMENT/NETWORK:applySettings()
- ◀ m0 /V1/MANAGEMENT/NETWORK:applySettings

Example

- ▶ CALL /V1/MANAGEMENT/NETWORK:applySettings()
- ◀ m0 /V1/MANAGEMENT/NETWORK:applySettings

All network settings that were changed are applied and network interface restarts.

8.14.6. Setting the Host Name

The host name is a property that can be used instead of the IP address when connecting to the device. It is also suitable for finding the device in the Device Discovery window of the LDC, see more details in the [Add New Favorite Device](#) section. If the IP address of the device is changing, the host name can be used as a fixed property.

Restarting HTTP(S) Services is required after the host name changed. A new certificate is generated after modifying the host name.

Command and Response

- ▶ SET /V1/MANAGEMENT/NETWORK.HostName=<unique_name>
- ◀ pw /V1/MANAGEMENT/NETWORK.HostName=<unique_name>

Parameters

The <unique_name> can be 1-64 character(s) long, and the following are allowed for naming: the elements of the English alphabet and numbers. Hyphen (-) is also accepted, except as last character.

DIFFERENCE: Prior to firmware version v2.2.3b4, a bug may occur if the first character of the host name is a number, which causes the device to revert to factory default settings upon reboot. From firmware version v2.2.3b4, this is fixed.

Example

- ▶ SET /V1/MANAGEMENT/NETWORK.HostName=room-switcher
- ◀ pw /V1/MANAGEMENT/NETWORK.HostName=room-switcher

8.15. Network Security

8.15.1. Enabling/Disabling the Ethernet Port

Command and Response

- ▶ SET /V1/MEDIA/ETHERNET/<ethernet_port>.Enabled=<status>
- ◀ pw /V1/MEDIA/ETHERNET/<ethernet_port>.Enabled=<status>

Parameters

Parameter	Parameter description	Values	Value description
<ethernet_port>	Ethernet port number	P1-P5	
		true	The port is enabled.
		false	The port is disabled.

Example

- ▶ SET /V1/MEDIA/ETHERNET/P4.Enabled=true
- ◀ pw /V1/MEDIA/ETHERNET/P4.Enabled=true

DIFFERENCE: From firmware version v2.9.0, disabling the Ethernet port will cause the USB connection to restart on the corresponding USB-C port in HW versions below v5.0.

8.15.2. Querying the Service Port Number

DIFFERENCE: This command is available from v1.2.0 firmware package.

Command and Response

- ▶ GET /V1/MANAGEMENT/NETWORK/SERVICES/<port>.Port
- ◀ pr /V1/MANAGEMENT/NETWORK/SERVICES/<port>.Port=<port_num>

Parameters

Parameter	Parameter description	Parameter values
<port>	Port type	HTTP HTTPS LW3 UART1 UART2
<port_num>	Port number	80 443 6107 8001 8002

Example

- ▶ GET /V1/MANAGEMENT/NETWORK/SERVICES/HTTP.Port
- ◀ pr /V1/MANAGEMENT/NETWORK/SERVICES/HTTP.Port=80

8.15.3. Enabling/Disabling the Service Port

DIFFERENCE: This command is available from v1.2.0 firmware package.

Command and Response #http #https

- ▶ SET /V1/MANAGEMENT/NETWORK/SERVICES/<port>.Enabled=<status>
- ◀ pw /V1/MANAGEMENT/NETWORK/SERVICES/<port>.Enabled=<status>

Parameters

Parameter	Parameter description	Values	Value description
<port>	Port type	HTTP HTTPS	
<status>		true	The port is enabled.
		false	The port is disabled.

Example

- ▶ SET /V1/MANAGEMENT/NETWORK/SERVICES/HTTP.Enabled=true
- ◀ pw /V1/MANAGEMENT/NETWORK/SERVICES/HTTP.Enabled=true

8.15.4. Querying the Username for Authentication

DIFFERENCE: This command is available from v1.2.0 firmware package.

INFO: UCX series deal with one user for authentication and the username (admin) can not be changed.

Command and Response

- ▶ GET /V1/MANAGEMENT/NETWORK/AUTH/USER1.Name
- ◀ pr /V1/MANAGEMENT/NETWORK/AUTH/USER1.Name=admin

Example

- ▶ GET /V1/MANAGEMENT/NETWORK/AUTH/USER1.Name
- ◀ pr /V1/MANAGEMENT/NETWORK/AUTH/USER1.Name=admin

8.15.5. Setting a Password for Authentication

DIFFERENCE: This command is available from v1.2.0 to v2.1.0 firmware package. From firmware version v2.2.0, password setting is only available through REST API.

INFO: Due to security reasons, the password is not stored in any property, so it cannot be queried. No password is set by default, setting a password before authorizing the authentication is necessary.

Command and Response *#password*

- ▶ CALL /V1/MANAGEMENT/NETWORK/AUTH/USER1:setPassword(<password>)
- ◀ mO /V1/MANAGEMENT/NETWORK/AUTH/USER1:setPassword=

Parameters

Parameter	Parameter description	Value description
<password>	User defined password for authentication.	max. character length: 100 accepted characters: a-z, A-Z, 0-9

Example

- ▶ CALL /V1/MANAGEMENT/NETWORK/AUTH/USER1:setPassword(password)
- ◀ mO /V1/MANAGEMENT/NETWORK/AUTH/USER1:setPassword=

8.15.6. Enabling the Authentication

DIFFERENCE: This command is available from v1.2.0 firmware package.

INFO: Set the password before enabling the authentication, because no password is set by default.

Command and Response

- ▶ SET /V1/MANAGEMENT/NETWORK/SERVICES/<port>.AuthenticationEnabled=<status>
- ◀ pw /V1/MANAGEMENT/NETWORK/SERVICES/<port>.AuthenticationEnabled=<status>
- ▶ CALL /V1/MANAGEMENT/NETWORK/SERVICES/HTTP:restart()
- ◀ mO /V1/MANAGEMENT/NETWORK/SERVICES/HTTP:restart=

Parameters

Parameter	Parameter description	Values	Value description
<port>	Port type	HTTP HTTPS	
<status>		true	The authentication is enabled.
		false	The authentication is disabled.

Example

- ▶ SET /V1/MANAGEMENT/NETWORK/SERVICES/HTTP.AuthenticationEnabled=true
 - ◀ pw /V1/MANAGEMENT/NETWORK/SERVICES/HTTP.AuthenticationEnabled=true
 - ▶ CALL /V1/MANAGEMENT/NETWORK/SERVICES/HTTP:restart()
 - ◀ mO /V1/MANAGEMENT/NETWORK/SERVICES/HTTP:restart=
- INFO:** Restart HTTP(S) Services is required after the authentication settings changed.

8.15.7. Restarting the Network Services

DIFFERENCE: This command is available from v1.2.0 firmware package.

Command and Response *#http #https*

- ▶ CALL /V1/MANAGEMENT/NETWORK/SERVICES/<port>:restart()
- ◀ mO /V1/MANAGEMENT/NETWORK/SERVICES/<port>:restart=

Parameters

Parameter	Parameter description	Parameter values
<port>	Port type	HTTP HTTPS

Example

- ▶ CALL /V1/MANAGEMENT/NETWORK/SERVICES/HTTP:restart()
- ◀ mO /V1/MANAGEMENT/NETWORK/SERVICES/HTTP:restart=

8.16. Advanced Ethernet Security

8.16.1. Setting the VLAN Preset

DIFFERENCE: This command is available from firmware package v1.6.0.

Command and Response

- ▶ SET /V1/MEDIA/ETHERNET.VlanPreset=<vlan_preset>
- ◀ pw /V1/MEDIA/ETHERNET.VlanPreset=<vlan_preset>

Parameters

Parameter	Parameter description	Values	Value description
<vlan_preset>	VLAN preset mode	Transparent	The same open network is used by the Taurus and the BYOD devices.
		SeparateBYOD	The BYOD devices use a network that is separated from the main line.
		Dedicated	Every BYOD device uses a separate network.

Example

- ▶ SET /V1/MEDIA/ETHERNET.VlanPreset=Transparent
- ◀ pw /V1/MEDIA/ETHERNET.VlanPreset=Transparent

8.16.2. Setting the VLAN Membership

DIFFERENCE: This command is available from firmware package v2.9.0.

ATTENTION! Changing the VLAN membership of the Control Ethernet port will cause loss of the connection to the device. Please make sure you are changing the correct settings.

With this command the Ethernet ports can be arranged into separate networks in any setup desired.

Command and Response

- ▶ SET /V1/MEDIA/ETHERNET/<port_number>.VlanMembership=<vlan_membership>
- ◀ pw /V1/MEDIA/ETHERNET/<port_number>.VlanMembership=<vlan_membership>

Parameters

Parameter	Parameter description	Values	Value description
<vlan_membership>	VLAN membership number	1-8	The ports with the same membership number are part of the same network.

Example

- ▶ SET /V1/MEDIA/ETHERNET/P3.VlanMembership=3
- ◀ pw /V1/MEDIA/ETHERNET/P3.VlanMembership=3

8.17. Serial Port Configuration

DIFFERENCE: Serial port-related commands are available only from FW package v1.2.0.

8.17.1. BAUD Rate Setting

Command and Response #rs-232 #rs232

- ▶ SET /V1/MEDIA/SERIAL/<serial_port>.Baudrate=<baudrate>
- ◀ pw /V1/MEDIA/SERIAL/<serial_port>.Baudrate=<baudrate>

Parameters

Identifier	Parameter description	Parameter values
<serial_port>	Serial port number	P1-P2
<baudrate>	Baud rate value	9600 19200 38400 57600 115200

Example

- ▶ SET /V1/MEDIA/SERIAL/P1.Baudrate=19200
- ◀ pw /V1/MEDIA/SERIAL/P1.Baudrate=19200

8.17.2. Stop Bits Setting

Command and Response #rs-232 #rs232

- ▶ SET /V1/MEDIA/SERIAL/<serial_port>.StopBits=<stopbits>
- ◀ pw /V1/MEDIA/SERIAL/<serial_port>.StopBits=<stopbits>

Parameters

Identifier	Parameter description	Parameter values
<serial_port>	Serial port number	P1-P2*
<stopbits>	Stop bit value	1 2

*The UCX-2x1-HC30 and UCX-2x1-HC40 models have one serial port (P1).

Example

- ▶ SET /V1/MEDIA/SERIAL/P1.StopBits=1
- ◀ pw /V1/MEDIA/SERIAL/P1.StopBits=1

8.17.3. Querying the Data Bits

Command and Response *#rs-232 #rs232*

- ▶ GET·/V1/MEDIA/SERIAL/<serial_port>.DataBits
- ◀ pr·/V1/MEDIA/SERIAL/<serial_port>.DataBits=<databits>

Parameters

Identifier	Parameter description	Parameter values
<serial_port>	Serial port number	P1-P2
<databits>	DataBits value	8 9

Example

- ▶ GET /V1/MEDIA/SERIAL/P1.DataBits
- ◀ pr /V1/MEDIA/SERIAL/P1.DataBits=8

8.17.4. Parity Setting

Command and Response *#rs-232 #rs232*

- ▶ SET·/V1/MEDIA/SERIAL/<serial_port>.Parity=<parity>
- ◀ pw·/V1/MEDIA/SERIAL/<serial_port>.Parity=<parity>

Parameters

Identifier	Parameter description	Parameter values
<serial_port>	Serial port number	P1-P2
<parity>	Parity value	None Odd Even

Example

- ▶ SET /V1/MEDIA/SERIAL/P1.Parity=None
- ◀ pw /V1/MEDIA/SERIAL/P1.Parity=None

8.18. Sending a Message via RS-232

ATTENTION! Serial message sending is implemented only via Lightware REST API. This function is not available with LW3 protocol command. For more details, see [Serial Port Messaging](#).

8.19. GPIO Port Configuration

DIFFERENCE: GPIO-related commands are available only from FW package v1.1.0b7.

8.19.1. Querying the Direction of a GPIO Pin

Command and Response *#gpio*

- ▶ GET·/V1/MEDIA/GPIO/<port>.Direction
- ◀ pw·/V1/MEDIA/GPIO/<port>.Direction(<dir>)

Parameters

Parameter	Parameter description	Value	Value description
<dir>	The direction of the GPIO pin.	Input	input
		Output	output

Example

- ▶ GET /V1/MEDIA/GPIO/P1.Direction
- ◀ pw /V1/MEDIA/GPIO/P1.Direction=Input

8.19.2. Setting the Direction of a GPIO Pin

Command and Response

- ▶ SET·/V1/MEDIA/GPIO/<port>.Direction(<dir>)
- ◀ pw·/V1/MEDIA/GPIO/<port>.Direction(<dir>)

Parameters

See the previous section.

Example

- ▶ SET /V1/MEDIA/GPIO/P1.Direction=Input
- ◀ pw /V1/MEDIA/GPIO/P1.Direction=Input

8.19.3. Querying the Output Level of a GPIO Pin

Command and Response

- ▶ GET·/V1/MEDIA/GPIO/<port>.Output
- ◀ pw·/V1/MEDIA/GPIO/<port>.Output(<value>)

Parameters

Parameter	Parameter description	Value	Value description
<value>	The output value of the GPIO pin.	High	high level
		Low	low level

Example

- ▶ GET /V1/MEDIA/GPIO/P1.Output
- ◀ pw /V1/MEDIA/GPIO/P1.Output=Low

8.19.4. Setting the Output Level of a GPIO Pin

Command and Response

- ▶ SET /V1/MEDIA/GPIO/<port>.Output(<value>)
- ◀ pw /V1/MEDIA/GPIO/<port>.Output(<value>)

Parameters

See the previous section.

Example

- ▶ SET /V1/MEDIA/GPIO/P1.Output=High
- ◀ pw /V1/MEDIA/GPIO/P1.Output=High

8.19.5. Setting the Output Level for a Specified Time

Command and Response

- ▶ CALL /V1/MEDIA/GPIO/<port>:interval(<value>;<time>)
- ◀ mO /V1/MEDIA/GPIO/<port>:interval=

Parameters

Parameter	Parameter description	Value	Value description
<value>	The output value of the GPIO pin.	High	high level
		Low	low level
<time>	Duration of the desired value in seconds.	1-120	second(s)

Example

- ▶ CALL /V1/MEDIA/GPIO/P1:interval(Low;1)
- ◀ mO /V1/MEDIA/GPIO/P1:interval=

8.19.6. Toggling the Level of a GPIO Pin

The output level can be changed from high to low and from low to high by the command below.

Command and Response

- ▶ CALL /V1/MEDIA/GPIO/<port>:toggle()
- ◀ mO /V1/MEDIA/GPIO/<port>:toggle

Example

- ▶ CALL /V1/MEDIA/GPIO/P1:toggle()
- ◀ mO /V1/MEDIA/GPIO/P1:toggle

8.20. OCS Port Configuration

DIFFERENCE: Occupancy sensor-related commands are available only from FW package v1.1.0b7.

8.20.1. Querying the Input Level of an OCS Pin

Command and Response #ocs

- ▶ GET /V1/MEDIA/OCS/P1.InputLevel
- ◀ pr /V1/MEDIA/OCS/P1.InputLevel=<value>

Parameters

Parameter	Parameter description	Value	Value description
<value>	The input value of the OCS pin.	High	high level
		Low	low level

Example

- ▶ GET /V1/MEDIA/OCS/P1.InputLevel
- ◀ pr /V1/MEDIA/OCS/P1.InputLevel=Low

8.20.2. Setting the Sensor Type

Command and Response

- ▶ SET /V1/MEDIA/OCS/P1.SensorType=<sensor_type>
- ◀ pw /V1/MEDIA/OCS/P1.SensorType=<sensor_type>

Parameters

Parameter	Parameter description	Value	Value description
<sensor_type>	It defines whether the low or high input level means the occupancy.	Active low	Occupancy status is 'Occupied' when the input level is low.
		Active high	Occupancy status is 'Occupied' when the input level is high (default value).

Example

- ▶ SET /V1/MEDIA/OCS/P1.SensorType=Active low
- ◀ pw /V1/MEDIA/OCS/P1.SensorType=Active low

8.20.3. Querying the Reported OCS State

Command and Response

- ▶ GET /V1/MEDIA/OCS/P1.State
- ◀ pr /V1/MEDIA/OCS/P1.State=<status>

Parameters

Parameter	Parameter description	Value	Value description
<status>	It reports the occupancy state of the room depending on the sensor type.	Free	When the SensorType=Active high and the Inputlevel=Low or when SensorType=Active low and Inputlevel=High
		Occupied	When the SensorType=Active high and the Inputlevel=High or when SensorType=Active low and Inputlevel=Low

Example

- ▶ GET /V1/MEDIA/OCS/P1.State
- ◀ pr /V1/MEDIA/OCS/P1.State=Free

8.21. LW3 Commands - Quick Summary

System Commands

Setting the Device Label

- ▶ SET·/V1/MANAGEMENT/LABEL.DeviceLabel=<custom_name>

Resetting the Device

- ▶ CALL·/V1/SYS:restart()

Restoring the Factory Default Settings

- ▶ CALL·/V1/SYS:factoryDefaults()

Querying the Firmware Package Version

- ▶ GET·/V1/MANAGEMENT/UID/PACKAGE.Version

Control Lock

- ▶ SET·/V1/MANAGEMENT/UI.ControlLock=<lock_status>

Setting the Current Time

- ▶ CALL·/V1/MANAGEMENT/DATETIME:setTime(<current_time>)

Identifying the Device

- ▶ CALL /V1/MANAGEMENT/UI:identifyMe()

Toggling the Dark Mode Setting

- ▶ SET·/V1/MANAGEMENT/UI/DARKMODE.Enable=<mode_state>

Setting the Delay of the Dark Mode Setting

- ▶ SET·/V1/MANAGEMENT/UI/DARKMODE.Delay=<delay_time>

Video Port Settings - General

Switching Video Input

- ▶ CALL·/V1/MEDIA/VIDEO/XP:switch(<in>:<out>)

Switching an Input to All Outputs

- ▶ CALL·/V1/MEDIA/VIDEO/XP:switchAll(<input>)

Locking the Video Port

- ▶ SET·/V1/MEDIA/VIDEO/XP/<port>.Lock=<locked_state>

Muting the Video Port

- ▶ SET·/V1/MEDIA/VIDEO/XP/<port>.Mute=<muted_state>

Setting the Autoselect Policy

- ▶ SET·/V1/MEDIA/VIDEO/AUTOSELECT/<out>.Policy=<autoselect_mode>

Changing the Autoselect Included Input Ports

- ▶ SET·/V1/MEDIA/VIDEO/AUTOSELECT/<out>/<in>.Included=<state>

Changing the Input Port Priority

- ▶ SET·/V1/MEDIA/VIDEO/AUTOSELECT/<out>/<in>.Priority=<prio_num>

Querying the Connected Source

- ▶ GET·/V1/MEDIA/VIDEO/XP/<out>.ConnectedSource

Querying the Input Switching Capability

- ▶ GET·/V1/MEDIA/VIDEO/XP/<out>/SWITCHABLE.<in>

Querying the Connected Destinations

- ▶ GET·/V1/MEDIA/VIDEO/XP/<n>.ConnectedDestinations

Querying the Video Signal Presence

- ▶ GET·/V1/MEDIA/VIDEO/<port>.SignalPresent

HDCP Setting (Input Port)

- ▶ SET·/V1/MEDIA/VIDEO/<in>/HDCP.AllowedHdcpVersion=<allowed_hdcp>

HdcpMode

- ▶ SET·/V1/MEDIA/VIDEO/<out>.HdcpMode=<hdcp_mode>

OutputSignalType

- ▶ SET·/V1/MEDIA/VIDEO/<out>.OutputSignalType=<signal_type>

EmbeddedAudioPresent

- ▶ GET·/V1/MEDIA/VIDEO/<port>.EmbeddedAudioPresent

EmbeddedAudioMute

- ▶ SET·/V1/MEDIA/VIDEO/<port>.EmbeddedAudioMute=<mute_state>

Output5VMode

- ▶ SET·/V1/MEDIA/VIDEO/<out>.Output5VMode=<5V_pwr>

HDCP Capability (Output Port)

- ▶ GET·/V1/MEDIA/VIDEO/<out>/HDCP/SinkMaxHdcpVersion=<hdcp_ver>

HDCP Setting (Output Port)

- ▶ GET·/V1/MEDIA/VIDEO/<out>/HDCP.AllowedHdcpVersion=<allowed_hdcp>

Welcome Screen Settings

Displaying the Welcome Screen Image

- ▶ SET·/V1/MEDIA/VIDEO/I5/WELCOMESCREEN.ImageEnabled=<image_state>

Displaying the Welcome Screen Text

- ▶ SET·/V1/MEDIA/VIDEO/I5/WELCOMESCREEN.MessageEnabled=<text_state>

Setting the Welcome Screen Text

- ▶ SET·/V1/MEDIA/VIDEO/I5/WELCOMESCREEN.MessageText=<text>

Resetting the Welcome Screen Image

- ▶ CALL·/V1/MEDIA/VIDEO/I5/WELCOMESCREEN.resetImage()

Video Port Settings - USB-C Related Commands**Restarting the Link Training**

- ▶ CALL·/V1/MEDIA/VIDEO/<in>/DP.restartLinkTraining()

CEC Command Sending**Simple CEC Code Sending**

- ▶ CALL /V1/MEDIA/VIDEO/<out>/CEC:send(<command>)

Remote Control Code Sending

- ▶ CALL·/V1/MEDIA/VIDEO/<port>/CEC:sendUserControlClick(<command>)

Audio Port Settings**Switching the Audio Input**

- ▶ CALL·/V1/MEDIA/AUDIO/XP:switch(<audio_in>:O3)

Querying the Connected Source

- ▶ GET·/V1/MEDIA/AUDIO/XP/O3.ConnectedSource

Querying the Connected Destinations

- ▶ GET·/V1/MEDIA/AUDIO/XP/<audio_in>.ConnectedDestinations

Setting the Autoselect Operation Mode

- ▶ SET·/V1/MEDIA/AUDIO/AUTOSELECT/O3.Policy=<op_mode>

Setting the Followed Video Port to Autoselect

- ▶ SET·/V1/MEDIA/AUDIO/AUTOSELECT/O3.VideoFollowPort=<out>

Enabling/Disabling the Dante USB Sound Card

- ▶ SET /V1/SYS/BD_DANTE_ADDON.Enabled=<status>

Setting the Audio Device Type for the Dante Input

- ▶ SET /V1/MEDIA/AUDIO/DANTE_IN.AudioDeviceType=<device_type>

Locking the Audio Port

- ▶ SET·/V1/MEDIA/AUDIO/XP/<audio_port>.Lock=<locked_state>

Muting the Audio Port 1.

- ▶ SET·/V1/MEDIA/AUDIO/XP/<audio_port>.Mute=<muted_state>

Muting the Audio Port 2.

- ▶ SET·/V1/MEDIA/AUDIO/O3.Mute=<muted_state>

Querying the Audio Signal Presence

- ▶ GET·/V1/MEDIA/AUDIO/<audio_port>.SignalPresent

Analog Audio Output Volume (dB) Setting

- ▶ SET·/V1/MEDIA/AUDIO/O3.VolumedB=<level>

Analog Audio Output Volume Percent Setting

- ▶ SET·/V1/MEDIA/AUDIO/O3.VolumePercent=<percent>

Setting the Balance

- ▶ SET·/V1/MEDIA/AUDIO/O3.Balance=<level>

Analog Audio Output Level Setting by Steps (dB)

- ▶ CALL·/V1/MEDIA/AUDIO/O3:stepVolumedB(<step>)

Analog Audio Output Level Setting by Steps in Percent

- ▶ CALL·/V1/MEDIA/AUDIO/O3:stepVolumePercent(<step>)

Analog Audio Output Balance Setting by Steps

- ▶ CALL·/V1/MEDIA/AUDIO/O3:stepBalance(<step>)

USB Port Settings**Switching the USB Input**

- ▶ CALL·/V1/MEDIA/USB/XP:switch(<host>:H1)

Querying the Connected Source

- ▶ GET·/V1/MEDIA/USB/XP/H1.ConnectedSource

Querying the Connected Destinations

- ▶ GET·/V1/MEDIA/USB/XP/<host>.ConnectedDestinations

Locking the USB Port

- ▶ SET·/V1/MEDIA/USB/XP/<usb_port>.Lock=<locked_state>

Setting the 5V Sending to the USB Peripherals

- ▶ SET·/V1/MEDIA/USB/H1/<device_id>.Power5VMode=<device_pwr>

Setting the USB Autoselect Policy

- ▶ SET·/V1/MEDIA/USB/AUTOSELECT/H1.Policy=<op_mode>

Setting the Followed Video Port to Autoselect

- ▶ SET·/V1/MEDIA/USB/AUTOSELECT/H1.VideoFollowPort=<out>

Changing the Autoselect Included USB Ports

- ▶ SET·/V1/MEDIA/USB/AUTOSELECT/H1/<host>.Included=<state>

Changing the USB Port Priority

- ▶ SET·/V1/MEDIA/USB/AUTOSELECT/H1/<host>.Priority=<prio_num>

USB Port Settings - USB-C Related Commands**Setting the USB-C Power**

- ▶ SET·/V1/SYS/MB/USBCPOWER.PowerLimit=<power>

Setting the Displayport Alternate Mode Policy

- ▶ SET·/V1/MEDIA/USB/<usb_port>.DpAltModePolicy=<dp_policy>

Querying the Host Alternate Mode Support

- ▶ GET·/V1/MEDIA/USB/<usb-c_port>.HostSupportsDpAltMode

Querying the Status of the Alternate Mode

- ▶ GET·/V1/MEDIA/USB/<usb-c_port>.ActiveAltMode

Querying the Port Data Role

- ▶ GET·/V1/MEDIA/USB/<usb_port>.ActivePortDataRole

Querying the Port Power Role

- ▶ GET·/V1/MEDIA/USB/<usb_port>.ActivePortPowerRole

Setting the Port Power Role

- ▶ SET·/V1/MEDIA/USB/<usb-c_port>.PortPowerRoleSetting=<power_role>

EDID Management**Querying the Emulated EDIDs**

- ▶ GET·/V1/EDID.EdidStatus

Querying the Validity of a Dynamic EDID

- ▶ GET·/V1/EDID/D/D1.Validity

Querying the Preferred Resolution of a User EDID

- ▶ GET·/V1/EDID/U/<user_edid>.PreferredResolution

Emulating an EDID to an Input Port

- ▶ CALL·/V1/EDID:switch(<source>:<destination>)

Emulating an EDID to All Input Ports

- ▶ CALL·/V1/EDID:switchAll(<source>)

Copying an EDID to User Memory

- ▶ CALL·/V1/EDID:copy(<source>:<destination>)

Deleting an EDID from User Memory

- ▶ CALL·/V1/EDID:delete(<user_edid>)

Resetting the Emulated EDIDs

- ▶ CALL·/V1/EDID:reset()

Ethernet Port Configuration**Setting the DHCP State**

- ▶ SET·/V1/MANAGEMENT/NETWORK.DhcpEnabled=<dhcp_status>

Changing the IP Address (Static)

- ▶ SET·/V1/MANAGEMENT/NETWORK.StaticIpAddress=<IP_address>

Changing the Subnet Mask (Static)

- ▶ SET·/V1/MANAGEMENT/NETWORK.StaticNetworkMask=<netmask>

Changing the Gateway Address (Static)

- ▶ SET·/V1/MANAGEMENT/NETWORK.StaticGatewayAddress=<gw_address>

Applying the Network Settings

- ▶ CALL·/V1/MANAGEMENT/NETWORK:applySettings()

Setting the Host Name

- ▶ SET·/V1/MANAGEMENT/NETWORK.HostName=<unique_name>

Network Security**Enabling/Disabling the Ethernet Port**

- ▶ SET·/V1/MEDIA/ETHERNET/<ethernet_port>.Enabled=<status>

Querying the Service Port Number

- ▶ GET·/V1/MANAGEMENT/NETWORK/SERVICES/<port>.Port

Enabling/Disabling the Service Port

- ▶ SET·/V1/MANAGEMENT/NETWORK/SERVICES/<port>.Enabled=<status>

Querying the Username for Authentication

- ▶ GET·/V1/MANAGEMENT/NETWORK/AUTH/USER1.Name

Setting a Password for Authentication

- ▶ CALL·/V1/MANAGEMENT/NETWORK/AUTH/USER1:setPassword(<password>)

Enabling the Authentication

- ▶ SET·/V1/MANAGEMENT/NETWORK/SERVICES/<port>.AuthenticationEnabled=<status>

- ▶ CALL /V1/MANAGEMENT/NETWORK/SERVICES/HTTP:restart()

Restarting the Network Services

- ▶ CALL /V1/MANAGEMENT/NETWORK/SERVICES/<port>:restart()

Advanced Ethernet Security

Setting the VLAN Preset

- ▶ SET /V1/MEDIA/ETHERNET.VlanPreset=<vlan_preset>

Setting the VLAN Membership

- ▶ SET /V1/MEDIA/ETHERNET/<port_number>.VlanMembership=<vlan_membership>

Serial Port Configuration

BAUD Rate Setting

- ▶ SET /V1/MEDIA/SERIAL/<serial_port>.Baudrate=<baudrate>

Stop Bits Setting

- ▶ SET /V1/MEDIA/SERIAL/<serial_port>.StopBits=<stopbits>

Querying the Data Bits

- ▶ GET /V1/MEDIA/SERIAL/<serial_port>.DataBits

Parity Setting

- ▶ SET /V1/MEDIA/SERIAL/<serial_port>.Parity=<parity>

Sending a Message via RS-232

GPIO Port Configuration

Querying the Direction of a GPIO Pin

- ▶ GET /V1/MEDIA/GPIO/<port>.Direction

Setting the Direction of a GPIO Pin

- ▶ SET /V1/MEDIA/GPIO/<port>.Direction(<dir>)

Querying the Output Level of a GPIO Pin

- ▶ GET /V1/MEDIA/GPIO/<port>.Output

Setting the Output Level of a GPIO Pin

- ▶ SET /V1/MEDIA/GPIO/<port>.Output(<value>)

Setting the Output Level for a Specified Time

- ▶ CALL /V1/MEDIA/GPIO/<port>.interval(<value>;<time>)

Toggling the Level of a GPIO Pin

- ▶ CALL /V1/MEDIA/GPIO/<port>.toggle()

OCS Port Configuration

Querying the Input Level of an OCS Pin

- ▶ GET /V1/MEDIA/OCS/P1.InputLevel

Setting the Sensor Type

- ▶ SET /V1/MEDIA/OCS/P1.SensorType=<sensor_type>

Querying the Reported OCS State

- ▶ GET /V1/MEDIA/OCS/P1.State

9

Firmware Update

This chapter is meant to help customers perform firmware updates on our products by giving a few tips on how to start and by explaining the features of the Lightware Device Updater v2 (LDU2) software. The latest software and firmware pack can be downloaded from www.lightware.com.

- ▶ INTRODUCTION
- ▶ PREPARATION
- ▶ RUNNING THE SOFTWARE
- ▶ UPDATING VIA GUI
- ▶ COMMAND LINE INTERFACE (CLI)
- ▶ CLI COMMANDS
- ▶ UPDATING VIA REST API
- ▶ IF THE UPDATE IS NOT SUCCESSFUL

ATTENTION! While the firmware is being updated, the normal operation mode is suspended, as the transmitter is switched to bootload mode. Signal processing is not performed. Do not interrupt the firmware update. If any problem occurs, reboot the device and restart the process.

9.1. Introduction

Lightware Device Updater v2 (LDU2) software is the second generation of the LFP-based (Lightware Firmware Package) firmware update process.



LDU2

9.2. Preparation

Most Lightware devices can be controlled over several interfaces (e.g. Ethernet, USB, RS-232). But the firmware can be updated usually over one dedicated interface, which is the Ethernet in most cases.

If you want to update the firmware of one or more devices, you need the following:

- **LFP2 file**,
- **LDU2 software** installed on your PC or Mac.

Both can be downloaded from www.lightware.com/downloads.

Optionally, you can download the **release notes** file in HTML format.

9.2.1. About the Firmware Package (LFP2 File)

All the necessary tools and binary files are packed into the LFP2 package file. You only need this file to do the update on your device.

- This allows the use of the same LFP2 package for different devices.
- The package contains all the necessary components, binary, and other files.
- The release notes is included in the LFP2 file, which is displayed in the window where you select the firmware package file in LDU2.

INFO: The size of the LFP2 file is more than 200 MB due to the components of the package. That is not a fault: Taurus runs embedded Linux inside that is necessary for the complex functions and features of the device.

9.2.2. LDU2 Installation

ATTENTION! Minimum system requirement: 2 GB RAM. The minimum display resolution is 1600x900.

INFO: The Windows and the Mac applications have the same look and functionality.

Download the software from www.lightware.com/downloads.

Installation in case of Windows OS

Run the installer. If the User Account Control displays a pop-up message, click **Yes**.



Installation Modes

Normal install	Snapshot install
Available for Windows, MacOS and Linux	Available for Windows
The installer can update only this instance	Cannot be updated
One updateable instance may exist for all users	Many different versions can be installed for all users

ATTENTION! Using the default Normal install is highly recommended.

INFO: If you have a previously installed version, you will be prompted to remove the old version before installing the new one.

Installation in case of macOS

Mount the DMG file by double clicking on it, and drag the LDU2 icon over the Applications icon to copy the program into the Applications folder. If you want to copy LDU2 into another location, just drag the icon over the desired folder.

ATTENTION! Please check the firewall settings on the macOS device. LDC needs to be added to the exceptions of the blocked software for the proper operation.

INFO: This type of installer is equal to the **Normal install** of Windows.



Installation in case of Linux

Step 1. Download the **archive file** (tar.gz) from www.lightware.com and unpack it to a temp folder.

Step 2. Run the **install_ldu2.sh** file in the temp folder. The script will install LDU2 into the following folder: HOME/.local/share/lightware/ldu2.

Step 3. The folder above will contain this file: **LightwareDeviceUpdaterV2.sh**, which can be used to start LDU2.

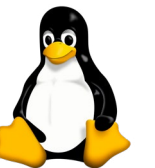

9.3. Running the Software

You have two options:

- **Starting the LDU2** by double-clicking on the shortcut/program file, or
- Double-clicking on an **LFP2 file**.

LDU2 Auto-Update

At startup, the software checks if a newer version is available on the web.

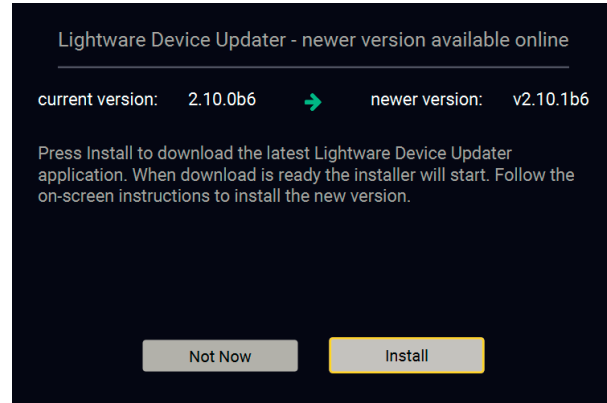

Main Screen

When the software is started by the shortcut, the device discovery screen appears. Press the **Discover devices** button to start finding the Lightware devices:

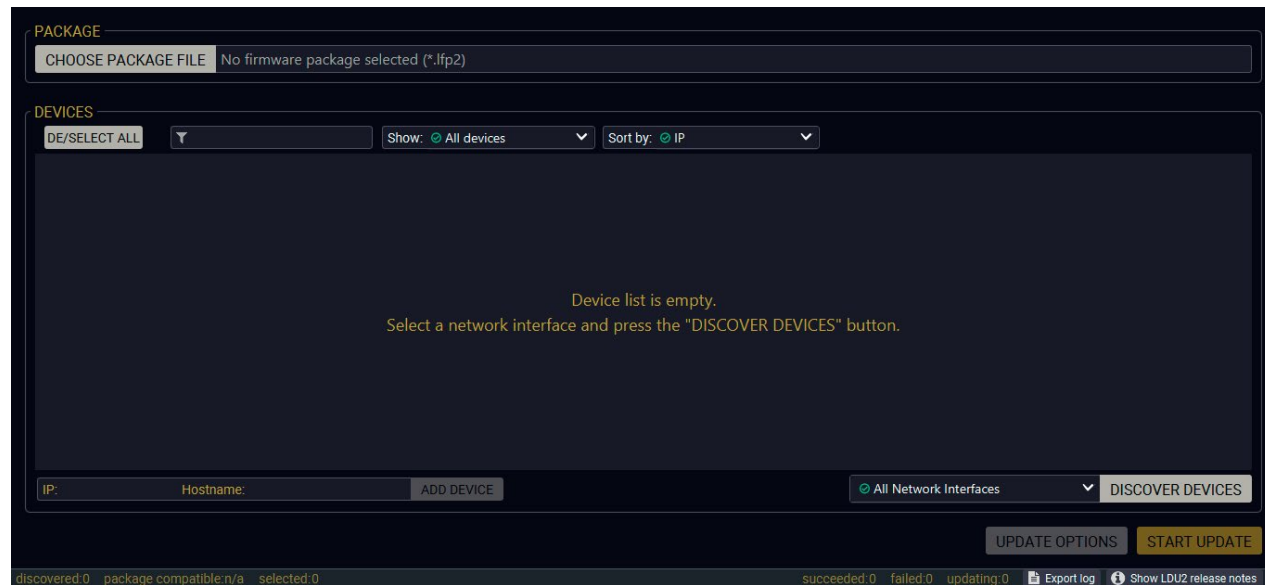

Devices may also be added manually by typing the IP address in the box near the bottom of the screen. From LDU2 version v2.16.1, manual addition of devices can also be done using the host name.

ATTENTION! If the device cannot be added by the host name, please use the IP address.

If you start the software by double-clicking on the LFP2 file, the firmware will be loaded. Press the **Search for devices** button; all the devices will be listed that are compatible with the selected firmware pack.

INFO: If you press the **Choose package file** button, the release notes of the LFP2 file will be displayed in the right panel; see the [Step 1. Select the Firmware Package.](#) section.

Device List

When the discovery has completed, the devices available on the network are listed in the application.

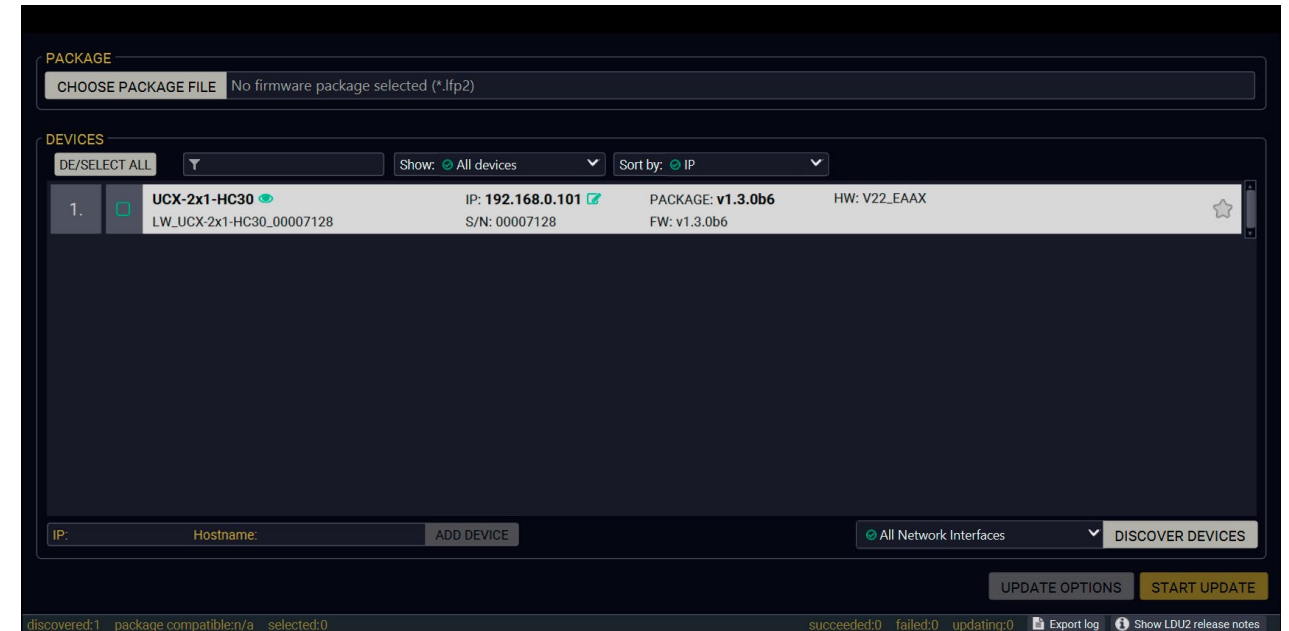

Legend of the Icons

- IP address editor** The IP address of the device can be changed in the pop-up window.
- Identify me** Clicking on the icon makes the front panel LEDs blink for 10 seconds, which helps identify the device physically.
- Authentication required** The password-protection is enabled. You have to enter the password to perform the firmware update in the pop-up window at the beginning of the update.
- Favorite device** The device has been marked, thus the IP address is stored. When a device is connected with that IP address, the star will be highlighted in that line.
- Further information available** Device is unreachable. Change the IP address using the front panel LCD menu or the IP address editor of the LDU2.

9.4. Updating Via GUI

To update the desired device(s) via the Graphical User Interface, follow these steps.

ATTENTION! The computer that runs LDU2 and the target device (that will be updated) must be in the same subnet. The update cannot be performed from behind a firewall or gateway.

ATTENTION! Updating with firmware version v2.0 or earlier will call factory reset on the device and all user settings will be lost. Upwards of firmware package v2.0, device configuration can be kept.

ATTENTION! While the firmware is being updated, the normal operation mode is suspended, as the device is switched to bootload mode. Signal processing is not performed. Do not interrupt the firmware update. If any problem occurs, reboot the unit and restart the process.

Device Cloning – Configuration Backup and Restore feature supports copying all the settings from one device to another, but cloning is only possible between devices using the same firmware. Uploading of the firmware package happens on http (80) and https (443) ports, so one of them has to be enabled.

Step 1. Select the Firmware Package.

Click on the **Choose package file** button and navigate to the location where the LFP2 file was saved. When you click on the name of the package, the preview of the release notes is displayed in the right panel.

CHOOSE PACKAGE FILE

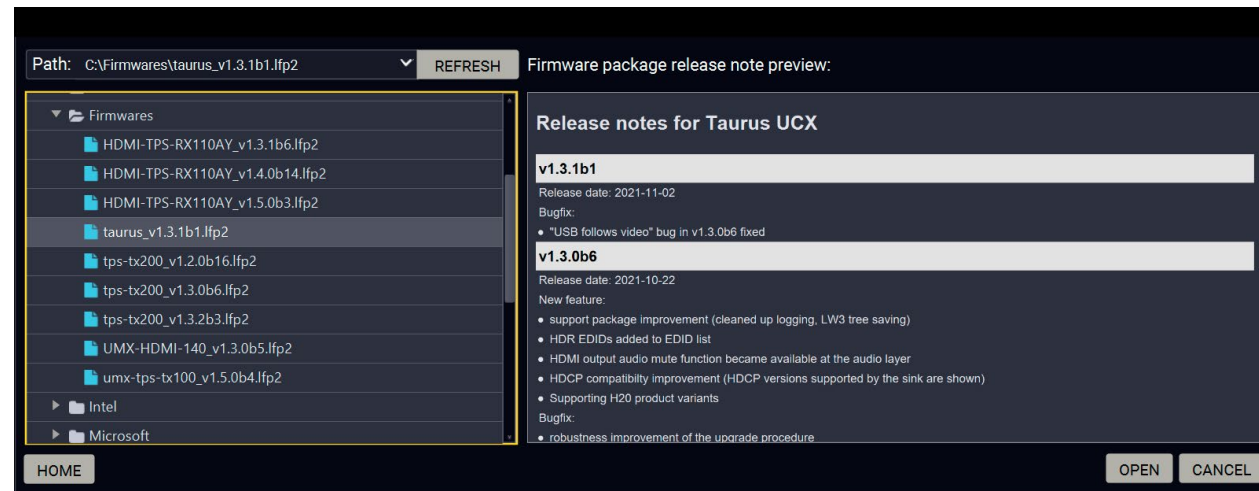

After the package file is loaded, the list is filtered to show the compatible devices only. The current firmware version of the device is highlighted in orange if it is different from the version of the package loaded.

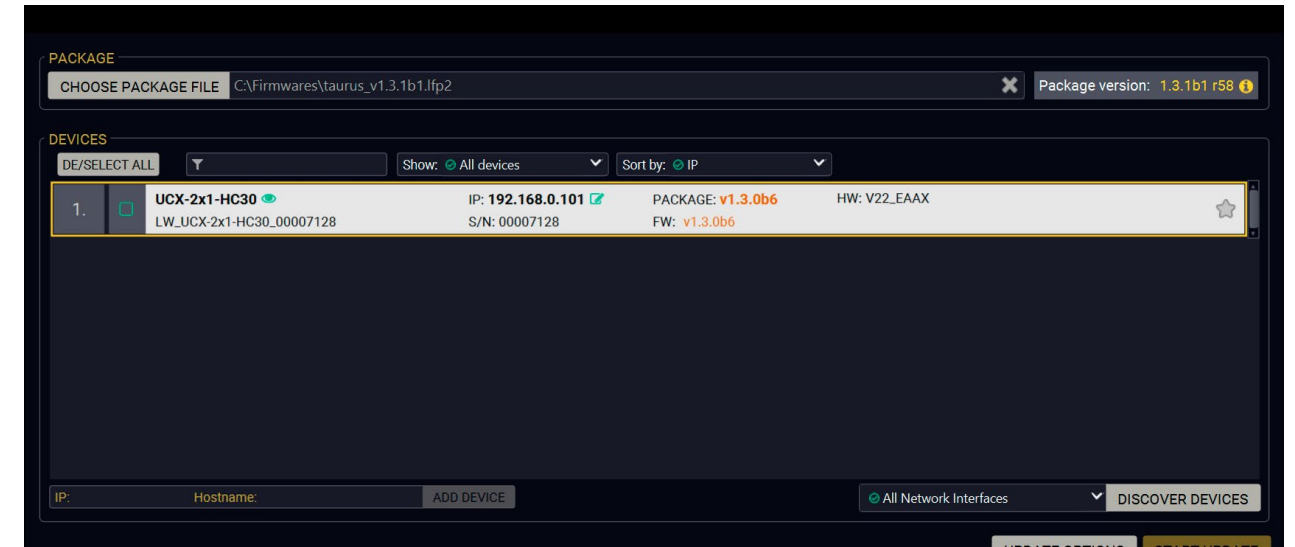

Supported models

For the table showing the different models with their compatible FW versions, please see the [Firmware Compatibility Table](#) section.

If you start the update by double-clicking on the LFP file, the screen above will be loaded right away.

INFO: The -LCC models have the same values as non-LCC models.

The Meaning of the Symbols



Show details

The log about the updating process of the device can be displayed in a new window.



Service mode

The device is in bootload mode. Backup and restore cannot be performed in this case.

Step 2. Select the desired devices for updating

Select the devices for updating; the selected line will be highlighted in green.

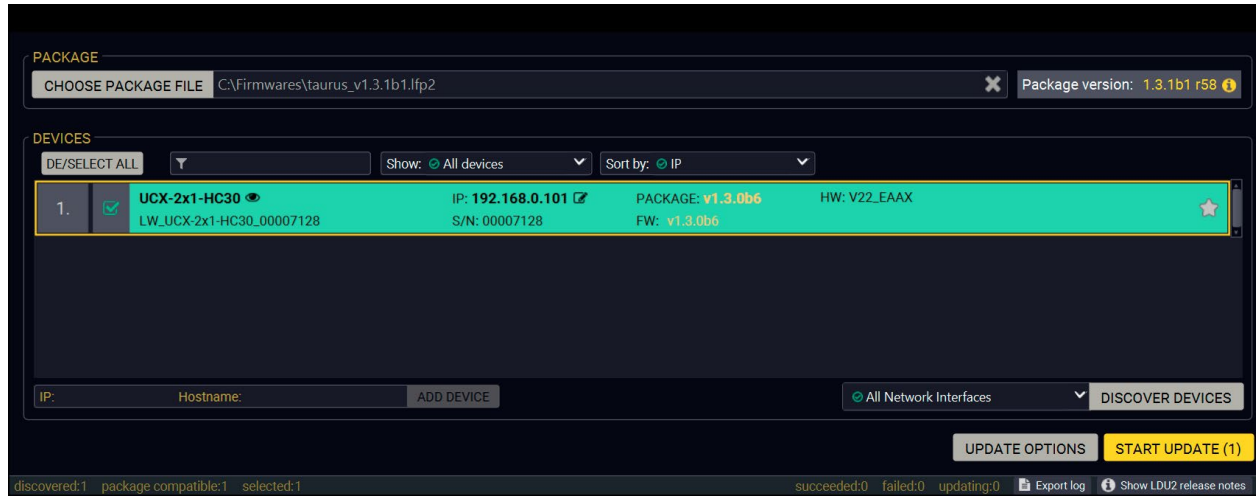

Step 3. Start the update and wait until it is finished.

Click on the **Start Update** button to start the procedure. The status is shown in percent in the right side of the device line and the overall process in the bottom progress bar. The device might reboot during the firmware update procedure.

START UPDATE (1)

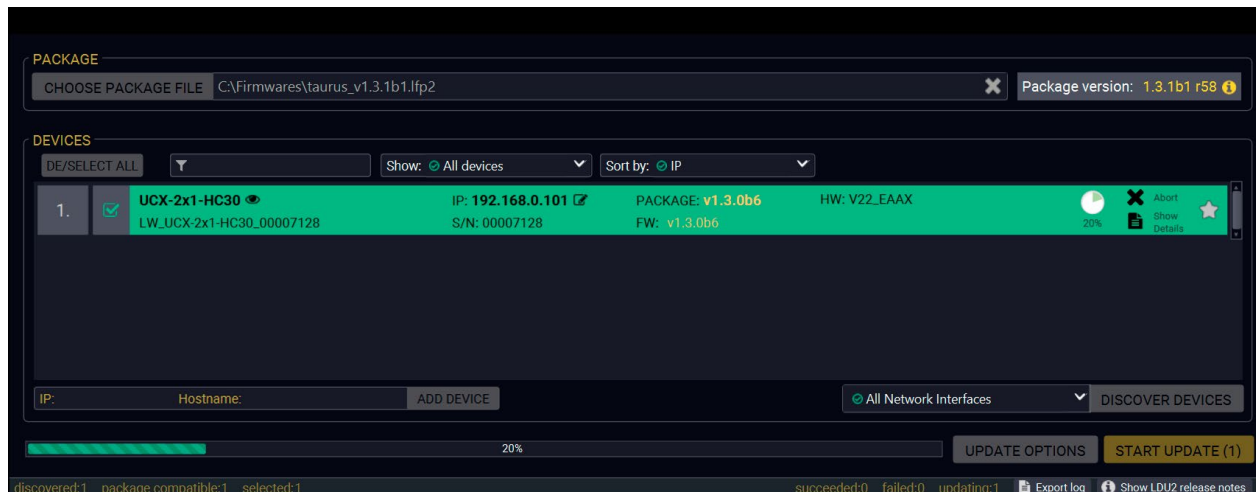

When the progress bar reaches 100% (**Done** is displayed at all devices), the update of all devices are finished successfully and a message appears; you can close the software.

Step 4. Wait until the unit reboots with the new firmware.

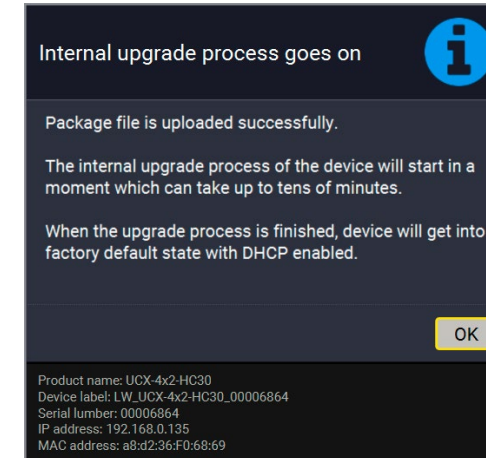

Once the firmware update procedure is completed, the device is rebooted with the new firmware. Shutting down and restarting the device is recommended.

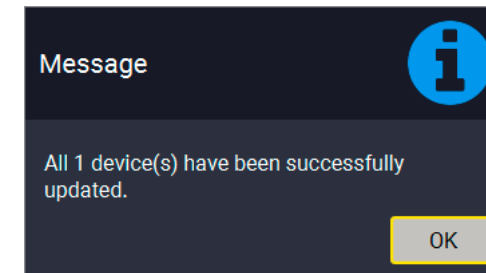

9.5. Command Line Interface (CLI)

DIFFERENCE: The Command Line Interface is available from LDU2 v2.9.0b9.

The CLI of the LDU2 software is a simple tool for creating scriptable device updates without the need of human interactions. It allows batch updating just like in case of GUI usage.

9.5.1. How to Run

Running under Windows® OS

The installer of LDU2 puts the following file into the installation folder:

`LightwareDeviceUpdaterV2_CLI.cmd`

CLI is available via this file, the exe is not suitable for that purpose. Open a command line window to execute or test the features directly.

Step 1. Open an Explorer window where the cmd file is located, the default is:

```
c:\Program Files (x86)\Lightware\Lightware Device Updater V2\
LightwareDeviceUpdaterV2_CLI.cmd.
```

Step 2. Click on the address line (highlighted in blue in the picture), type `cmd.exe` and press enter. The command interpreter window of Windows is opened at the path of the LDU2 install folder.

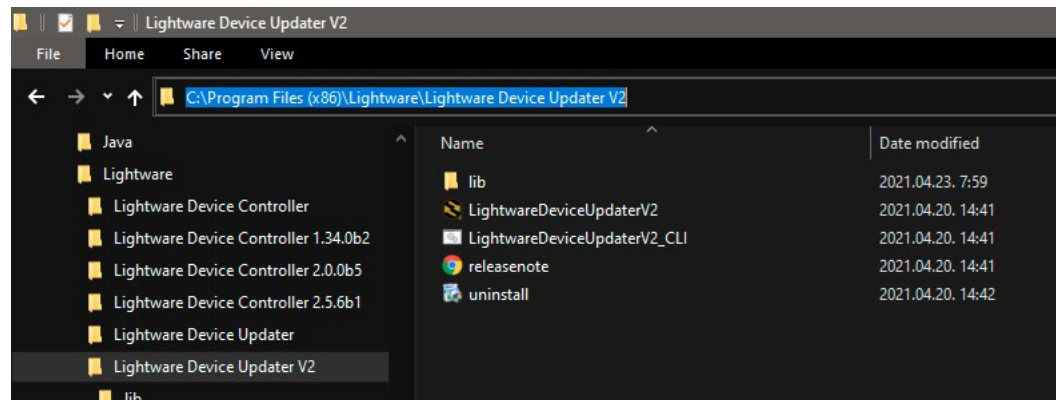

Step 3. Now you can use the `LightwareDeviceUpdaterV2_CLI.cmd` file with the commands and options, which are described in the coming sections:

Running under Linux

The Command Line Interface under Linux Operating Systems can be run by the following:

`LightwareDeviceUpdaterV2.sh`.

Running an update:

```
bash LightwareDeviceUpdaterV2.sh update --ip 172.24.5.27 --package ~/
Downloads/taurus_v1.2.0b9.lfp2
```

The commands and options are the same under Windows® and Linux, too. Following sections contain examples with `LightwareDeviceUpdaterV2_CLI.cmd`.

9.5.2. How to Use

Command Structure

The commands can be run over CLI in the following way:

`LightwareDeviceUpdaterV2_CLI.cmd [command] [options]`

[Command]: a certain command described in the coming sections; only one command can be run at a time

[Options]: mandatory and/or optional parameters of the command, if any. Optional parameters have a default value, which can be found at each affected command. You only have to define the parameter if you want to apply a different value. The **order of the options** is arbitrary.

Important Notes

- CLI is **case-sensitive** (including commands, options and other parameters).
- There is **no limit** regarding the number of the devices to update. At most 20 devices are updated simultaneously, when one of them is finished, the following (21st) will be started automatically.
- If an update is failed, the IP address of the affected device(s) are listed at the end.
- The computer that runs LDU2 and the target device (that will be updated) must be in the same subnet. The update cannot be performed from behind a firewall or gateway.

9.6. CLI Commands

INFO: The commands and options described in the following sections are the same under Windows® and Linux, too. The examples contain `LightwareDeviceUpdaterV2_CLI.cmd`.

About the Examples

- Sent command is in **blue**, response is in **grey**.
- If the response in practice is **longer than listed** in the example, this symbol can be seen: [. . .].

9.6.1. Help

The defined commands and options can be listed by the `help` command.

Command

`LightwareDeviceUpdaterV2_CLI.cmd help`

Example

```
C:\Program Files (x86)\Lightware\Lightware Device Updater V2>LightwareDeviceUpdaterV2_CLI.cmd
help

C:\Program Files (x86)\Lightware\Lightware Device Updater V2>lib\jre\bin\java.exe -jar lib\
ldu2.jar help
Command line usage:
  Win: LightwareDeviceUpdaterV2_CLI.cmd [command] [options]
  Linux: LightwareDeviceUpdaterV2.sh [command] [options]

Commands:
  * help
  * version
  * update
  * deviceInfo
  * restore
  * packageOptions
[...]
```

9.6.2. LDU2 Version

The response shows the version of the LDU2 and the version of the Script API (the Application Programming Interface that is used by the LDU2 and the script).

Command

```
LightwareDeviceUpdaterV2_CLI.cmd version
```

Example

```
C:\Program Files (x86)\Lightware\Lightware Device Updater V2>LightwareDeviceUpdaterV2_CLI.cmd
version

C:\Program Files (x86)\Lightware\Lightware Device Updater V2>lib\jre\bin\java.exe -jar lib\
ldu2.jar version
LDU2 version: 2.10.0b6
Script API version: 1.3.10
```

9.6.3. Check For New LDU2 Version

The following command can be used to check if an update of LDU2 is available. This is just a request, since the CLI is not suitable for handling the complete installer of the software.

Command

```
LightwareDeviceUpdaterV2_CLI.cmd checkForUpdates
```

Example 1

```
c:\Program Files (x86)\Lightware\Lightware Device Updater V2>LightwareDeviceUpdaterV2_CLI.cmd
checkForUpdates

c:\Program Files (x86)\Lightware\Lightware Device Updater V2>lib\jre\bin\java.exe -jar lib\
ldu2.jar checkForUpdates
Current LDU2 version: 2.10.0b6
LDU2 is up-to-date
```

Example 2

```
c:\Program Files (x86)\Lightware\Lightware Device Updater V2>LightwareDeviceUpdaterV2_CLI.cmd
checkForUpdates

c:\Program Files (x86)\Lightware\Lightware Device Updater V2>lib\jre\bin\java.exe -jar lib\
ldu2.jar checkForUpdates
Current LDU2 version: 2.9.1b1
New version is available online: 2.10.0b6
Download URL: http://update.lightware.hu/ldu2/lwr/v2.10.0b6/install_LDU2_v2.10.0b6.exe
```

9.6.4. Device Info

The most important information about the selected device is displayed; see the example for more details.

Command

```
LightwareDeviceUpdaterV2_CLI.cmd deviceInfo [options]
```

Options

Option	Description	Required?
-i or --ip	List of IP addresses of devices to be updated	one of them is mandatory
-n or --hostName	List of host names of devices to be updated	
-v or --packageVersion	Shows installed package version only	optional

Example 1

```
C:\Program Files (x86)\Lightware\Lightware Device Updater V2>LightwareDeviceUpdaterV2_CLI.cmd deviceInfo --ip 192.168.0.100

C:\Program Files (x86)\Lightware\Lightware Device Updater V2>lib\jre\bin\java.exe -jar lib\ldu2.jar deviceInfo --ip 192.168.0.100
Product name: UCX-4x2-HC30
IP address: 192.168.0.100
Serial number: 00006864
MAC address: a8:d2:36:F0:68:69
Part number: 91310081
Device label: LW_UCX-4x2-HC30_00006864
Package version: v1.2.0b1
CPU FW version: v1.2.0b1
HW version: V20_AXAX
Operation mode: Application mode
```

Example 2

```
C:\Program Files (x86)\Lightware\Lightware Device Updater V2>LightwareDeviceUpdaterV2_CLI.cmd deviceInfo --ip 192.168.1.7 --packageVersion

C:\Program Files (x86)\Lightware\Lightware Device Updater V2>lib\jre\bin\java.exe -jar lib\ldu2.jar deviceInfo --ip 192.168.0.100 --packageVersion
v1.2.0b1
```

9.6.5. Update

This command can be used to update the firmware of the devices.

Command

```
LightwareDeviceUpdaterV2_CLI.cmd update [options]
```

Options

Option	Description	Required?
-p or --package	The path of the firmware package file	yes
-i or --ip	List of IP addresses of devices to be updated	one of them is mandatory
-n or --hostName	List of host names of devices to be updated	
-r or --reportProgress	Report update progress in percentage form. Default: false	optional
Package-specific options	Certain LFP2 packages have features that can be applied at this command; see the Package Options section.	optional

ATTENTION! The configuration is restored automatically if the factory default option is not applied in the **update** command. In that case, there is no need to run the **restore** command after the update.

Example

```
C:\Program Files (x86)\Lightware\Lightware Device Updater V2>LightwareDeviceUpdaterV2_CLI.cmd update --ip 192.168.0.52 --package f:\!!!LIGHTWARE\firmware\taurus_v1.2.0b7.lfp2 --reportProgress

C:\Program Files (x86)\Lightware\Lightware Device Updater V2>LightwareDeviceUpdaterV2_CLI.cmd update --ip 192.168.0.52 --package f:\!!!LIGHTWARE\firmware\taurus_v1.2.0b7.lfp2 --reportProgress

C:\Program Files (x86)\Lightware\Lightware Device Updater V2>lib\jre\bin\java.exe -jar lib\ldu2.jar update --ip 192.168.0.52 --package f:\!!!LIGHTWARE\firmware\taurus_v1.2.0b7.lfp2 --reportProgress
[2021-06-17 08:53:01.250] [ INFO] [ main] - Device IPs: [192.168.0.52]
[2021-06-17 08:53:09.075] [ INFO] [ main] - All the selected devices are accessible over the network.
[2021-06-17 08:53:11.097] [ INFO] [ main] - All the selected devices are compatible with the specified package.
[2021-06-17 08:53:15.067] [ INFO] [ 192.168.0.52] - Taurus UCX update process started
[2021-06-17 08:53:15.074] [ INFO] [ 192.168.0.52] - Update parameters: deviceIp: 192.168.0.52, factoryDefault: true
[2021-06-17 08:53:15.185] [ INFO] [ 192.168.0.52] - Update API version: 1.0
[2021-06-17 08:53:15.222] [ INFO] [ 192.168.0.52] - Update protocol: http://
[2021-06-17 08:53:15.223] [ INFO] [ 192.168.0.52] - Authentication type: BASIC
[2021-06-17 08:53:15.415] [ INFO] [ 192.168.0.52] - Device info: Product name: UCX-4x2-HC30, Device label: LW_UCX-4x2-HC30_00006869, Serial number: 00006869, Mac address: a8:d2:36:F0:68:69, Ip address: 192.168.0.52, Host name: , Package version: v1.2.0b6, Part number: 91310081, Hw version: V20_AXAX
[2021-06-17 08:53:15.450] [ INFO] [ 192.168.0.52] - Uploading firmware package.
[2021-06-17 08:53:16.108] [ INFO] [ProgressReporter] - Progress: 2%...
[...]
```

The lines containing "ProgressReporter" can be enabled optionally. If it is enabled, the current state is displayed every 5 seconds.

9.6.6. Package Options

Shows package-specific update options.

Command

```
LightwareDeviceUpdaterV2_CLI.cmd packageOptions [options]
```

Options

Option	Description	Required?
-p or --package	The path of the firmware package file	yes

Example

```
c:\Program Files (x86)\Lightware\Lightware Device Updater V2>LightwareDeviceUpdaterV2_CLI.cmd
packageOptions --package f:\\!!!LIGHTWARE\firmware\taurus_v1.2.0b7.lfp2

Login options:
  --user : HTTP(s) basic authentication user (Default: empty string)
  --pw   : HTTP(s) basic authentication password (Default: empty string)
```

Package option example can be seen in the following section.

9.6.7. Complex Example

The following options applied:

- Firmware is updated
- Authentication enabled

```
C:\Program Files (x86)\Lightware\Lightware Device Updater V2>LightwareDeviceUpdaterV2_CLI.cmd
update --ip 192.168.0.52 --package f:\\!!!LIGHTWARE\firmware\taurus_v1.2.0b9.lfp2 --user admin
--pw 4x2 --reportProgress

C:\Program Files (x86)\Lightware\Lightware Device Updater V2>lib\jre\bin\java.exe -jar lib\ldu2.
jar update --ip 192.168.0.52 --package f:\\!!!LIGHTWARE\firmware\taurus_v1.2.0b9.lfp2 --user
admin --pw 4x2 --reportProgress
[2021-07-01 08:35:23.421] [ INFO] [          main] - Device IPs: [192.168.0.52]
[2021-07-01 08:35:31.547] [ INFO] [          main] - All the selected devices are accessible
over the network.
[2021-07-01 08:35:33.715] [ INFO] [          main] - All the selected devices are compatible
with the specified package.
[2021-07-01 08:35:37.675] [ INFO] [ 192.168.0.52] - Taurus UCX update process started
[2021-07-01 08:35:37.682] [ WARN] [ 192.168.0.52] - This update will call factory reset on
the device. All user settings will be lost.
[2021-07-01 08:35:37.688] [ INFO] [ 192.168.0.52] - Update parameters: deviceIp:
192.168.0.52, factoryDefault: true
[2021-07-01 08:35:38.505] [ INFO] [ 192.168.0.52] - Update API version: 1.0
[2021-07-01 08:35:38.774] [ INFO] [ 192.168.0.52] - Update protocol: http://
[2021-07-01 08:35:38.776] [ INFO] [ 192.168.0.52] - Authentication type: BASIC
[2021-07-01 08:35:40.660] [ INFO] [ 192.168.0.52] - Device info: Product name: UCX-4x2-HC30,
Device label: LW UCX-4x2-HC30_00006869, Serial number: 00006869, Mac address: a8:d2:36:F0:68:69,
Ip address: 192.168.0.52, Host name: , Package version: v1.2.0b8, Part number: 91310081, Hw
version: V20_AXAX
[2021-07-01 08:35:40.728] [ INFO] [ 192.168.0.52] - Uploading firmware package.
[2021-07-01 08:35:43.736] [ INFO] [ProgressReporter] - Progress: 4%
```

```
[2021-07-01 08:35:48.744] [ INFO] [ProgressReporter] - Progress: 12%
[2021-07-01 08:35:53.759] [ INFO] [ProgressReporter] - Progress: 20%
[2021-07-01 08:35:58.770] [ INFO] [ProgressReporter] - Progress: 28%
[2021-07-01 08:36:03.772] [ INFO] [ProgressReporter] - Progress: 36%
[2021-07-01 08:36:08.788] [ INFO] [ProgressReporter] - Progress: 40%
[2021-07-01 08:36:13.794] [ INFO] [ProgressReporter] - Progress: 44%
[2021-07-01 08:36:18.802] [ INFO] [ProgressReporter] - Progress: 47%
[2021-07-01 08:36:23.809] [ INFO] [ProgressReporter] - Progress: 51%
[2021-07-01 08:36:28.815] [ INFO] [ProgressReporter] - Progress: 55%
[2021-07-01 08:36:33.825] [ INFO] [ProgressReporter] - Progress: 58%
[2021-07-01 08:36:38.828] [ INFO] [ProgressReporter] - Progress: 62%
[2021-07-01 08:36:43.835] [ INFO] [ProgressReporter] - Progress: 66%
[2021-07-01 08:36:48.842] [ INFO] [ProgressReporter] - Progress: 70%
[2021-07-01 08:36:53.855] [ INFO] [ProgressReporter] - Progress: 74%
[2021-07-01 08:36:58.868] [ INFO] [ProgressReporter] - Progress: 78%
[2021-07-01 08:37:03.871] [ INFO] [ProgressReporter] - Progress: 82%
[2021-07-01 08:37:08.875] [ INFO] [ProgressReporter] - Progress: 86%
[2021-07-01 08:37:13.889] [ INFO] [ProgressReporter] - Progress: 90%
[2021-07-01 08:37:19.737] [ INFO] [ 192.168.0.52] - Upload finished.
[2021-07-01 08:37:19.754] [ INFO] [ 192.168.0.52] - Starting internal update process. Device
is about to reboot.
[2021-07-01 08:37:20.192] [ INFO] [ 192.168.0.52] - Package file has been uploaded
successfully.
```

The device is now updating itself, which can take up to tens of minutes. When the upgrade process is complete, the device resets to factory defaults, enabling DHCP.

```
LDU2 is disconnected from the device. Please wait while the device completes the update.
[2021-07-01 08:37:20.194] [ INFO] [ 192.168.0.52] - Done
```

```
All 1 update(s) finished successfully.
```

9.6.8. Exit Codes

There is a return value in all cases when a command run is finished. Currently, three codes are defined:

Code	Displayed text	Description
0	N/A	The update performed successfully
1	Update error (ErrorCode:1)	The error happened during the update
2	CLI error (ErrorCode:2)	The error happened before starting the update

The error line contains further information about the error.

Querying the Exit Code under Windows®

```
c:\Program Files (x86)\Lightware\Lightware Device Updater V2\echo
%errorlevel%
0
```

Querying the Exit Code under Linux

```
echo $?
0
```

If this value is queried after the update and it is 0, the update performed successfully.

9.7. Updating via REST API

The **Update REST API (REpresentational State Transfer Application Public Interface)** is developed to have a standardized update interface between the Lightware device and a third-party software tool (e.g. external controller). The update means – generally – to install a new Lightware Firmware Package (LFP2) to the Lightware device. The Update REST API is part of the entire **Lightware REST API** software architecture.

The Update REST API is available over **HTTPS** and with **basic authentication** (with setting a password for the user **admin**).

For more details on updating with REST API, see the [Updating the Device via REST API](#) section.

9.8. If the Update is not successful

- Restart the process and try the update again.
- If the device cannot be switched to bootload (firmware update) mode, you can do that manually as written in the User's manual of the device. Please note that backup and restore cannot be performed in this case.
- If the backup cannot be created for some reason, you will get a message whether to continue the process without backup or stop the update. A root cause can be that the desired device is already in bootload (firmware update) mode, thus the normal operation mode is suspended and backup cannot be made.

If an update is not successful, the **Export log** button becomes red. If you press the button, you can download the log file as a ZIP package, which can be sent to Lightware Support if needed. The log files contain useful information about the circumstances to find the root cause. *#bootload*





10

Troubleshooting

Usually, if the system seems not to transport the signal as expected, the best strategy for troubleshooting is to check signal integrity through the whole signal chain starting from source side and moving forward to receiver end.















First, check the front panel LEDs and take the necessary steps according to their states. For more information about front panel LEDs of the switcher, see the [Status LEDs](#) section.





Pictogram Legend









-  Section to connections/cabling.
-  Section to front panel operation.
-  Section to LDC software.
-  Section to LW3 protocol commands.

- ▶ [USE CASE STUDIES](#)
- ▶ [HOW TO SPEED UP THE TROUBLESHOOTING PROCESS?](#)

10.1. Use Case Studies

Symptom	Root cause	Action	Refer to
Video layer			
No picture on the video output	Device(s) not powered properly	Check the switcher and the other devices if they are properly powered; try to unplug and reconnect them.	 4.6
	Cable connection problem	Cables must fit very well, check all the connectors.	 4.6
	No incoming signal	No video signal is present on the HDMI input ports. Check the source device and the HDMI cables.	 4.6
	Not the proper video port is the active one	Check the video crosspoint settings.	 3.1.1
			 6.8
			 8.6.1
	Not the proper interface is the active one	If the source/display has more connectors, check if the proper interface is selected.	
	Output port is muted	Check the mute state of output ports.	 6.8.1
 8.6.4			
Display is not able to receive the video format	Check the emulated EDID and select another (e.g. emulate the display's EDID on the input port).	 6.12.1	
		 8.13.4	
HDCP is disabled	Enable HDCP on input port(s) of the switcher.	 6.9	
		 8.6.12	
No picture on the video output + signal error rate is high, HDMI2.0 scrambling is disabled, clock rate is set 1:10	The source sends 4K signals, but the emulated EDID does not support this resolution.	 6.12.1	
		 8.13.4	

Symptom	Root cause	Action	Refer to	
No 4K60 video signal on the USB-C input	The source is not able to send 4K60Hz	Check the documentation of the source and the ability of the connected port. Certain USB-C ports are only for power and not for video transmission. The icons beside the port can help.		
	The source PC or BYOD resolution is not 4K60Hz	Check the source resolution and modify it if necessary. Certain sources require restarting.		
	The USB-C cable is not appropriate	The USB-C standard allows two cable types: the Full-Featured Type-C Cable Assembly or 2.0 Type-C Cable Assembly. The latter will not operate with 4K60Hz.	 4.5	
			Always use high-quality cables. The no-name USB 3.1 Gen1-compatible cables can use only 2 SS channels instead of 4. The minimum cable requirement is USB 3.1 Gen1-compatibility and support of Displayport HBR2.	 4.5
			The active Thunderbolt3 cable is not appropriate, because it is not compatible backwards (with USB 3.x or DP). The passive TBT3 (20Gbps) cable may be appropriate if it supports USB3 Gen1 or Gen2 and Displayport.	 4.5
	Not proper Displayport alternate mode setting	Check if the DP Altmode Policy is set to Prefer video (Force C).	 6.11.1	
			 8.12.2	

Symptom	Root cause	Action	Refer to	
USB layer				
The USB 3.x data transmission does not operate	The USB-C cable is not appropriate	The USB-C standard allows two cable types: the Full-Featured Type-C Cable Assembly or 2.0 Type-C Cable Assembly. The latter will not operate for USB3 Gen1.		4.5
		Always use a high-quality cable. Noname cables do not guarantee the USB 3.x support.		4.5
		The active Thunderbolt3 cable is not appropriate, because it is not compatible backwards (with USB 3.x). The passive TBT3 (20Gbps) cable could be proper when it supports USB3 Gen1 or Gen2.		4.5
	Not proper Displayport alternate mode setting	Check if the DPAltmode Policy is set to Prefer USB3 (Force D) or Auto.		6.11.1
				8.12.2
The USB 2.0 data transmission does not operate	IR drop level of the USB Type-C cable is low.	It can cause communication problems. Always use high quality cables.		4.5
The USB 2.0 data transmission or Power delivery do not operate	If the resistor of the conductor in USB-C cable is too high, the voltage difference could be more than 0.25V, which can cause USB 2.0 or Power Delivery communication problems.	Always use high quality cables.		4.5
Power via USB-C				
BYOD charges slowly	The BYOD needs more than 100W	An error message will appear, because the UCX series maximum power capacity is 100W.		4.3
	Not proper the power setting of the USB-C port	Check the output power setting the connected port.		6.11.1

10.2. How to Speed Up the Troubleshooting Process?

Lightware’s technical support team is always working hard to provide the fastest support possible. Our team’s response time is one of the best in the industry, and in the toughest of cases we can directly consult with the hardware or software engineer who designed the product to get the information from the most reliable source.

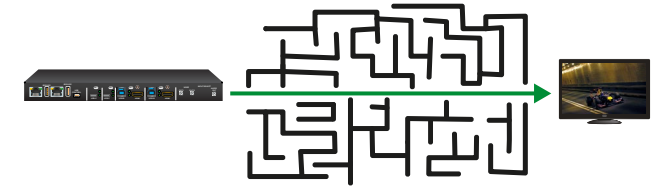

However, the troubleshooting process can be even faster... with your help.

There are certain pieces of information that push us in the right direction to find the root cause of the problem. If we receive most of this information in the first e-mail, or it is gathered at the time when you call us, then there is a pretty high chance that we will be able to respond with the final solution right away.

This information is the following:

- Schematic (a pdf version is preferred, but a hand drawing is sufficient).
- Serial number(s) of the device(s) (it is either printed somewhere on the box or you can query it in the Device Controller software or on the built-in website).
- Firmware versions of the devices (please note that there may be multiple CPUs or controllers in the device and we need to know all of their firmware versions, a screenshot is the best option).
- Cable lengths and types (in our experience, it’s usually the cable).
- Patch panels, gender changers or anything else in the signal path that can affect the transmission.
- Signal type (resolution, refresh rate, color space, deep color).
- Emulated EDID(s) (please save them as a file and send it to us).
- Actions to take in order to re-create the problem (if we cannot reproduce the problem, it is hard for us to find the cause).
- Photo or video about the problem (‘image noise’ can mean many different things, it’s better if we see it too).
- Error logs from the Device Controller software.
- In the case of an Event Manager issue, the event file and/or backup file from the Device Controller software.

The more of the information above you can give us, the better. Please send this information to the Lightware Support Team (support@lightware.com) to speed up the troubleshooting process.

11

Technologies

The following sections contain descriptions and useful technical information on how the devices work in the background. The content is based on experiences and cases we met in the practice. These sections help understand features and technical standards like the following:

- ▶ [EDID MANAGEMENT](#)
- ▶ [HDCP MANAGEMENT](#)
- ▶ [PIXEL ACCURATE RECLOCKING](#)

11.1. EDID Management

11.1.1. Understanding the EDID

The Extended Display Identification Data (EDID) is the passport of display devices (monitors, TV sets, projectors). It contains information about the capabilities of the display, such as supported resolutions, refresh rates (these are called Detailed Timings), the type and manufacturer of the display device, etc.

After connecting a source to a display (DVI, HDMI, DP), the source reads out the EDID to determine the resolution and refresh rate of the image to be transmitted.

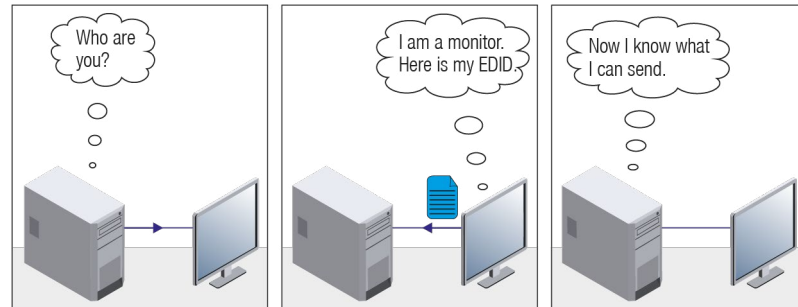

EDID Communication

Most DVI computer displays have a 128-byte-long EDID structure. However, Digital Televisions and HDMI capable displays may have another 128 bytes, which is called E-EDID and is defined by CEA (Consumer Electronics Association). This extension contains information about additional Detailed Timings, audio capabilities, speaker allocation and HDMI capabilities. It is important to know that all HDMI capable devices must have CEA extension, but not all devices with CEA extension are HDMI capable.

Common Problems Related to EDID

- Problem:** “My system consists of the following: a computer, a Lightware device, a WUXGA (1920x1200) LCD monitor, and an SXGA (1280x1024) projector. I would like to see the same image on the monitor and the projector. What EDID should I choose on the Lightware device?”
- Solution:** If you want to see the image on both displays, you need to select the resolution of the smaller display (in this case SXGA), otherwise the smaller display may not show the higher resolution image.
- Problem:** “I have changed to a different EDID on an input port of the Lightware device to have a different resolution, but nothing happens.”
- Solution:** Some graphics cards and video sources read out the EDID only after power-up and later they do not sense that the EDID has been changed. You need to restart your source to make it read out the EDID again.

11.1.2. Advanced EDID Management

Each DVI sink (e.g. monitors, projectors, plasma displays, etc...) must support the EDID data structure. Source BIOS and operating systems are likely to query the sink using DDC2B protocol to determine what pixel formats and interface are supported. DVI standard uses EDID data structure to identify the monitor type and capabilities. Most DVI sources (VGA cards, set top boxes, etc.) will output DVI signal after accepting the connected sink's EDID information. In the case of EDID readout failure or missing EDID, the source will not output DVI video signal.

Lightware devices provide the Advanced EDID Management function that helps system integration. The built-in EDID Router can store and emulate factory pre-programmed- and User programmable EDIDs. The EDID of the attached monitors or projectors for each output are stored in a non-volatile memory. This way the EDID of a monitor is available when the monitor is unplugged or switched off.

Any EDID can be emulated on any input. An emulated EDID can be copied from the EDID router's memory (static EDID emulation), or from the last attached monitor's memory (dynamic EDID emulation). For example, the Lightware device can be set up to emulate a sink device that is connected to one of the outputs. In this case, the EDID automatically changes if the monitor is replaced with another display device (as long as it has a valid EDID).

The EDID is independently programmable for all inputs without affecting each other. All inputs have their own EDID circuit.

INFO: The user is not required to disconnect the video cable to change an EDID as opposed to other manufacturer's products. The EDID can be changed even if a source is connected to the input and powered ON.

INFO: When the EDID has been changed, the router toggles the HOTPLUG signal for 2 seconds. Some sources do not sense this signal. In such cases, the source device must be restarted or powered OFF and ON again.

11.2. HDCP Management

Lightware Visual Engineering is a legal HDCP adopter. Several functions have been developed that help to solve HDCP related problems. Complex AV systems often have both HDCP and non-HDCP components. The switcher allows transmitting HDCP encrypted and unencrypted signals. The devices will be still HDCP compliant, as they will never output an encrypted signal to a non-HDCP compliant display device. If an encrypted signal is switched to a non-compliant output, a red screen alert or muted screen will appear.

11.2.1. Protected and Unprotected Content

Many video sources send HDCP protected signal if they detect that the sink is HDCP capable – even if the content is not copyrighted. This can cause trouble if an HDCP capable device is connected between the source and the display. In this case, the content cannot be viewed on non-HDCP capable displays and interfaces like event controllers. Rental and staging technicians often complain about certain laptops that always send HDCP encrypted signals if the receiver device (display, matrix router, etc.) reports HDCP compliancy. Even though HDCP encryption is not required all the time (e.g. computer desktop image), certain laptops still do that.

To avoid unnecessary HDCP encryption, Lightware introduced the HDCP enabling/disabling function: the HDCP capability can be disabled in the Lightware device. If HDCP is disabled, the connected source will detect that the sink is not HDCP capable, and turn off authentication.

11.2.2. Disable Unnecessary Encryption

HDCP Compliant Sink

All the devices are HDCP-compliant, no manual setting is required, both protected and unprotected contents are transmitted and displayed on the sink.



Not HDCP-compliant Sink 1.

Not-HDCP compliant sink is connected to the switcher. Some sources (e.g. computers) always send HDCP encrypted signals if the receiver device reports HDCP compliancy, however, HDCP encryption is not required all the time (e.g. computer desktop image). If HDCP is enabled in the switcher, the image will not be displayed on the sink.



Setting the HDCP parameter to Auto on the output port and disable HDCP on the input port, the transmitted signal will not be encrypted if the content is not protected. Thus, non-HDCP compliant sinks will display non-encrypted signal.

Not HDCP-compliant Sink 2.

The layout is the same as in the previous case: non-HDCP compliant display device is connected to the switcher but the source would send protected content with encryption. If HDCP is enabled on the input port of the switcher, the source will send encrypted signal.



The sink is not HDCP compliant, thus it will not display the video signal (but blank/red/muted/etc. screen). If HDCP is disabled on the input port of the switcher, the source will not send the signal. The solution is to replace the display device with an HDCP-capable one.

11.2.3. HDCP 2.2

HDCP 2.2 is the latest evolution of copy protection. It is designed to create a secure connection between a source and a display. The 2.x version of HDCP is not a continuation of HDCPv1, and is rather a completely different link protection. One of the main differences is the number of the allowed devices within a closed AV system: HDCP 2.2 allows 32 devices (HDCP 1.4 allows 128 devices). A further limit is that up to four level is allowed, which means the protected signal can be transmitted over at most four repeater/matrix/switcher device. HDCP content protection is activated only if an active video stream is transmitted from the source to the display. The encryption is not activated without a video signal.

HDCP 2.2 standard allows the application of a previous version of HDCP (e.g. HDCP 1.4) between the source and the display if the source device allows it. According to the standard, if the image content is protected with HDCP, the highest supported content protection level has to be applied. However, if the highest level of protection is not justified by the source content, the level may be decreased to avoid compatibility problems; this case is determined by the source.

HDCP 2.2 Source and HDCP 1.4 Sink

In this case the signal of an HDCP 2.2 compliant source is switched to an HDCP 1.4 compliant sink device. The signal is encrypted with HDCP 2.2 on the input and encrypted with HDCP 1.4 on the output of the Lightware device. A lower level of encryption may be applied only if the source device/content allows it - according to the HDCP standard. In this case the HDCP setting on the input port has to be set to HDCP 1.4 and Depends on input on the output port.



HDCP 1.4 Source and HDCP v2.2 Sink

The example below is the reversal of the previous case. An HDCP 1.4 compliant source sends a signal with HDCP 1.4 encryption. The signal is switched to an HDCP 2.2 compliant sink device. In this case the outgoing signal has to be encrypted with the highest supported encryption level towards the sink, as the Lightware device and the sink are both HDCP 2.2 compliant. The HDCP 2.2 standard does not allow keeping the original HDCP 1.4 encryption level on the output.



What Kind of Signal Will be on the Output of the Lightware Device?

See below table that summarizes the possible cases:

Incoming Signal	HDCP 1.4 Compatible Sink on the Output	HDCP 2.2. Compatible Sink on the Output
HDCP 1.4	HDCP 1.4	HDCP 2.2
HDCP 2.2 (convertable)*	HDCP 1.4	HDCP 2.2
HDCP 2.2 (not convertable)*	Red screen	HDCP 2.2

* Stream type 0: the video stream allows the conversion of the signal to apply a lower level of encryption.

** Stream type 1: the video stream does not allow the conversion of the signal.

11.3. Pixel Accurate Reclocking

Signal reclocking is an essential procedure in digital signal transmission. After passing the reclocking circuit, the signal becomes stable, jitter-free, and can be transmitted over more equipment like processors or event controllers. Without reclocking, sparkles, noise, and jaggies appear on the image.

Lightware's sophisticated Pixel Accurate Reclocking technology fixes more problems than general TMDS reclocking. It removes not only intra-pair skew, but inter-pair skew as well. The Pixel Accurate Reclocking circuit eliminates the following errors:

Intra-pair skew

Skew between the + and - wires within a differential wire pair (e.g. Data2- and Data2+). It's caused by different wire lengths or slightly different wire construction (impedance mismatch) in the DVI cable. It results in jitter.

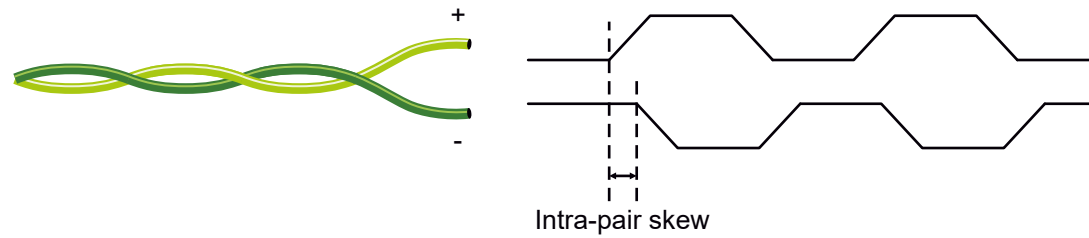

Inter-pair skew

Skew between two differential wire pairs in a cable. It is caused by different wire pair lengths or different number of twists in the DVI cable. Too much inter-pair skew results in color shift in the picture or sync loss.

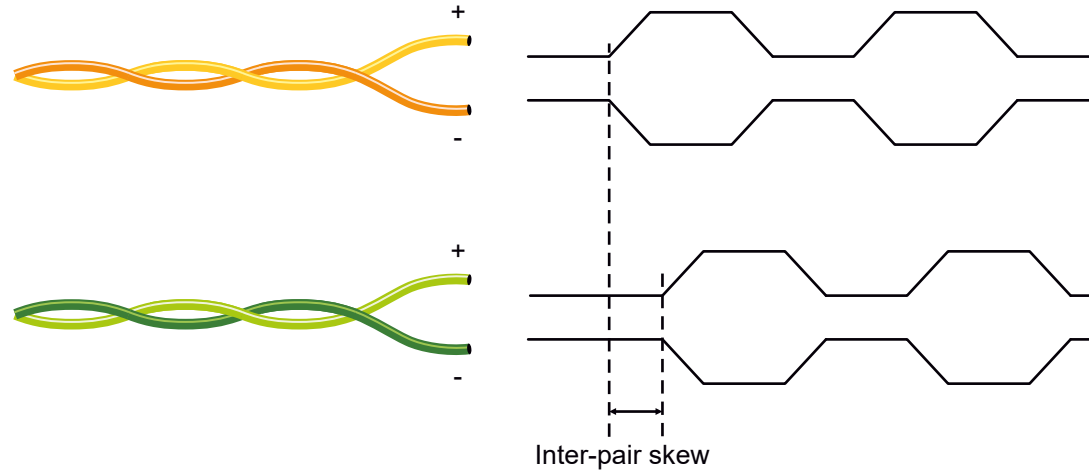

Jitter

Signal instability in the time domain. The time difference between two signal transitions should be a fixed value, but noise and other effects cause variations.

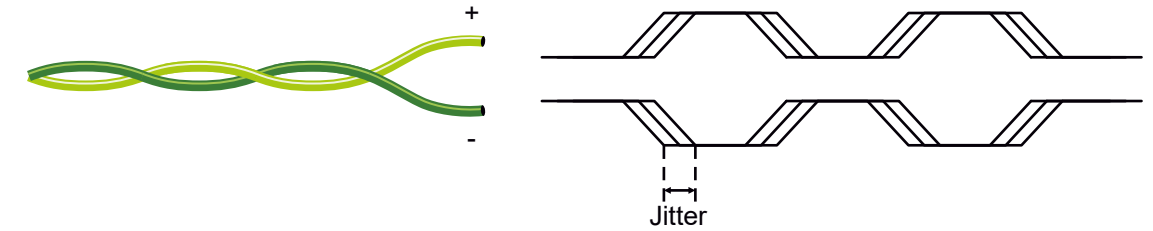

Noise

Electromagnetic interference between other electronic devices such as mobile phones, motors, etc. and the DVI cable are coupled onto the signal. Too much noise results in increased jitter.

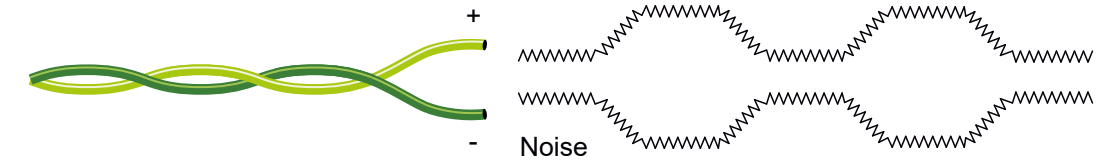

12

Appendix

Tables, drawings, guides, technical details and hashtag keyword list as follows:

- ▶ SPECIFICATIONS
- ▶ PORT NUMBERING
- ▶ APPLIED PORTS (NETWORK SETTINGS)
- ▶ FACTORY EDID LIST
- ▶ CABLE WIRING GUIDE
- ▶ MECHANICAL DRAWINGS
- ▶ CONTENT OF THE BACKUP FILE
- ▶ FIRMWARE COMPATIBILITY TABLE
- ▶ FACTORY DEFAULT SETTINGS
- ▶ FIRMWARE RELEASE NOTES
- ▶ HASHTAG KEYWORD LIST
- ▶ FURTHER INFORMATION

12.1. Specifications

General

Compliance	CE; UKCA
Electrical safety	EN 62368-1:2020
EMC (emission)	EN 55032:2015+A1:2020
EMC (immunity)	EN 55035:2017+A11:2020
RoHS	EN 63000:2018
Warranty	3 years
Operating temperature	0° to +50°C (+32° to +122°F)
Operating humidity	10% to 90%, non-condensing
Cooling	Passive

Power

Power supply option	External Power Supply
Supported power source	100-240 V AC; 50/60 Hz
Supplied power	24V DC, 5A
AC power plug	Interchangeable (EU, UK, JP/US, AUS/NZ)
Battery cell type	BR1632A

UCX-2x1-HC30

Power consumption (max., measured) ¹	69.8 W
Heat dissipation	239 BTU/h (max)

UCX-2x1-HC40

Power consumption (max., calculated) ¹	70 W
Heat dissipation	239 BTU/h (max)

UCX-2x2-H30

Power consumption (max., measured)	13.3 W
Heat dissipation	46 BTU/h (max)

UCX-2x2-H40

Power consumption (max., calculated)	16 W
Heat dissipation	55 BTU/h (max)

UCX-4x2-HC30

Power consumption (max., measured) ²	137.3 W
Heat dissipation	469 BTU/h (max)

UCX-4x2-HC40

Power consumption (max., calculated) ²	138 W
Heat dissipation	471 BTU/h (max)

UCX-4x2-HC30D

Power consumption (max) ²	137.8 W
Heat dissipation	471 BTU/h (max)

UCX-4x2-HC40D

Power consumption (max, calculated) ²	138 W
Heat dissipation	471 BTU/h (max)

UCX-4x3-HC40-BD

Power consumption (max, calculated) ²	137.8 W
Heat dissipation	471 BTU/h (max)

UCX-4x3-HC40

Power consumption (max) ²	137.3 W
Heat dissipation	469 BTU/h (max)

² Counting with 450mA power over the HDMI outputs and 120W over the USB-C ports.

DCX-2x1-HC10

Power consumption (max) ¹	109.8 W
Heat dissipation	375 BTU/h (max)

¹ Counting with 450mA power over the HDMI output and 100W over the USB-C port.

DCX-3x1-HC20

Power consumption (max, calculated) ¹	130 W
Heat dissipation	444 BTU/h (max)

¹ Counting with 450mA power over the HDMI output and 100W over the USB-C port.

Enclosure**UCX-2x1-HC30, -HC40, UCX-2x2-H30, -H40, UCX-4x2-HC30, -HC40, UCX-4x3-HC40, DCX-2x1-HC10, DCX-3x1-HC20**

Enclosure material	1 mm steel
Dimensions in mm	246 W x 140,3 D x 26 H
Dimensions in inch	9.59 W x 5.57 D x 1.01 H
Weight (UCX-2x1-HC30, UCX-2x1-HC40)	895 g (1.97 lb)
Weight (UCX-2x2-H30, UCX-2x2-H40)	898 g (1.98 lb)
Weight (UCX-4x2-HC30, UCX-4x2-HC40)	918 g (2.02 lb)
Weight (UCX-4x3-HC40)	914 g (2.02 lb)
Weight (DCX-2x1-HC10)	860 g (1.9 lb)
Weight (DCX-3x1-HC20)	901 g (1.99 lb)

UCX-4x2-HC30D, UCX-4x2-HC40D, UCX-4x3-HC40-BD

Enclosure material	1 mm steel
Dimensions in mm	271 W x 150 D x 26 H
Dimensions in inch	10.67 W x 5.9 D x 1.02 H
Weight (UCX-4x2-HC30D)	968 g (2.13 lb)
Weight (UCX-4x2-HC40D)	997 g (2.2 lb)
Weight (UCX-4x3-HC40-BD)	970 g (2.14 lb)

Video Inputs**USB-C input**

Connector type	24-pole USB type C receptacle
AV standard	DP 1.2a
HDCP compliance	HDCP 1.4, HDCP 2.2
Color space	RGB, YCbCr
Video delay	0 frame
Max. video resolution	4096x2160@60Hz RGB 4:4:4 (up to 600MHz pixel clock); 1920x1080@120 Hz, 36 bit
Audio formats	all formats in line with HDMI 2.0 standard
3D support	yes

HDMI input

Connector type	19-pole HDMI Type A receptacle (with screw locking option)
----------------	--

AV standard	DVI 1.0, HDMI 1.4, HDMI 2.0
Maximum data rate	18Gbps
Maximum pixel clock	597MHz
HDCP compliance	HDCP 1.4, HDCP 2.2
Color space	RGB, YCbCr
Video delay	0 frame
Max. video resolution	4096x2160@60Hz RGB 4:4:4 (up to 600MHz pixel clock); 1920x1080@120 Hz, 36 bit
Max. input HDMI cable length (with premium certified cable) at 3840x2160@60Hz 4:4:4	5m
Reclocking	Pixel Accurate Reclocking
3D support	yes
Audio mode	Simultaneous pass-through and de-embedding to the Audio layer
Supported audio formats for pass-through	All HDMI2.0 audio formats
Supported audio formats for de-embedding	Uncompressed
Compressed	Dolby Digital, DTS; Compressed HBR; Dolby TrueHD, DTS-HD

Video Outputs**HDMI output**

Connector type	19-pole HDMI Type A receptacle
AV standard	DVI 1.0, HDMI 1.4, HDMI 2.0
HDCP compliance	HDCP 1.4, HDCP 2.2
Color space	RGB, YCbCr
Supported resolutions at 8 bits/color *	up to 4096x2048@60Hz (4:4:4) or 4096x2048@60Hz (4:2:0); up to 3840x2160@60Hz (4:4:4) or 3840x2160@60Hz (4:2:0); 1920x1080@60Hz (4:4:4) up to 12 bits/color
Audio formats	8 channel PCM, Dolby TrueHD; DTS-HD Master Audio 7.1

* All standard VESA and CEA resolutions up to 300MHz (HDMI1.4) and other custom resolutions up to 300Mhz are supported.

Audio Ports**Analog audio output**

Connector type	5-pole Phoenix connector
Audio formats	2-ch PCM
Sampling frequency	48 kHz
Volume	-95.62 dB - 0 dB
Balance	-100 - +100 (0 = center)

Dante® Audio Output Port

Connector type	RJ45 female connector
Signal transmission	Dante® or AES67
Supported channels	2-channel stereo
Sampling rates	44.1, 48, 88,2, 96 kHz

Control Ports**Ethernet port**

Connector type	RJ45 female connector
Ethernet data rate	10/100Base-T, full duplex with autodetect
Power over Ethernet (PoE)	Not supported

GPIO port

Connector type	8-pole Phoenix
Function (pin 1-6)	Configurable (input/output)
Function (pin 7)	5V output
Function (pin 8)	Ground

OCS port

Connector type	3-pole Reversed Gender Plug Phoenix connector
Number of configurable pins	1
Port direction	Input

USB port

Connector type	C-type receptacle
USB compliance	USB 3.1 Gen1
Connector type	A-type receptacle
USB compliance	USB 2.0, USB 3.1 Gen1
Connector type	B-type receptacle

USB compliance	USB 3.0
Connector type	mini-B type
USB compliance	USB 2.0

RS-232 port

Connector type	3-pole Phoenix connector
Baud rates	between 9600 and 115200 baud
Data bits	8
Parity	None / Odd / Even
Stop bits	1 / 2
Output voltage: Low level	3 - 15V
Output voltage: High level	-15V - 3V

- INFO: Specifications are subject to change without notice.
- INFO: The -LCC models have the same values as non-LCC models.

12.2. Port Numbering

INFO: The -LCC models have the same values as non-LCC models.

Audio/Video Ports - HC30 models

Model name		UCX-2x1-HC30		UCX-2x2-H30		UCX-4x2-HC30		UCX-4x2-HC30D	
Port name		Video port nr.	Audio port nr.	Video port nr.	Audio port nr.	Video port nr.	Audio port nr.	Video port nr.	Audio port nr.
Inputs	USB-C in 1	I1	I1	-	-	I1	I1	I1	I1
	USB-C in 2	-	-	-	-	I2	I2	I2	I2
	HDMI in 3	I2	I2	I1	I1	I3	I3	I3	I3
	HDMI in 4	-	-	I2	I2	I4	I4	I4	I4
	Welcome Screen	I5	-	I5	-	I5	-	I5	-
Outputs	HDMI out 1	O1	O1	O1	O1	O1	O1	O1	O1
	HDMI out 2	-	-	O2	O2	O2	O2	O2	O2
	Analog audio out	-	O2	-	O3	-	O3	-	O3
	Dante audio out	-	-	-	-	-	-	-	O3

Audio/Video Ports - HC40 models

Model name		UCX-2x1-HC40		UCX-2x2-H40		UCX-4x2-HC40		UCX-4x2-HC40D		UCX-4x3-HC40		UCX-4x3-HC40-BD	
Port name		Video port nr.	Audio port nr.	Video port nr.	Audio port nr.	Video port nr.	Audio port nr.	Video port nr.	Audio port nr.	Video port nr.	Audio port nr.	Video port nr.	Audio port nr.
Inputs	USB-C in 1	I1	I1	-	-	I1	I1	I1	I1	I1	I4	I1	I1
	USB-C in 2	-	-	-	-	I2	I2	I2	I2	I2	I2	I2	I2
	HDMI in 3	I2	I2	I1	I1	I3	I3	I3	I3	I3	I3	I3	I3
	HDMI in 4	-	-	I2	I2	I4	I4	I4	I4	I4	I4	I4	I4
	Welcome Screen	I5	-	I5	-	I5	-	I5	-	I5	-	I5	-
Outputs	HDMI out 1	O1	O1	O1	O1	O1	O1	O1	O1	O1	O1	O1	O1
	HDMI out 2	-	-	O2	O2	O2	O2	O2	O2	O2	O2	O2	O2
	HDMI out 3	-	-	-	-	-	-	-	-	O3	O3	O3	O3
	Analog audio out	-	O2	-	O3	-	O3	-	O3	O4	O4	O4	O4
	Dante audio out*	-	-	-	-	-	-	-	O3	-	-	-	O4

* In case of UCX-4x3-HC40-BD the Dante audio port also functions as input.

Audio/Video Ports - DCX models

Model name		DCX-2x1-HC10		DCX-3x1-HC20	
Port name		Video port nr.	Audio port nr.	Video port nr.	Audio port nr.
Inputs	USB-C in 1	I1	I1	I1	I1
	USB-C in 2	-	-	-	-
	HDMI in 3	I2	I2	I2	I2
	HDMI in 4	-	-	I3	I3
	Welcome Screen	I5	-	I5	-
Outputs	HDMI out 1	O1	O1	O1	O1
	HDMI out 2	-	-	-	-
	HDMI out 3	-	-	-	-
	Analog audio out	-	O2	O2	O2

USB Ports - HC30 models

Model name		UCX-2x1-HC30	UCX-2x2-H30	UCX-4x2-HC30	UCX-4x2-HC30D
Port name		USB port nr.			
Upstream Facing Ports	USB-C Host 1	U1	-	U1	U1
	USB-C Host 2	-	-	U2	U2
	USB-B Host 3	U2	U1	U3	U3
	USB-B Host 4	-	U2	U4	U4
USB Hub/Downstream Port	USB hub	H1	H1	H1	H1
	USB Device 1	D1	D1	D1	D1
	USB Device 2	D2	D2	D2	D2
	USB Device 3	D3	D3	D3	D3
	USB Device 4	D4	D4	D4	D4

USB Ports - HC40 models

Model name		UCX-2x1-HC40	UCX-2x2-H40	UCX-4x2-HC40	UCX-4x2-HC40D	UCX-4x3-HC40	UCX-4x3-HC40-BD
Port name		USB port nr.					
Upstream Facing Ports	USB-C Host 1	U1	-	U1	U1	U1	U1
	USB-C Host 2	-	-	U2	U2	U2	U2
	USB-B Host 3	U2	U1	U3	U3	U3	U3
	USB-B Host 4	-	U2	U4	U4	U4	U4
USB Hub/Downstream Port	USB hub	H1	H1	H1	H1	H1	H1
	USB Device 1	D1	D1	D1	D1	D1	D1
	USB Device 2	D2	D2	D2	D2	D2	D2
	USB Device 3	D3	D3	D3	D3	D3	D3
	USB Device 4	D4	D4	D4	D4	D4	D4
	Dante audio in	-	-	-	-	-	DANTE_IN

USB Ports - DCX models

The USB-C port of the DCX models does not transmit USB data.

Ethernet Ports - HC30 models

Model name	UCX-2x1-HC30	UCX-2x2-H30	UCX-4x2-HC30	UCX-4x2-HC30D
Port name	USB port nr.			
Secure Eth 1	P1	P1	P1	P1
Utility Eth 2	P2	-	P2	P2
Utility Eth 3	P3	-	P3	P3
USB-C in1 (Eth)	P4	-	P4	P4
USB-C in2 (Eth)	P5	-	P5	P5

Ethernet Ports - HC40 models

Model name	UCX-2x1-HC40	UCX-2x2-H40	UCX-4x2-HC40	UCX-4x2-HC40D	UCX-4x3-HC40	UCX-4x3-HC40-BD
Port name	USB port nr.					
Ethernet 1	P1	P1	P1	P1	P1	P1
Ethernet 2	P2	-	P2	P2	P2	P2
Ethernet 3	P3	-	P3	P3	P3	P3
USB-C in1	P4	-	P4	P4	P4	P4
USB-C in2	P5	-	P5	P5	P5	P5

Ethernet Ports - DCX models

Model name	DCX-2x1-HC10	DCX-3x1-HC20
Port name	USB port nr.	
Ethernet 1	P1	P1
Ethernet 2	-	P2
Ethernet 3	-	P3
USB-C in1	P2	P4

GPIO

Port name	Port nr.
GPIO1	P1
GPIO2	P2
GPIO3	P3
GPIO4	P4
GPIO5	P5
GPIO6	P6

OCS

Port name	Port nr.
OCS1	P1

RS-232 Ports

Port name	Port nr.	Serial over IP port nr.
Rs232 1	P1	8001
Rs232 2	P2	8002

12.3. Applied Ports (Network Settings)

The following ports are necessary to pass via a network switch/firewall for a proper working between the device and the software:

Purpose/function	Protocol	Port nr.
Firmware update TFTP	UDP	69
	UDP	49990
	UDP	49995
Device Discovery	UDP	224.0.0.251:5353
Remote IP	UDP	230.76.87.82:37421
HTTP - file transfer and update API	TCP	80
HTTPS - file transfer and update API	TCP	443
LW3 control API	TCP	6107

WARNING! Enabling LARA on your device will open TCP ports 20,000 to 30,000 for service deployment. These ports will not be protected or filtered by the device's firewall, making them accessible from the device's network interfaces. Please be aware that running services on these ports could expose potential vulnerabilities on the device. Make sure to only activate services that have undergone thorough testing and do not contain any vulnerabilities.

12.4. Factory EDID List

Mem	Resolution	Type	EDID features
F1	640 x 480p @ 60.00 Hz	D	DVI
F2	848 x 480p @ 60.00 Hz	D	DVI
F3	800 x 600p @ 60.32 Hz	D	DVI
F4	1024 x 768p @ 60.00 Hz	D	DVI
F5	1280 x 768p @ 50.00 Hz	D	DVI
F6	1280 x 768p @ 59.94 Hz	D	DVI
F7	1280 x 768p @ 75.00 Hz	D	DVI
F8	1360 x 768p @ 60.02 Hz	D	DVI
F9	1280 x 1024p @ 50.00 Hz	D	DVI
F10	1280 x 1024p @ 60.02 Hz	D	DVI
F11	1280 x 1024p @ 75.02 Hz	D	DVI
F12	1400 x 1050p @ 50.00 Hz	D	DVI
F13	1400 x 1050p @ 60.00 Hz	D	DVI
F14	1400 x 1050p @ 75.00 Hz	D	DVI
F15	1680 x 1050p @ 60.00 Hz	D	DVI
F16	1920 x 1080p @ 50.00 Hz	D	DVI
F17	1920 x 1080p @ 60.00 Hz	D	DVI
F18	2048 x 1080p @ 50.00 Hz	D	DVI
F19	2048 x 1080p @ 60.00 Hz	D	DVI
F20	1600 x 1200p @ 50.00 Hz	D	DVI
F21	1600 x 1200p @ 60.00 Hz	D	DVI
F22	1920 x 1200p @ 50.00 Hz	D	DVI
F23	1920 x 1200p @ 59.56 Hz	D	DVI
F24	2048 x 1200p @ 59.96 Hz	D	DVI
F29	1920 x 1080p @ 60.00 Hz	U	DVI
F30	1440 x 480i @ 60.05 Hz	H	HDMI; YUV444; YUV422; 2CH_AUD
F31	1440 x 576i @ 50.08 Hz	H	HDMI; YUV444; YUV422; 2CH_AUD
F32	640 x 480p @ 59.95 Hz	H	HDMI; YUV444; YUV422; 2CH_AUD
F33	720 x 480p @ 59.94 Hz	H	HDMI; YUV444; YUV422; 2CH_AUD
F34	720 x 576p @ 50.00 Hz	H	HDMI; YUV444; YUV422; 2CH_AUD

Mem	Resolution	Type	EDID features
F35	1280 x 720p @ 50.00 Hz	H	HDMI; YUV444; YUV422; 2CH_AUD
F36	1280 x 720p @ 60.00 Hz	H	HDMI; YUV444; YUV422; 2CH_AUD
F37	1920 x 1080i @ 50.04 Hz	H	HDMI; YUV444; YUV422; 2CH_AUD
F38	1920 x 1080i @ 50.00 Hz	H	HDMI; YUV444; YUV422; 2CH_AUD
F39	1920 x 1080i @ 60.05 Hz	H	HDMI; YUV444; YUV422; 2CH_AUD
F40	1920 x 1080i @ 60.05 Hz	H	HDMI; YUV444; YUV422; 2CH_AUD
F41	1920 x 1080p @ 24.00 Hz	H	HDMI; YUV444; YUV422; 2CH_AUD
F42	1920 x 1080p @ 25.00 Hz	H	HDMI; YUV444; YUV422; 2CH_AUD
F43	1920 x 1080p @ 30.00 Hz	H	HDMI; YUV444; YUV422; 2CH_AUD
F44	1920 x 1080p @ 50.00 Hz	H	HDMI; YUV444; YUV422; 2CH_AUD
F45	1920 x 1080p @ 59.94 Hz	H	HDMI; YUV444; YUV422; 2CH_AUD
F46	1920 x 1080p @ 60.00 Hz	H	HDMI; YUV444; YUV422; 2CH_AUD
F47	1920 x 1080p @ 60.00 Hz	U	HDMI; YUV444; YUV422; 2CH_AUD
F48	1920 x 1080p @ 60.00 Hz	U	HDMI; YUV444; YUV422; 8CH_AUD
F49	1920 x 1080p @ 60.00 Hz	U	HDMI; YUV444; YUV422; DC30; DC36; YUVDC; 8CH_AUD
F98	1280 x 720p @ 60.00 Hz	H	HDMI; YUV444; YUV422; 2CH_AUD; 3D
F99	1920 x 1080p @ 60.00 Hz	H	HDMI; YUV444; YUV422; 2CH_AUD; 3D
F100	1024 x 768p @ 60.00 Hz	H	HDMI; YUV444; YUV422; 2CH_AUD
F101	1280 x 1024p @ 50.00 Hz	H	HDMI; YUV444; YUV422; 2CH_AUD
F102	1280 x 1024p @ 60.02 Hz	H	HDMI; YUV444; YUV422; 2CH_AUD
F103	1280 x 1024p @ 75.02 Hz	H	HDMI; YUV444; YUV422; 2CH_AUD
F104	1600 x 1200p @ 50.00 Hz	H	HDMI; YUV444; YUV422; 2CH_AUD
F105	1600 x 1200p @ 60.00 Hz	H	HDMI; YUV444; YUV422; 2CH_AUD
F106	1920 x 1200p @ 59.56 Hz	H	HDMI; YUV444; YUV422; 2CH_AUD
F107	2560 x 1440p @ 59.95 Hz	H	HDMI; YUV444; YUV422; 2CH_AUD
F108	2560 x 1600p @ 59.86 Hz	H	HDMI; YUV444; YUV422; 2CH_AUD
F109	3840 x 2400p @ 24.00 Hz	H	HDMI; YUV444; YUV422; 2CH_AUD
F110	3840 x 2160p @ 24.00 Hz	H	HDMI; YUV444; YUV422; 2CH_AUD
F111	3840 x 2160p @ 25.00 Hz	H	HDMI; YUV444; YUV422; 2CH_AUD
F112	3840 x 2160p @ 30.00 Hz	H	HDMI; YUV444; YUV422; 2CH_AUD

Mem	Resolution	Type	EDID features
F118	3840 x 2160p @ 30.00 Hz	U	HDMI; YUV444; YUV422; 2CH_AUD
F119	3840 x 2160p @ 30.00 Hz	U	HDMI; YUV444; YUV422; 8CH_AUD
F120	3840 x 2160p @ 60.00 Hz	H	HDMI; YUV444; YUV422; YUV420; 2CH_AUD
F121	1440 x 1080p @ 59.91 Hz	H	HDMI; YUV444; YUV422; 2CH_AUD
F122	2560 x 2048p @ 59.98 Hz	H	HDMI; YUV444; YUV422; 2CH_AUD
F123	1280 x 800p @ 59.91 Hz	H	HDMI; YUV444; YUV422; 2CH_AUD
F124	1440 x 900p @ 59.90 Hz	H	HDMI; YUV444; YUV422; 2CH_AUD
F125	1366 x 768p @ 60.00 Hz	H	HDMI; YUV444; YUV422; 2CH_AUD
F126	1600 x 900p @ 59.98 Hz	H	HDMI; YUV444; YUV422; 2CH_AUD
F127	2048 x 1080p @ 60.00 Hz	H	HDMI; YUV444; YUV422; 2CH_AUD
F128	2560 x 1080p @ 60.00 Hz	H	HDMI; YUV444; YUV422; 2CH_AUD
F129	3440 x 1440p @ 24.99 Hz	H	HDMI; YUV444; YUV422; 2CH_AUD
F130	3440 x 1440p @ 29.99 Hz	H	HDMI; YUV444; YUV422; 2CH_AUD
F131	4096 x 2160p @ 25.00 Hz	H	HDMI; YUV444; YUV422; 2CH_AUD
F132	4096 x 2160p @ 30.00 Hz	H	HDMI; YUV444; YUV422; 2CH_AUD
F133	4096 x 2160p @ 60.00 Hz	4	HDMI; YUV444; YUV422; YUV420; 2CH_AUD
F134	3440 x 1440p @ 23.99 Hz	H	HDMI; YUV444; YUV422; 2CH_AUD
F135	4096 x 2160p @ 24.00 Hz	H	HDMI; YUV444; YUV422; 2CH_AUD
F136	3840 x 2400p @ 29.99 Hz	H	HDMI; YUV444; YUV422; 2CH_AUD
F137	3840 x 2160p @ 60.00 Hz	H	HDMI; HDMI2; YUV444; YUV422; 2CH_AUD
F138	3840 x 2160p @ 50.00 Hz	H	HDMI; HDMI2; YUV444; YUV422; 2CH_AUD
F139	3840 x 2160p @ 60.00 Hz	H	HDMI; HDMI2; YUV444; YUV422; YUV420; 2CH_AUD
F140	3840 x 2160p @ 60.00 Hz	H	HDMI; HDMI2; YUV444; YUV422; YUV420; 8CH_AUD
F141	4096 x 2160p @ 60.00 Hz	H	HDMI; HDMI2; YUV444; YUV422; 2CH_AUD
F142	4096 x 2160p @ 50.00 Hz	H	HDMI; HDMI2; YUV444; YUV422; 2CH_AUD
F143	4096 x 2160p @ 60.00 Hz	H	HDMI; HDMI2; YUV444; YUV422; YUV420; 2CH_AUD
F144	4096 x 2160p @ 60.00 Hz	H	HDMI; HDMI2; YUV444; YUV422; YUV420; 8CH_AUD
F145	2560 x 2048p @ 49.97 Hz	H	HDMI; YUV444; YUV422; 2CH_AUD
F146	3840 x 2160p @ 60.00 Hz	H	HDMI; HDMI2; YUV420; DC30; DC36; YUVDC; YUV420_DC30; YUV420_DC36; 2CH_AUD; HDR
F147	3840 x 2160p @ 60.00 Hz	H	HDMI; HDMI2; YUV444; YUV422; 2CH_AUD

Mem	Resolution	Type	EDID features
F148	3840 x 2160p @ 60.00 Hz	H	HDMI; HDMI2; YUV444; YUV422; 8CH_AUD
F154	3840 x 2160p @ 60.00 Hz	H	HDMI; HDMI2; YUV444; YUV422; YUV420; DC30; DC36; YUVDC; YUV420_DC30; YUV420_DC36; 2CH_AUD; HDR
F155	3840 x 2160p @ 60.00 Hz	H	HDMI; HDMI2; YUV444; YUV422; YUV420; DC30; DC36; YUVDC; YUV420_DC30; YUV420_DC36; 8CH_AUD; HDR

Legend

D: DVI EDID

H: HDMI EDID

U: Universal EDID, supporting many standard resolutions:

- **F29:** Universal EDID for DVI signals (no audio support).
- **F47:** HDMI EDID supporting PCM audio.
- **F48:** HDMI EDID supporting all type of audio.
- **F49:** HDMI EDID supporting all type of audio and deep color.
- **F89:** Universal EDID for analog signals (no audio support).
- **F118:** HDMI EDID supporting PCM audio and 4K@30 Hz signals.
- **F119:** HDMI EDID supporting all type of audio and 4K@30 Hz signals.

DiD (in column EDID features): with Display ID support

Please note that minor changes in the factory EDID list may be applied in further firmware versions.

12.5. Cable Wiring Guide

12.5.1. Serial Ports

The device is built with a 3-pole Phoenix connector. See the examples below of connecting to a DCE (Data Circuit-terminating Equipment) or a DTE (Data Terminal Equipment) type device:

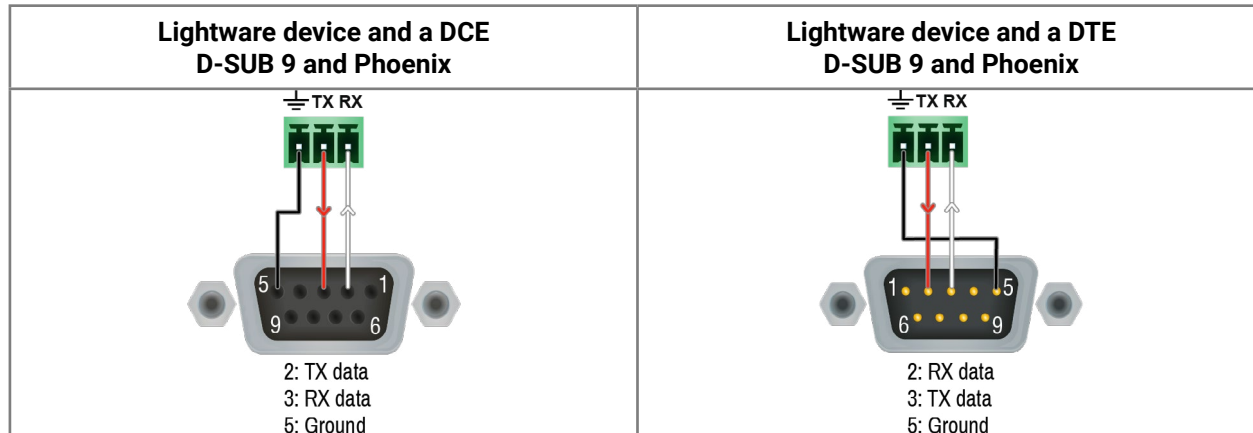

12.5.2. Audio Ports

Inputs and outputs of audio devices are symmetric or asymmetric. The main advantage of the symmetric lines is the better protection against the noise, therefore they are widely used in the professional audio industry. Symmetric audio is most often referred to as balanced audio, as opposed to asymmetric, which is referred to as unbalanced audio. Lightware products are usually built with 5-pole Phoenix connectors, so we would like to help users assembling their own audio cables. See the most common cases below.

ATTENTION! Symmetric and asymmetric lines can be linked with passive accessories (e.g. special cables), but in this case half of the line level is lost.

ATTENTION! There are numerous types of regularly used connector and cable types to connect audio devices. Please always make sure that a connector or cable fits your system before use.

ATTENTION! Never join the phase-inverted (negative, cold or -) poles (either right or left) to the ground or to each other on the output side, as this can damage the unit.

INFO: Use a galvanic isolation in case of a ground loop.

The Pinout of the 5-pole Phoenix Connector



Pin nr.	Signal
1	Left+
2	Left-
3	Ground
4	Right-
5	Right+

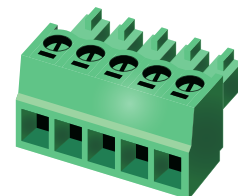

From Balanced Output to Unbalanced Input

Phoenix - 2 x 6.3 (1/4") TS

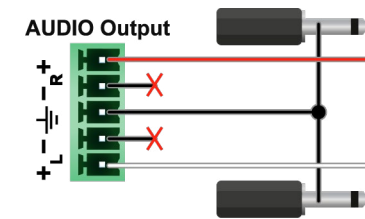

Phoenix - 2 x RCA

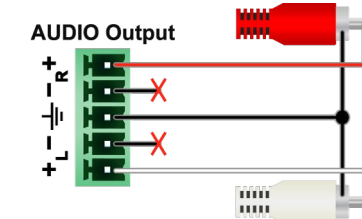

Phoenix - 3.5 (1/8") TRS

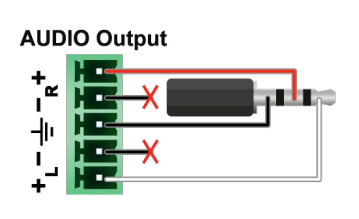

From Balanced Output to Balanced Input

Phoenix - 2 x 6.3 (1/4") TRS

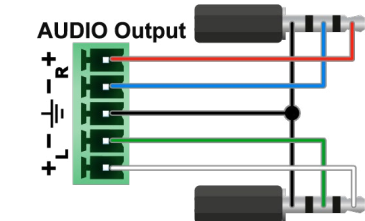

Phoenix - 2 x XLR

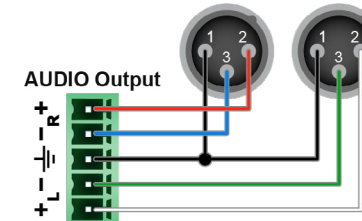

12.5.3. OCS Sensor

The switcher is supplied with a 3.81mm 3-pole 90° Reversed Gender Plug Phoenix® connector, which is used for connecting an occupancy sensor. The figure below is an example about how to connect a Leviton OCS10-M0W device. This sensor is a so-called 'active-high' type, thus the setup requires an external 1kR pull-down resistor between the input and the ground pins. If your sensor is 'open drain' type, the grey-colored wire and the resistor is not recommended to install.

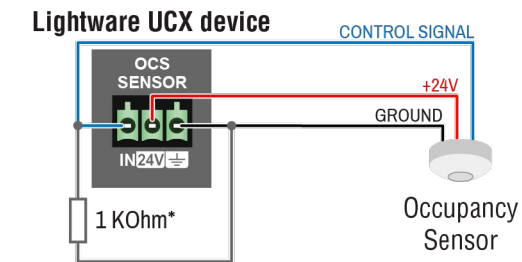

* The extra wire and the resistor are recommended only for 'active high' type sensors.

12.6. Mechanical Drawings

INFO: UCX-2x1-HC30, -HC40, UCX-2x2-H30, -H40, UCX-4x2-HC30, -HC40, UCX-4x3-HC40, DCX-2x1-HC10, DCX-3x1-HC20 models have the same size. Dimensions are in mm.

INFO: The -LCC models have the same values as non-LCC models.

UCX-2x1-HC30, -HC40, UCX-2x2-H30, -H40, UCX-4x2-HC30, -HC40, UCX-4x3-HC40, DCX-2x1-HC10, DCX-3x1-HC20 models

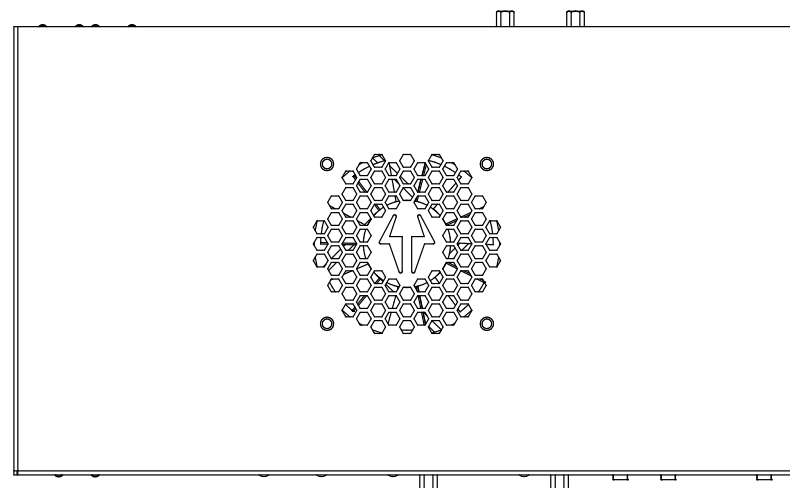
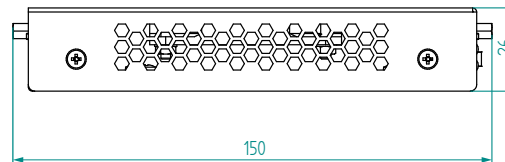
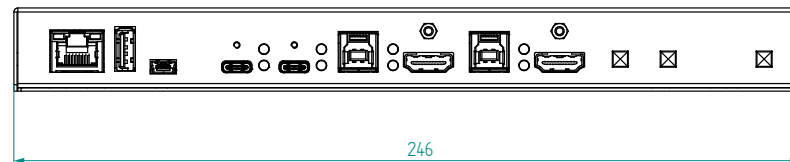
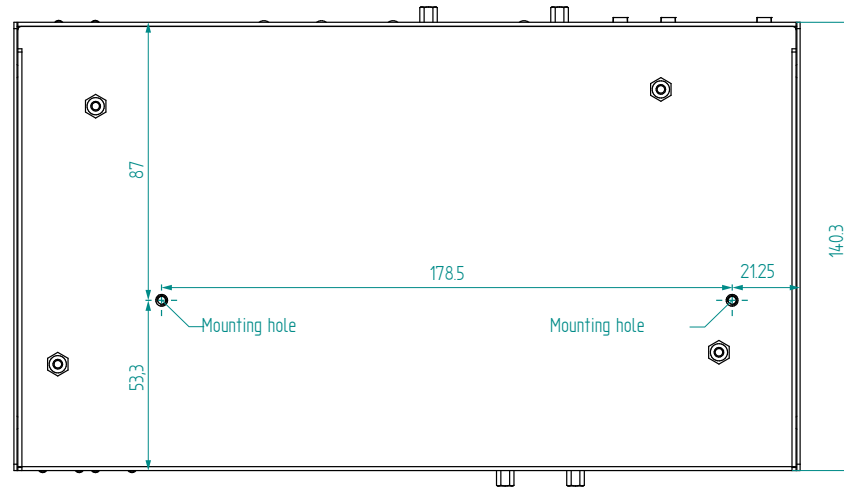

Power Supply Unit

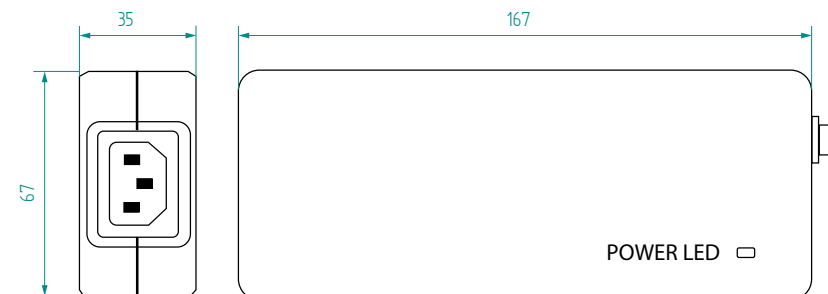

UCX-4x2-HC30D and UCX-4x3-HC40-BD model

INFO: UCX-4x2-HC30D, UCX-4x2-HC40D and UCX-4x3-HC40-BD models have the same size. Dimensions are in mm.

INFO: The -LCC models have the same values as non-LCC models.

UCX-4x2-HC30D, UCX-4x2-HC40D, UCX-4x3-HC40-BD models

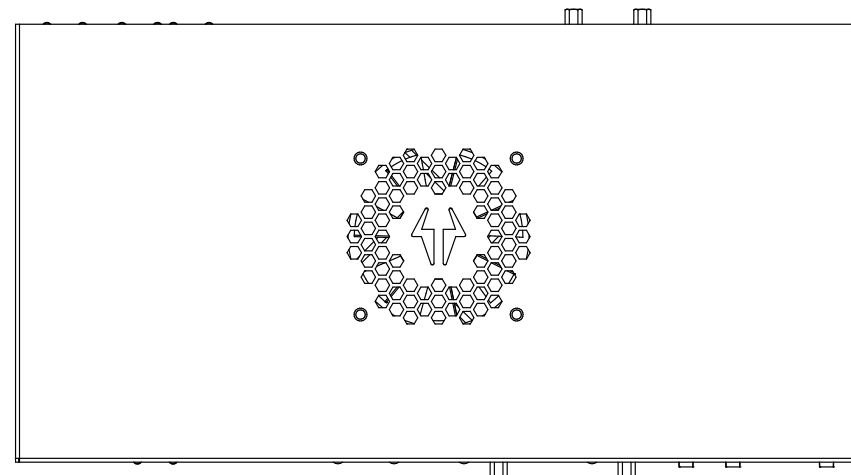
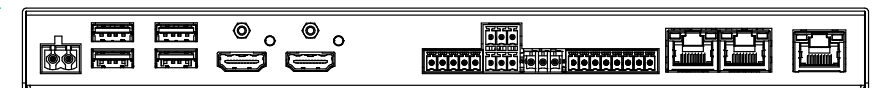
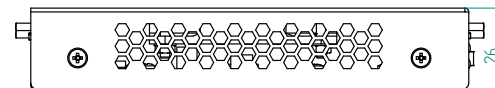
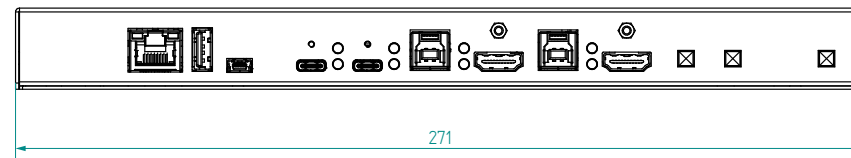
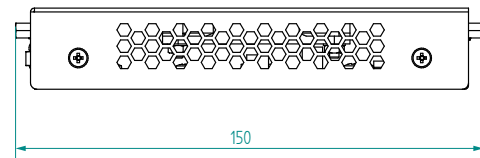
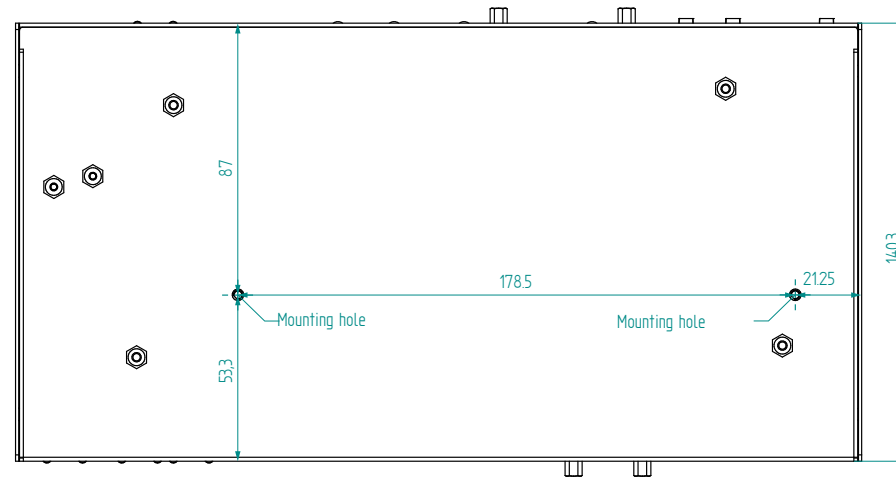

12.7. Content of the Backup File

The backup file contains numerous settings and parameters saved from the device. When the file is uploaded to a device, the following will be overwritten:

Audio / Video crosspoint settings
Mute state, Lock state, Crosspoint state
Autoselection (mode, port priority)
USB ports
Port name, Port type, Lock state, Crosspoint state, Power +5V mode
Autoselection (mode, port priority)
Lane management status, DisplayPort Alternate Mode policy, Power role setting, Power limit
USB-C video parameters (HDCP mode, Output signal type, Embedded audio mute state, Power +5V mode)
HDMI input ports
Video port name, Audio port name, HDCP setting
HDMI output ports
Port name, HDCP mode, HDMI mode, Power +5V mode
Analog audio port
Port name, Volume, Balance
Local serial port
Port name, RS-232 mode, Control protocol, Baud rate, Data bits, Stop bits, Parity
GPIO port
Port name, Direction, Level
OCS port
Sensor type, Port name
Network settings
Port name, Port status, PHY (speed and duplexity) mode
HTTP/HTTPS port status, HTTP/HTTPS Authentication status
LW3 port status, Serial port status
Authentication (password)
LARA full configuration
Further settings
Control lock status, Device label, Dark mode state, Dark mode delay
User EDID data (U1-U100), Emulated EDIDs by ports
Welcome screen status, Welcome screen parameters
Power supply output power limit

12.8. Firmware Compatibility Table

WARNING! Please do not downgrade the device with a not compatible firmware package, because it can cause malfunction in the device.

ATTENTION! The -HC40 and DCX-series models have separate firmware package files from the earlier models due to hardware differences. The firmware package for the other models is not compatible with these devices, however, software functionalities are the same in both firmware package files with the same version number. Please make sure you use the correct file for your device.

	v1.0.0b1	v1.1.0b7	v1.2.0b9	v2.1.0b2	v2.2.0b4	v2.6.0b6	v2.10.0b5	v2.11.0b2	v2.14.0b3
UCX-4x2-HC30	✓	✓	✓	✓	✓	✓	✓	✓	✓
UCX-4x2-HC30D	-	✓	✓	✓	✓	✓	✓	✓	✓
UCX-2x1-HC30	-	-	✓	✓	✓	✓	✓	✓	✓
UCX-2x2-H30	-	-	✓	✓	✓	✓	✓	✓	✓
UCX-4x3-HC40	-	-	-	✓	✓	✓	✓	✓	✓
DCX-2x1-HC10	-	-	-	-	✓	✓	✓	✓	✓
UCX-2x1-HC40	-	-	-	-	-	✓	✓	✓	✓
UCX-2x2-H40	-	-	-	-	-	✓	✓	✓	✓
UCX-4x2-HC40	-	-	-	-	-	✓	✓	✓	✓
UCX-4x3-HC40-BD	-	-	-	-	-	-	✓	✓	✓
UCX-4x2-HC40D	-	-	-	-	-	-	-	✓	✓
DCX-3x1-HC20	-	-	-	-	-	-	-	-	✓

12.9. Factory Default Settings

Parameter	UCX-4x2-HC30(D)/-HC40(D)	UCX-2x1-HC30/-HC40	UCX-2x2-H30/-H40	UCX-4x3-HC40(-BD)	DCX-2x1-HC10	DCX-3x1-HC20
Video port settings						
Connected source (O1/O2/O3)	I1/I3/-	I1/-/-	I1/I2/-	I1/I2/I3	I1/-/-	I1/-/-
Allowed HDCP Version (I1/I2/I3/I4)	1.4/1.4/2.2/2.2	2.2/2.2/-/-	2.2/2.2/-/-	1.4/1.4/2.2/2.2	2.2/2.2/-/-	2.2/2.2/1.4/-
Hotplug detect mode (HPD) at input ports	auto	auto	auto	auto	auto	auto
Display Welcome Screen Image	true	true	true	true	-	-
Display Welcome Screen Message	false	false	false	false	-	-
Output 5V mode / signal type	on / auto	on / auto	on / auto	on / auto	on / auto	on / auto
Output HDCP mode	auto	auto	auto	auto	auto	auto
Video autoselect	disabled					
Emulated EDID	Factory #47: Universal HDMI PCM					
Analog audio output port settings						
Volume	0 dB, 100%					
Balance	0 (center)					
Network settings						
Factory default IP address mode	DHCP					
Static IP address	192.168.0.100					
Static network mask	255.255.255.0					
Static gateway address	192.168.0.1					
Hostname	lightware-<serialno>					
LW3 protocol	enabled				-	enabled
HTTP, HTTPS	enabled					
HTTP, HTTPS authentication	disabled					
Authentication setting (user/password)	admin/<not set>					
VLAN preset	Transparent				-	-

USB port settings				
USB-C Power Limit	equal output power	-	equal output power	100W
DP Alternate Mode Policy	auto	-	auto	
Port Power Role	dual Role	-	dual Role	
Autoselect	follow video O1	-	follow video O1	
D1-D4 Power 5V Mode	auto	-	auto	-
RS-232 port settings				
RS-232 port	9600 BAUD, 8, N, 1		-	9600 BAUD, 8, N, 1
RS-232 serial over IP	enabled		-	enabled
GPIO port settings				
Output level	low		-	low
Direction	input		-	input
Occupancy sensor				
Sensor type	active high		-	active high
Miscellaneous				
Control lock	disabled			
Dark mode	disabled			
Automatic fan control	enabled			
User EDID memory	empty			

INFO: The -LCC models have the same values as non-LCC models.

12.10. Firmware Release Notes

The list below shows the released firmware packages with important notes.

v2.14.0b3

Release date: 2024-08-02

New feature:

- LARA 1.2.0b41 integration.
- DCX-3x1-HC20 is now officially supported.

Known issue:

- USB-C Ethernet connection instabilities.

v2.12.0b3

Release date: 2024-06-03

New feature:

- Two lane DisplayPort alternate mode is now available as well in case the four lane alternate mode setting is not supported.
- Critical issues have been fixed at the launch of the LARA configurations.
- A critical issue has been fixed at the USB-C Ethernet connection.
- LARA 1.2.0b40 integration.
- DCX-2x1-HC10 has LARA enabled now!
- New experimental LW3 node is available for testing now: EXPERIMENTAL/MEDIA/USB/Service. Enabled.
- USB access is available via service port for demonstrating and piloting the StreamDeck device support in LARA.
- Password history is now maintained on web authentication. The past ten passwords are no longer available to used.
- UCX-4x2-HC40D is now officially supported.
- FlowControl handling on serial port is now supported.

Known issue:

- USB-C Ethernet connection occasionally disconnects the connecting devices.

v2.10.0b5

Release date: 2024-02-26

New feature:

- Taurus UCX-4x3-HC40-BD is now officially supported.
- Bi-Directional Dante features are now integrated.
- LARA 1.2.0b37 integration.

v2.9.0b6

Release date: 2024-01-17

New feature:

- Disabled USB-C Ethernet ports are also disabling the ethernet bridge now.
- Time zones are available option now for timed events. A new optional NTP service has been introduced. A new LW API has been introduced for date/time settings. The device does observe now both the UTC and both the local times.
- Complete redesign of the WebLDC's session management. A new logout button has been introduced for logging out from the session. After 120 minutes the session will be closed and the user is going to be logged out automatically. After 15 minutes of inactivity the session will be closed also. 2 minutes prior to the inactivity logout the user has to option to confirm the willingness to keep using the system.
- LARA 1.2 integration.

v2.7.1b1

Release date: 2023-11-29

New feature:

- LARA 1.1.11 version update. For details please check the LARA release notes.

v2.6.0b6

Release date: 2023-09-21

New feature:

- Now, new V51 variants are supported: UCX-2x1-HC40, UCX-2x2-H40, UCX-4x2-HC40
- LARA 1.1.10 version upgrade

v2.5.0b6

Release date: 2023-08-15

New feature:

- 100W charging settings are available now on the user interface
- LARA v1.1.9 has been integrated. For more information please read the LARA release notes.

v2.4.0b1

Release date: 2023-07-03

Bugfix:

- Fixed device freeze during boot time caused by less than ~2sec power outages.

v2.2.3b4

Release date: 2023-05-09

Bugfix:

- Fixed unintended loss of configuration settings caused by non-standard (non-RFC) hostname.
- Fixed uncertainties in Welcome Screen provisioning.

v2.2.0b4

Release date: 2023-03-30

New feature:

- Unique SSL certificate management has been added to Network/Services page.
- Service settings have been separated from network setup.
- The admin password with the allowance of special characters must be at least 10 characters long.
- Stability improvements.
- LARA v1.1.6 has been integrated into Taurus v2.2.0. For more information please read LARA release notes. <https://go.lightware.com/lara-release-note-v2.2>

v2.1.1b3

Release date: 2023-03-09

Bugfix:

- Improved reliability of WelcomeScreen in case of running for more than 24 hours.
- Not allowing to restore from different hardware variant backups.
- Fixed LIVE LED functionality in DARK_MODE on HC40 hardware variants.
- Stability improvements.

v2.1.0b2

Release date: 2023-02-20

New feature:

- From this version on UCX-4x3-HC40 is supported
- LARA v1.1.5 has been integrated into Taurus Firmware v2.1.0. Cisco RS232 communication is available and Room Kit Mini is supported. For more information please visit: <https://go.lightware.com/lara-release-note-v2.1>

v2.0.0b5

Release date: 2023-02-06

New feature:

- 802.1X authentication protocol gives the Taurus UCX access to the protected network after authentication using EAP-MD5 or EAP-TLS.
- Taurus UCX can preserve device configuration after the firmware upgrade from v2.0.0 and above. Downgrading to Firmware version < v2.0.0 is not supported.
- Sensitive data (eg. passwords, certificates, etc.) are not included in the Taurus UCX configuration backup. New file format for backup/restore/bulk configuration functionalities.
- Hardening the password change functionality by enforcing to enter the old password.

- LARA v1.1.4 has been integrated into Taurus Firmware v2.0.0.

Known issue:

- Soft reboot of the Taurus / MMX2 takes longer by 2 minutes than usual. Hard reboot (e.g. a power cycle) is faster than the soft one

v1.6.2b2

Release date: 2022-12-08

Bugfix:

- Client OS no longer detects the disabled ethernet connection on USB-C port as an active network.
- Port Power Role settings are preserved in case of overcurrent or when disconnecting the USB-C cable.

Known issue:

- Soft reboot of the Taurus / MMX2 takes longer by 2 minutes than usual. Hard reboot (e.g. a power cycle) is faster than the soft one

v1.6.1b2

Release date: 2022-11-10

New feature:

- Advanced Ethernet configuration supports separate User/Control LANs and dedicated ports for BYOD devices.
- Basic authentication flow improvement
- Optimized log message flow

Bugfix:

- In overcurrent condition notebook charging is disabled only, all other functions are maintained.

Known issue:

- Soft reboot of the Taurus / MMX2 takes longer by 2 minutes than usual. Hard reboot (e.g. a power cycle) is faster than the soft one

v1.6.0b3

Release date: 2022-10-27

New feature:

- Advanced Ethernet configuration supports separate User/Control LANs and dedicated ports for BYOD devices.
- Optimized log message flow

Bugfix:

- In overcurrent condition notebook charging is disabled only, all other functions are maintained.

Known issue:

- Soft reboot of the Taurus / MMX2 takes longer by 2 minutes than usual. Hard reboot (e.g. a power cycle) is faster than the soft one

v1.5.1b2

Release date: 2022-09-15

Bugfix:

- LARA v1.1.1. has been integrated into Taurus v1.5.1. For more information please visit: <https://go.lightware.com/lara-release-note-v1.1.1>

Known issue:

- Soft reboot of the Taurus / MMX2 takes longer by 2 minutes than usual. Hard reboot (e.g. a power cycle) is faster than the soft one

v1.5.0b7

Release date: 2022-08-31

New feature:

- UserScripts can not be used from Firmware version 1.5.0, use LARA (Lightware Advanced Room Automation) configuration instead. LARA v1.1.0 has been integrated into Taurus v1.5.0. For more information, please visit <https://go.lightware.com/lara-release-note-v1.1.0b28>.
- Packages for Taurus UCX and MMX2 are separated from Firmware v1.5.0. Please download the specific firmware package for your product.
- Device label will not be overwritten when cloning configuration. Please ignore the warning in LDC/Bulk management.
- Stability improvements have been added.

Known issue:

- Soft reboot of the Taurus/MMX2 takes longer by 2 minutes than usual. Hard reboot (e.g. a power cycle) is faster than the soft one.

v1.4.3b1

Release date: 2022-07-20

Bugfix:

- Risk of "bootloop" after initial flashing -> fixed

v1.4.2b2

Release date: 2022-07-07

Bugfix:

- UCX-2x1-HC30: The USB-C bridge MAC addresses of all produced units were identical and may caused MAC collisions. Firmware 1.4.2 fixes this issue.

v1.4.1b2

Release date: 2022-06-09

Bugfix:

- Fixed video sign loss in case of switching between Input5 and Input1.
- Improved overcurrent protection for certain non-standrad notebooks. (In previous releases it could cause video sign loss.)
- Improved compatibility between Taurus and VADDIO USB Bridge.

v1.4.0b4

Release date: 2022-04-27

New feature:

- Basic CEC added (at HDMI outputs)
- WebLDC added
- 2x60W charge on PCB >= 2.4

Known issue:

- "Loss of video after I5" bug (to be fixed in next hotfix release)

v1.3.3b3

Release date: 2021-12-08

New feature:

- No need for factory reset after upgrading from 1.3.x
- Adding support for MMX2 - H20

Bugfix:

- Video layer freeze issue fixed

v1.3.2b1

Release date: 2021-11-05

New feature:

- Firmware support for PCB V2.3 added

Known issue:

- The experimental feature "Current measurement of USB device ports" does not work, so removed from LW3.

v1.3.1b1

Release date: 2021-11-02

Bugfix:

- "USB follows video" bug in v1.3.0b6 fixed

v1.3.0b6

Release date: 2021-10-22

New feature:

- support package improvement (cleaned up logging, LW3 tree saving)
- HDR EDIDs added to EDID list
- HDMI output audio mute function became available at the audio layer
- HDCP compatibility improvement (HDCP versions supported by the sink are shown)
- Supporting H20 product variants

Bugfix:

- robustness improvement of the upgrade procedure
- faster reboot after factory reset

v1.2.2b3

Release date: 2021-10-05

New feature:

- No factory reset needed on upgrading from 1.2.0

Bugfix:

- Inconrent Autoselect operation related to signal present going false for a short time (<1s) is fixed. This typically occurs during locking the screen in Windows.

v1.2.1b4

Release date: 2021-08-30

Bugfix:

- Inconrent Autoselect operation related to signal present going false for a short time (<1s) is fixed. This typically occurs during locking the screen in Windows.

v1.2.0b9

Release date: 2021-07-01

New feature:

- We recommend the update to the FW 1.2.0 only if you need some of the new features. The update will

cause Factory reset.

- Serial over Ethernet is supported
- Status LED functions, IdentifyMe and Dark mode
- Serial port is supported
- REST API is supported
- Special Push button functions (Enable HDCP, Factory Reset, Control Lock) are supported
- Basic IT security features (HTTPS, WSS) are available
- UCX-2x1-HC30 and UCX-2x2-H30 variants are supported

Known issue:

- UCX-2x1-HC30 and UCX-2x2-H30 are supported from FW 1.2.0. Uploading a FW package of version less than 1.2.0 renders these variants dysfunctional.
- No response to LW3 and REST API command SET V1/MANAGEMENT/LABEL.DeviceLabel
- IdentifyMe does not work in the LDC Device Discovery window. This function might not work in the favourite devices list. (Next LDC version will solve this issue)
- LDC 2.5.10b1 version supports only 6107 TCP connection. If the 6107 port is closed the LDC cannot connect to the device. If Device Discovery detects a product with 6107 port closed then it will ask for permission to open it. This function might not work in the favourite devices list. Next LDC version will be able to connect using WSS (443).
- Crosspoint view of the LDC only reflects the crosspoint mute property (/V1/MEDIA/AUDIO/XP/O1.Mute) but it won't show Embedded audio mute state of the port (/V1/MEDIA/VIDEO/O1.EmbeddedAudioMute)
- Network settings of the device (like IP address) can be changed via LDC device discovery window. Changes take effect as expected but the displayed value of these properties follows the changes only after rebooting the device.
- It is not possible to clone configurations between different variants but the error message might be missing

v1.1.1b1

Release date: 2021-04-19

Bugfix:

- Fixed DP Alternate mode interoperability issues with various kinds of USB Type-C devices

v1.1.0b7

Release date: 2021-03-04

New feature:

- New port properties
- Welcome Screen, OCS and GPIO properties now available in LW3
- UCX-4x2-HC30D variant is supported

- Configuration cloning
- Autoselect functionalities added to USB layer

Bugfix:

- The following properties can be set to On or Off mode: /V1/MEDIA/VIDEO/O1.Output5VMode /V1/MEDIA/VIDEO/O2.Output5VMode Auto mode will be available in a future release.
- Ethernet port P5 is counting TX Ethernet packets even if there is no connection. /MEDIA/ETHERNET/P5/COUNTERS.TxCounter Ethernet packet transmission on P5 is not affected by this issue. This Ethernet port works as expected other than the incorrect TX counter value.
- If a USB Host without DisplayPort Alterante mode support is connected to one of the USB Type-C connectors, then the ActiveAltMode property erroneously reads as DP. /V1/MEDIA/USB/U1.ActiveAltMode=DP This issue causes Lightware Device Controller to erroneously display a yellow "DP" indicator on the port panel, which means the connection successfully entered DisplayPort Alterante mode. The following property describing the DisplayPort Alterante mode capability of the connected Host works as expected. /V1/MEDIA/USB/U1.HostSupportsDpAltMode=false USB and Displayport Data transmission is not affected.
- An external control system using LW3 protocol subscribed to an HDMI output node OPEN /V1/MEDIA/VIDEO/O1 might not receive all CHG messages related to the presence of embedded audio on the output. For example if the video crosspoint switches between two sources: one with- and one without embedded audio, then the following CHG messages might be missing: CHG /V1/MEDIA/VIDEO/O1.EmbeddedAudioPresent=false CHG /V1/MEDIA/VIDEO/O1.EmbeddedAudioPresent=true Transmission of the embedded audio stream from input to output is unaffected. Muting the audio also works as expected.
- No fading at the analog audio output during signal switching
- VCONN is not supplied by USB Type-C interface of the product, if the port partner sends a Vconn Swap command via Power Delivery Protocol over the Communication Channel. USB Type-C active cables or VCONN powered peripherals require VCONN. These cables or peripherals won't work in the above case. Also communicating with e-Markers of cables will not be possible. Charging, USB and DisplayPort functions using passive cables is not affected. The product has a strong preference toward becoming a Power Source upon connecting a device. The product will source VBUS and VCONN most of the times, therefore Vconn Swap command would only result in the connected device sourcing the Vconn, and avoiding this issue.
- Properties in /SYS node may change in future releases.
- HPD signal is activated with up to 100ms delay compared to the 5V signal. This might cause compatibility issue with some devices.
- If I1 input is selected by Autoselect after I5 input, the value of the following property might become invalid: /MEDIA/VIDEO/I1/HDCP.ActiveHdcpVersion The video transmission is not affected, only the

displayed value of HDCP version is compromised.

- Reporting the presence of embedded audio on the HDMI output is not reliable./MEDIA/VIDEO/O1.EmbeddedAudioPresent The property might read true while there is no embedded audio on the connected input port. Transmission of the embedded audio stream from input to output is unaffected. Muting the audio also works as expected.

Known issue:

- Properties of Audio XP do not reflect the limitations of the video XP. If I5 is in use on the video layer, neither the video nor the audio content of I1 cannot be used.
- Locked audio or video ports can be muted or unmuted.
- 192kHz multichannel audio is only delivered as stereo to the outputs. Lower sampling rates are not affected.
- SwitchAll method cannot be used to disconnect all outputs. Switch method can be used instead. switchAll(0) method does not work. switch(0:01;0:02) works as expected.

v1.0.1b1

Release date: 2020-12-09

Bugfix:

- Improved ZIP file upload

v1.0.0b6

Release date: 2020-11-19

Known issue:

- No fading at the analog audio output during signal switching
- The following properties can be set to On or Off mode: /V1/MEDIA/VIDEO/O1.Output5VMode /V1/MEDIA/VIDEO/O2.Output5VMode Auto mode will be available in a future release.
- Reporting the presence of embedded audio on the HDMI output is not reliable./MEDIA/VIDEO/O1.EmbeddedAudioPresent The property might read true while there is no embedded audio on the connected input port. Transmission of the embedded audio stream from input to output is unaffected. Muting the audio also works as expected.
- VCONN is not supplied by USB Type-C interface of the product, if the port partner sends a Vconn Swap command via Power Delivery Protocol over the Communication Channel. USB Type-C active cables or VCONN powered peripherals require VCONN. These cables or peripherals won't work in the above case. Also communicating with e-Markers of cables will not be possible. Charging, USB and DisplayPort functions using passive cables is not affected. The product has a strong preference toward becoming a Power Source upon connecting a device. The product will source VBUS and VCONN most of the times, therefore Vconn Swap command would only result in the connected device sourcing the Vconn, and avoiding this issue.
- Properties in /SYS node may change in future releases.

- HPD signal is activated with up to 100ms delay compared to the 5V signal. This might cause compatibility issue with some devices.
- If I1 input is selected by Autoselect after I5 input, the value of the following property might become invalid: /MEDIA/VIDEO/I1/HDCP.ActiveHdcpVersion The video transmission is not affected, only the displayed value of HDCP version is compromised.
- Properties of Audio XP do not reflect the limitations of the video XP. If I5 is in use on the video layer, neither the video nor the audio content of I1 cannot be used.
- Ethernet port P5 is counting TX Ethernet packets even if there is no connection. /MEDIA/ETHERNET/P5/COUNTERS.TxCounter Ethernet packet transmission on P5 is not affected by this issue. This Ethernet port works as expected other than the incorrect TX counter value.
- If a USB Host without DisplayPort Alterante mode support is connected to one of the USB Type-C connectors, then the ActiveAltMode property erroneously reads as DP. /V1/MEDIA/USB/U1.ActiveAltMode=DP This issue causes Lightware Device Controller to erroneously display a yellow "DP" indicator on the port panel, which means the connection successfully entered DisplayPort Alterante mode. The following property describing the DisplayPort Alterante mode capability of the connected Host works as expected. /V1/MEDIA/USB/U1.HostSupportsDpAltMode=false USB and Displayport Data transmission is not affected.
- An external control system using LW3 protocol subscribed to an HDMI output node OPEN /V1/MEDIA/VIDEO/O1 might not receive all CHG messages related to the presence of embedded audio on the output. For example if the video crosspoint switches between two sources: one with- and one without embedded audio, then the following CHG messages might be missing: CHG /V1/MEDIA/VIDEO/O1.EmbeddedAudioPresent=false CHG /V1/MEDIA/VIDEO/O1.EmbeddedAudioPresent=true Transmission of the embedded audio stream from input to output is unaffected. Muting the audio also works as expected.
- 192kHz multichannel audio is only delivered as stereo to the outputs. Lower sampling rates are not affected.

12.11. Hashtag Keyword List

This user's manual contains keywords with hashtags (#) to help you find the relevant information as quick as possible.

The format of the keywords is the following:

#<keyword>

The usage of the keywords: use the **Search** function (Ctrl+F / Cmd+F) of your PDF reader application, type the # (hashtag) character and the wished keyword.

The #new special keyword indicates a new feature/function that has just appeared in the latest firmware or software version.

Example

#dhcp

This keyword is placed at the DHCP (dynamic IP address) setting in the front panel operation, the Lightware Device Controller (LDC) and the LW3 programmer's reference section.

The following list contains all hashtag keywords placed in the document with a short description belonging to them. The list is in **alphabetical order** by the hashtag keywords.

Hashtag Keyword ↓	Description
#advancedview	Advanced view / Terminal window
#alternatemode	Displayport Alternate mode settings
#analogaudio	Analog audio related settings
#authentication	Authentication settings
#autoselect	Autoselect feature settings
#balance	Balance (for analog audio) setting
#buttonlock	Front panel button lock setting
#cablediagnostics	Cable diagnostics tool in LDC
#cec	CEC-related settings
#crosspoint	Crosspoint switch setting
#devicelabel	Device label
#dhcp	Dynamic IP address (DHCP) setting
#diagnostic	Failure diagnostic related tool/information
#displayportalternatemode	Displayport Alternate mode settings
#dpaltmode	Displayport Alternate mode settings
#edid	EDID related settings
#factory	Factory default settings
#fips	FIPS related information
#firmwareversion	Firmware version query

Hashtag Keyword ↓	Description
#framedetector	Frame detector in LDC
#hdcpc	HDCP-encryption related setting
#http	Http-related settings
#https	Https-related settings
#ipaddress	IP address related settings
#label	Device label
#lock	Port lock setting
#lockbutton	Front panel button lock setting
#log	System log
#mute	Port mute setting
#network	Network (IP address) related settings
#portstatus	Source/destination port status query
#power	Power sending settings
#producttype	Product type query
#reboot	Restarting the device
#restart	Restarting the device
#rs232	RS-232 related settings
#rs-232	RS-232 related settings
#security	Network security settings
#serial	RS-232 related settings
#serialnumber	Serial number query
#signaltype	HDMI/DVI signal type setting
#status	Status query
#switch	Crosspoint switch setting
#systemlog	System log
#terminal	Advanced view / Terminal window
#testpattern	Test pattern (no sync screen) settings
#unlock	Port unlock setting
#unmute	Port unmute setting
#usb	USB 2.0 interface-related settings
#usbc	USB-C interface-related settings
#volume	Volume (for analog audio) setting
#welcomescreen	Welcome screen settings
#password	Password setting

12.12. Further Information

Limited Warranty Statement

1. Lightware Visual Engineering PLC (Lightware) warrants to all trade and end user customers that any Lightware product purchased will be free from manufacturing defects in both material and workmanship for three (3) years from purchase unless stated otherwise below. The warranty period will begin on the latest possible date where proof of purchase/delivery can be provided by the customer. In the event that no proof can be provided (empty 'Date of purchase' field or a copy of invoice), the warranty period will begin from the point of delivery from Lightware.

1.1. 25G and MODEX product series will be subject to a seven (7) year warranty period under the same terms as outlined in this document.

1.2. If during the first three (3) months of purchase, the customer is unhappy with any aspect of a Lightware product, Lightware will accept a return for full credit.

1.3. Any product that fails in the first six (6) months of the warranty period will automatically be eligible for replacement and advanced replacement where available. Any replacements provided will be warranted for the remainder of the original unit's warranty period.

1.4. Product failures from six (6) months to the end of the warranty period will either be repaired or replaced at the discretion of Lightware. If Lightware chooses to replace the product, then the replacement will be warranted for the remainder of the original unit's warranty period.

2. The above-stated warranty and procedures will not apply to any product that has been:

2.1. Modified, repaired or altered by anyone other than a certified Lightware engineer unless expressly agreed beforehand.

2.2. Used in any application other than that for which it was intended.

2.3. Subjected to any mechanical or electrical abuse or accidental damage.

2.4. Any costs incurred for repair/replacement of goods that fall into the categories above (2.1., 2.2., 2.3.) will be borne by the customer at a pre-agreed figure.

3. All products to be returned to Lightware require a return material authorization number (RMA) prior to shipment, and this number must be clearly marked on the box. If an RMA number is not obtained or is not clearly marked on the box, Lightware will refuse the shipment.

3.1. The customer will be responsible for in-bound, and Lightware will be responsible for out-bound shipping costs.

3.2. Newly repaired or replaced products will be warranted to the end of the originally purchased product's warranty period.

Document Revision History

Rev.	Release date	Changes	Editor
1.0	19.11.2020	Initial version	Judit Barsony
:			
1.16	16.12.2022	Bulk management information updated	Nikolett Keindl
1.17	09.02.2023	802.1x authentication sections added, basic authentication information updated, firmware update options added, specifications updated, minor corrections	Nikolett Keindl
1.18	23.02.2023	REST API chapter updated, release notes updated	Nikolett Keindl
1.19	05.04.2023	UCX-4x3-HC40 and DCX-2x1-HC10 models added, LDC chapter updated, SSL certificate upload added, Update REST API sections added, minor corrections	Nikolett Keindl
1.20	06.06.2023	Host name setting adjusted	Nikolett Keindl
1.21	10.07.2023	100W charging ability over one USB-C port added	Nikolett Keindl
1.22	21.09.2023	Power tab added in LDC chapter; -H(C)40 models added	Nikolett Keindl
1.23	25.01.2024	UCX-4x3-HC40-BD model added, Specifications updated, Built-in Web chapter added, other minor changes	Nikolett Keindl
1.24	04.03.2024	Dante functionality updated, minor corrections	Nikolett Keindl
1.25	10.04.2024	Password authentication updated, minor corrections	Nikolett Keindl
1.26	09.08.2024	UCX-4x2-HC40D variant added, DCX-3x1-HC20 variant added, CEC control options over LW3 added, FIPS 140-2 chapter added, Powering options chapter updated, Port Numbering chapter updated, minor corrections	Nikolett Keindl

Contact Us

sales@lightware.com

+36 1 255 3800

support@lightware.com

+36 1 255 3810

Lightware Visual Engineering PLC.

Peterdy 15, Budapest H-1071, Hungary

www.lightware.com

©2024 Lightware Visual Engineering. All rights reserved. All trademarks mentioned are the property of their respective owners. Specifications subject to change without notice.